



August 16, 2021

NOTICE

The Board of Directors of the Kaweah Delta Health Care District will meet in the Kaweah Health Lifestyle Fitness Center Conference Rooms on Tuesday August 17, 2021 beginning at 4:00PM in a special open Board of Directors meeting.

All Kaweah Delta Health Care District regular board meeting and committee meeting notices and agendas are posted 72 hours prior to meetings (special meetings are posted 24 hours prior to meetings) in the Kaweah Health Medical Center, Mineral King Wing entry corridor between the Mineral King lobby and the Emergency Department waiting room.

The disclosable public records related to agendas can be obtained by contacting the Board Clerk at Kaweah Health Medical Center – Acequia Wing, Executive Offices (Administration Department) {1st floor}, 400 West Mineral King Avenue, Visalia, CA via phone 559-624-2330 or email: cmoccio@kdhcd.org, or on the Kaweah Delta Health Care District web page <http://www.kaweahhealth.org>.

KAWEAH DELTA HEALTH CARE DISTRICT
Garth Gipson, Secretary/Treasurer

A handwritten signature in black ink that reads "Cindy Moccio". The signature is written in a cursive, flowing style.

Cindy Moccio
Board Clerk / Executive Assistant to CEO

DISTRIBUTION:
Governing Board
Legal Counsel
Executive Team
Chief of Staff

www.kaweahhealth.org



KAWEAH DELTA HEALTH CARE DISTRICT SPECIAL BOARD OF DIRECTORS MEETING

Kaweah Health Lifestyle Fitness Center Conference Rooms
5105 W. Cypress Avenue, Visalia, CA

Tuesday August 17, 2021
OPEN MEETING AGENDA {4:00PM}

1. **CALL TO ORDER**
2. **APPROVAL OF AGENDA**
3. **PUBLIC PARTICIPATION** – Members of the public may comment on agenda items before action is taken and after it is discussed by the Board. Each speaker will be allowed five minutes. Members of the public wishing to address the Board concerning items not on the agenda and within the jurisdictions of the Board are requested to identify themselves at this time. For those who are unable to attend the beginning of the Board meeting during the public participation segment but would like to address the Board, please contact the Board Clerk (Cindy Moccio 559-624-2330) or cmoccio@kaweahhealth.org to make arrangements to address the Board.
4. **LEGISLATIVE UPDATE** – Review relative to legislative requirements.
Gary Herbst– Chief Executive Officer
5. **OPTIONS FOR REPLACING THE MINERAL KING WING** – Review of two options including discussions relative to design, costs, [financing](#) and debt capacity.
Gary Herbst- Chief Executive Officer, Marc Mertz- Vice President, Chief Strategy Officer and Kevin Morrison, Director of Facilities Planning
6. **COMMUNITY FEEDBACK REGARDING DESIGN AND FUNDING OPTIONS** – Review of the community focus groups, [employee survey](#), medical staff survey, and community survey.
Marc Mertz- Vice President, Chief Strategy Officer and Adam Probolsky - Probolsky Research
7. **PROPOSED SCHEDULE / NEXT STEPS** – Discussion and review of decision, construction design, community education plan, and advocacy.
Marc Mertz, Vice President, Chief Strategy Officer and Deborah Volosin, Director of Community Engagement
8. **ADJOURN**
In compliance with the Americans with Disabilities Act, if you need special assistance to participate at this meeting, please contact the Board Clerk (559) 624-2330. Notification 48 hours prior to the meeting will enable the District to make reasonable arrangements to ensure accessibility to the Kaweah Delta Health Care District Board of Directors meeting.

*Mike Olmos – Zone I
Board Member*

*Lynn Havard Mirviss – Zone II
Vice President*

*Garth Gipson – Zone III
Secretary/Treasurer*

*David Francis – Zone IV
President*

*Ambar Rodriguez – Zone V
Board Member*

EXHIBIT 4

OPTION 1: TWO TOWERS / 2 PHASES

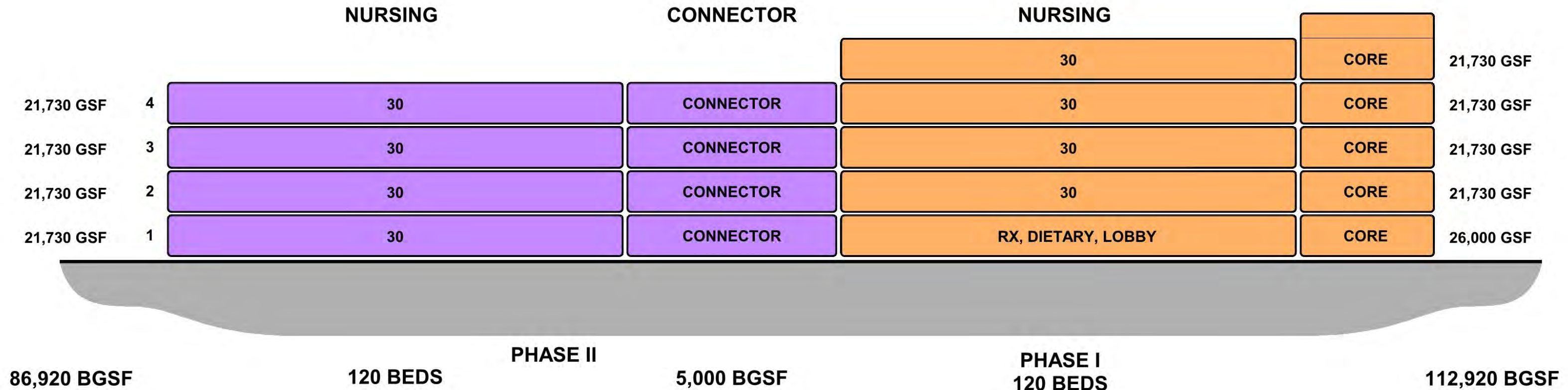

Phase 1 : 5-Storeys, 120 beds, Pharmacy, Dietary, Lobby, 452-car Parking Structure
: Construction Start mid 2026 - Completion by January 2030
: \$318.5 Million (\$231 M 2020 cost + 4.5% yearly escalation to 2027 mid-point of construction+ EIR)

Phase 2 : 4-storeys, 120 beds, 348-car Parking Structure
: Construction Start 2036 - Completion by January 2040
: \$365 Million (\$170 M 2020 cost + 4.5% yearly escalation to 2037 mid-point of construction + EIR)

JOHNSON STREET

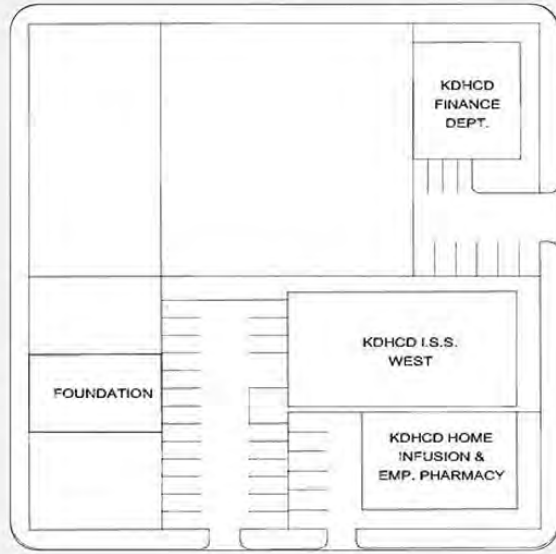

WILLIS STREET

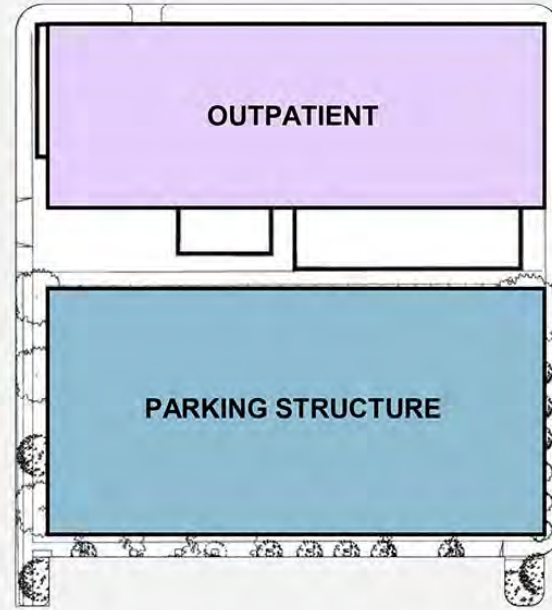

WEST STREET



LOCUST STREET

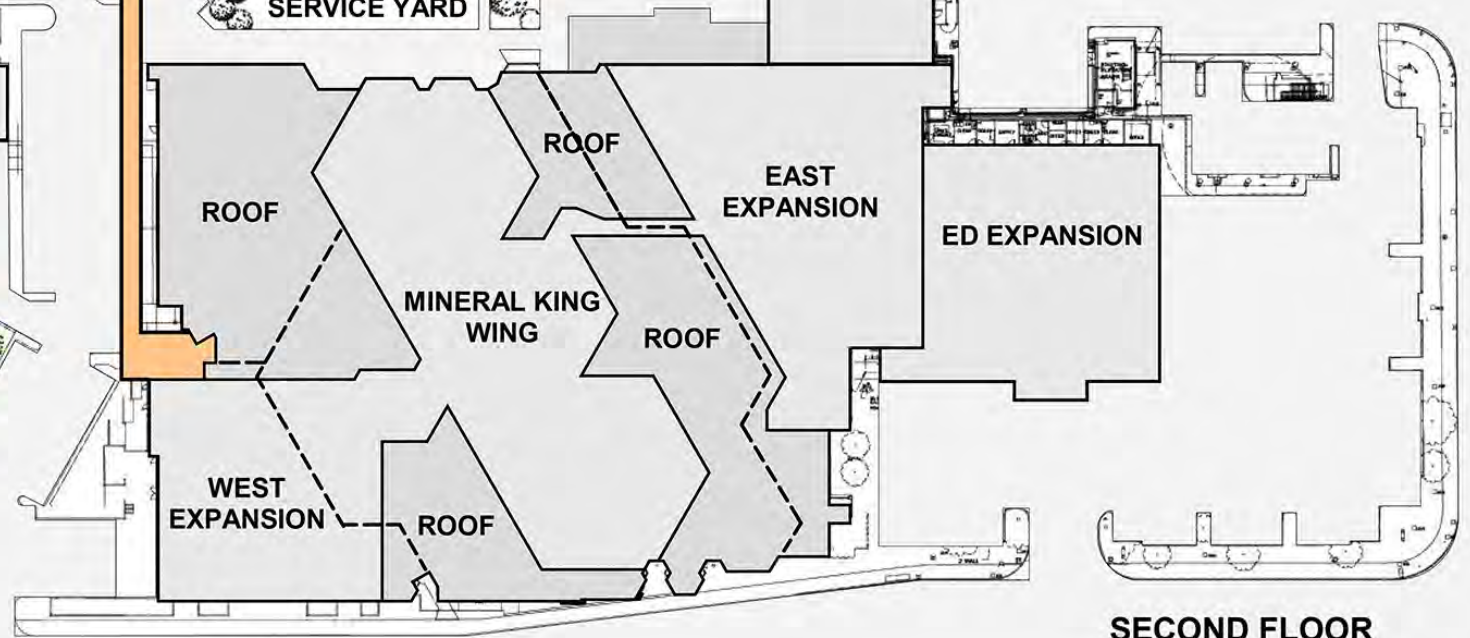
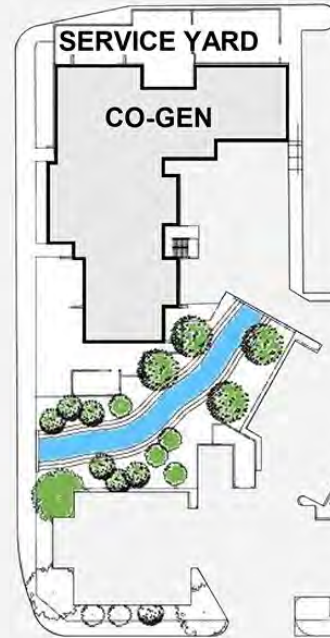
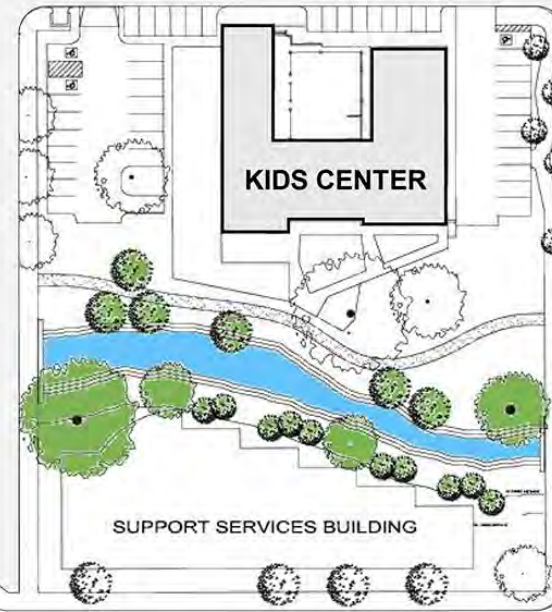
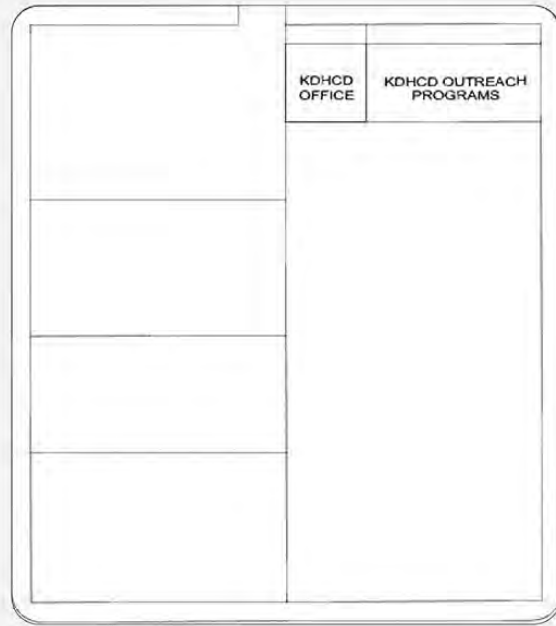

MINERAL KING AVENUE

SECOND FLOOR

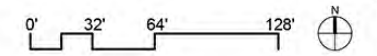

EXHIBIT 4

OPTION 1 - SITE PLAN

EXHIBIT 4

OPTION 2: ONE TOWER / 2 PHASES

21,730 GSF	9	SHELL	CORE	30
21,730 GSF	8	SHELL	CORE	30
21,730 GSF	7	SHELL	CORE	30
21,730 GSF	6	SHELL	CORE	30
21,730 GSF	5	BED	CORE	30
21,730 GSF	4	BED	CORE	30
21,730 GSF	3	BED	CORE	30
21,730 GSF	2	BED	CORE	30
26,000 GSF	1	RX, DIETARY, LOBBY	CORE	
199,840 BGSF				
				PHASE I 120 BEDS
				PHASE II 120 BEDS FILLED SHELL

Phase 1 : 9-Storeys (4 shelled), 120 beds, Pharmacy, Dietary, Lobby, 500-car Parking Structure

: Construction Start mid 2026 - Completion by January 2030

: \$440 Million (\$319 M 2020 cost + 4.5% yearly escalation to 2027 mid-point of construction + EIR)

Phase 2 : Infill 4-storeys, 120 beds

: Construction Start 2036 (tentative) - Completion January 2040

: \$101.5 Million (\$48 M 2020 cost + 4.5% yearly escalation to 2037 mid-point of construction)

JOHNSON STREET

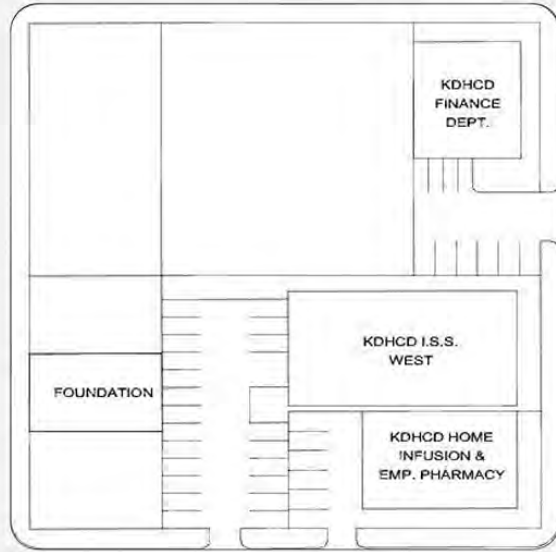

WILLIS STREET

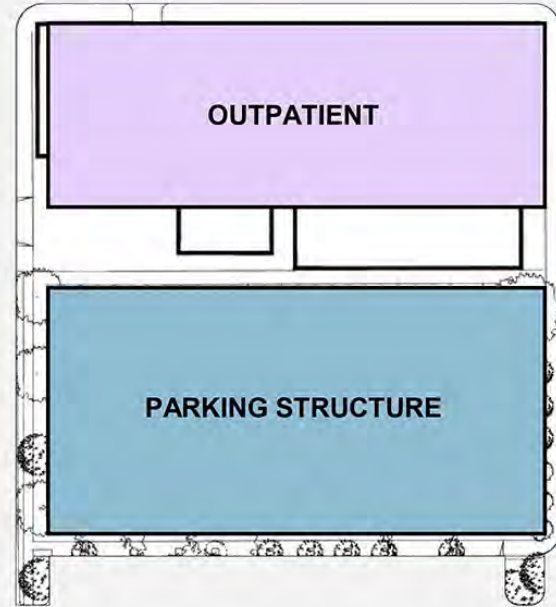

WEST STREET

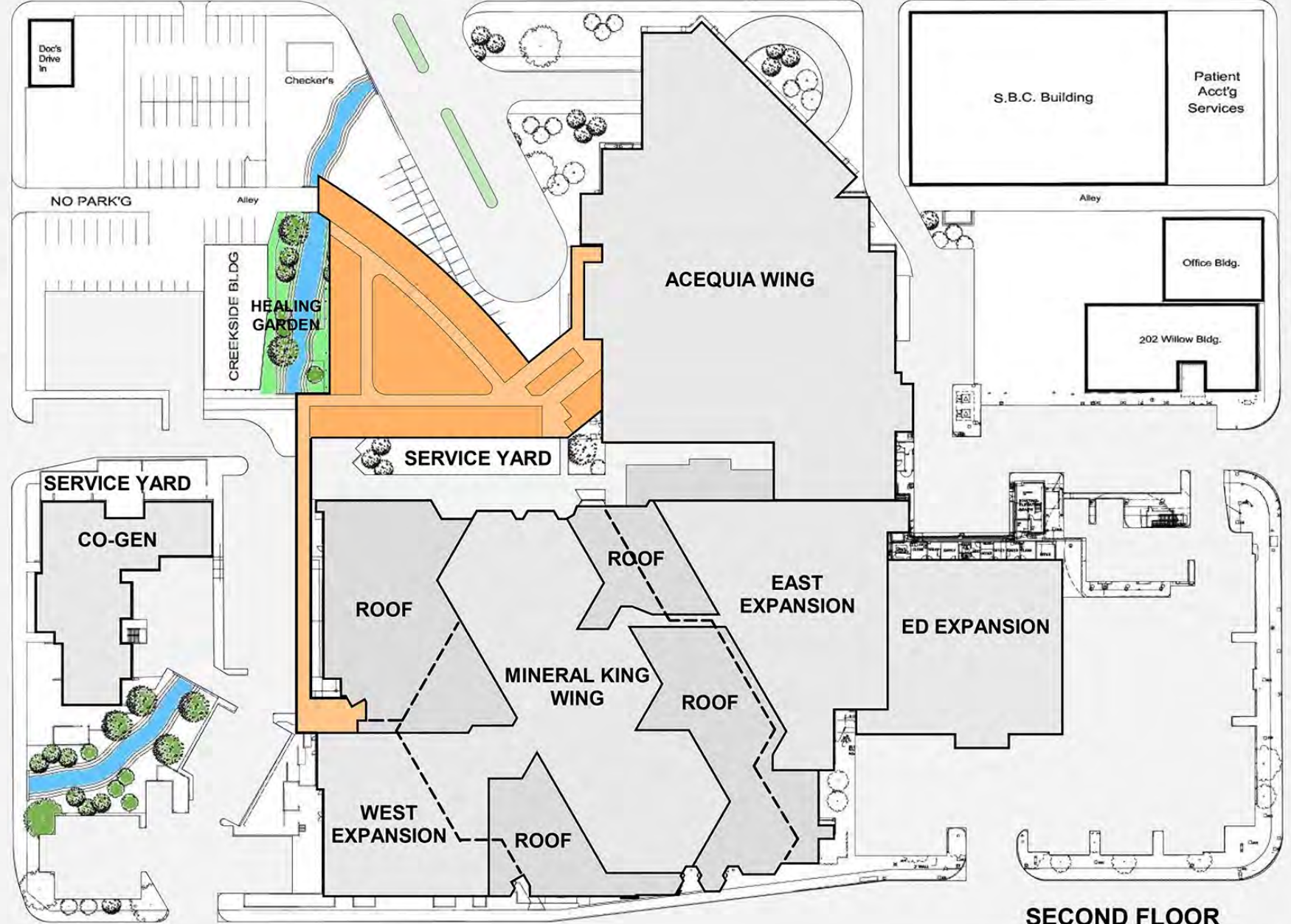

LOCUST STREET

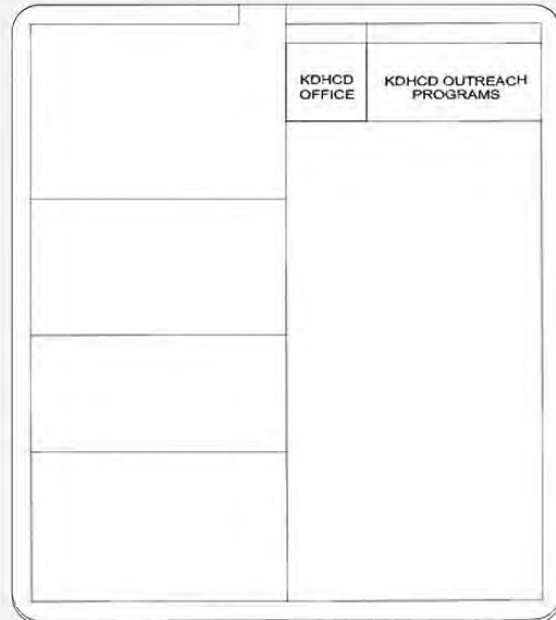

MINERAL KING AVENUE

SECOND FLOOR

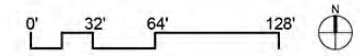

EXHIBIT 4

OPTION 2 - SITE PLAN

2021 MASTER PLAN - PRELIMINARY IMPLEMENTATION SCHEDULE

	Responsible	DUR.	DATES	2021	2022	2023	2024	2025	2026	2027	2028	2029	2030
A.	SB 1953 SEISMIC LAW COMPLIANCE- Replacement Beds Phase 1 (120 beds)												
A.1	BOARD APPROVAL OF TOWER-PARKING MASTER PLAN	KH	2 mos	9/2021 - 10/2021									
A.2	COMPLETE TOWER-PARKING MASTER PLAN & COST ESTIMATE	RBB	4 mos	11/2021 - 2/2022									
A.3	BOARD ACCEPTANCE & APPROVAL OF TOWER-PARKING BUDGET	KH		2/2022									
A.4	RFP & Pre-Qualification of Design Team for PH1 design-build bridging documents	KH /PM	11 mos	2/2022 - 12/2022									
A.5	Develop/complete design-build bridging packages <i>(start after G.O. Bond)</i>	KH/PM/A-E	7 mos	1/2023 - 7/2023									
A.6	RFQ/shortlist/bid/ award the Phase 1 (PH1) Design-Build Contract	KH/PM/A-E	13 mos	7/2023 - 7/2024									
A.7	TOWER PH1- Construction documents/OSHPD review/building permit	PM/DB/KH	38 mos	8/2024 - 9/2027									
A.8	TOWER PH1- Construction / certificate of occupancy	PM/DB/KH	38 mos	8/2026 - 9/2029									
A.9	TOWER PH1- Close-out /Licensing / move-in/patient-ready	KH/PM/DB	4 mos	9/2029 - 12/2029									
A.10	TOWER PH1 OPEN			1/2030									
A.11	Parking PH1- Construction documents/City review/ building permit	PM/DB/KH	14 mos	1/2023 - 2/2024									
A.12	Parking PH1- Construction / certificate of occupancy / OPEN	PM/DB/KH	16 mos	3/2024 - 6/2025									
A.13	Environmental Impact Report and City entitlements	PM/DB/KH	24 mos	1/2023 - 12/2024									
B.	SB 1953 SEISMIC LAW COMPLIANCE- NPC 5 Upgrades (non-structural performance category 5)												
B.1	Prepare/submit to OSHPD non-structural evaluation of buildings	KH /PM/A-E	10 mos	1/2023 - 10/2023	submit deadline 1/2024								
B.2	Construction documents/ OSHPD review/ building permit	KH/PM/ A-E	36 mos	1/2024 - 12/2025	submit deadline 1/2026								
B.3	Construction / certificate of occupancy / NPC 5 certification	KH/PM/ A-E	36 mos	1/2027 - 12/2029									
C.	SB 1953 SEISMIC LAW COMPLIANCE- 1969 Mineral King Bldg SPC-4D upgrade (if extension denied)												
C.1	Complete the SPC-4D seismic analysis / shake test/OSHPD approval	KH /PM/A-E	36 mos	7/2022 - 12/2024									
C.2	SPC-4D upgrade construction documents/ OSHPD review/ building permit	KH/PM/ A-E	30 mos	1/2025 - 6/2027									
C.3	Construction / certificate of occupancy / SPC-4D certification	KH/PM/ A-E	30 mos	7/2027 - 12/2029									
D.	GENERAL OBLIGATION BOND CAMPAIGN AND ELECTION												
D.1	COMMUNITY ENGAGEMENT AND EDUCATION CAMPAIGN	KH /C/ PM	36 mos	1/2021 - 12/2023									
D.2	G.O. BOND CAMPAIGN / ELECTION <i>(start after Master Plan approval)</i>	KH /C/ PM	14 mos	10/2021 - 11/2022				Election November 2022					
E.	LEGISLATIVE EXEMPTIONS/EXTENSION												
E.1	OSHPD DIALOGUE	KH/OSHPD	10 mos	3/2021 - 12/2021				KH had met with OSHPD Facilities Development Division on Feb 22, 2021					
E.2	SB 758 /LEGISLATIVE DIALOGUE / EXTENSION APPROVAL (7 to 10 years)	KH/CHA/CA	22 mos	32/2021 - 12/2022									
F.	FINANCING												
F.1	FUND TOWER PHASE 1 PRE-DESIGN PROGRAM MANAGEMENT	KH	4 mos	9/2021 - 12/2021									
F.2	DEVELOP TOWER PHASE 1 FINANCING <i>(estimate \$318 M - \$440 M)</i>	KH	4 mos	9/2021 - 12/2021									
F.3	PLANNING FOR G.O. BOND	KH	16 mos	9/2021 - 12/2022				Election November 2022					
F.4	PLANNING FOR REVENUE BOND, FUND-RAISING, OTHER FUNDING	KH	TBD										
F.5	FUND NPC-5 UPGRADES <i>(estimate \$40 million)</i>	KH	36 mos	1/2022 -12/2024									
F.6	FUND Mineral King Bldg SEISMIC & SPC-4D UPGRADE ANALYSIS <i>(If extension denied; estimate \$24 million)</i>	KH	14 mos	1/2022 -12/2024									
G.	OUTPATIENT FACILITIES PROGRAM												
	CREATE DEVELOPMENT PLAN FOR SEQUOIA GATEWAY LAND	KH	5 mos	9/2021 - 1/2022									
	SEQUOIA GATEWAY CONSTRUCTION	KH	36 mos	1/2023 - 12/2025									
	INDUSTRIAL PARK PRIMARY CARE CLINIC	KH	TBD										
	CALL CENTER	KH	TBD										
	TELEHEALTH PROGRAM	KH	TBD										
	RURAL HEALTH & FQHC CLINICS PROGRAM	KH	TBD										
	JOINT VENTURES & ACQUISITIONS	KH	TBD										
H.	IMPLEMENTATION PLANNING - Replacement Beds Phase 2 (120 beds)												
				2030									
				2021	2022	2023	2024	2025	2026	2027	2028	2029	2030

REPLACEMENT BEDS PHASE 1: 120 BEDS TOWER & PARKING STRUCTURE - IMPLEMENTATION SCHEDULE

		DUR.	DATES	2021	2022	2023	2024	2025	2026	2027	2028	2029	2030
1. SELECT FINAL OPTION													
1.1	DEVELOP MASTER PLAN OPTIONS	RBB/KH	4 MOS	completed									
1.2	BOARD APPROVAL OF TOWER-PARKING MASTER PLAN	KH	2 MOS	9/2021 - 10/2021									
1.3	COMPLETE FINAL MASTER PLAN & BUDGET COST ESTIMATE	KH/RBB	4 MOS	11/2021 - 2/2022									
1.4	BOARD ACCEPTANCE & APPROVAL OF PROJECT BUDGET	KH	1 MOS	2/2022									
G.O. BOND CAMPAIGN AND ELECTION		14 MOS	10/2021 - 11/2022										
2. ENTITLEMENTS													
2.1	ENVIRONMENTAL IMPACT REPORT	KH/PM	24 MOS	01/2023 - 12/2024									
2.2	ENTITLEMENTS NEGOTIATION	KH/PM	24 MOS	01/2023 - 12/2024									
3.0 PROGRAMMING, BRIDGING DOCUMENTS (TOWER & PARKING)		19 MOS											
3.1	SELECT PROJECT DELIVERY METHOD & PROGRAM MANAGER (PM)	KH	4 MOS	02/2022 - 04/2022									
3.2	PROGRAMMING	KH/PM	3 MOS	05/2022 - 07/2022									
3.3	PREPARE RFP FOR DESIGN-BUILD BRIDGING PACKAGES	KH/PM	3 MOS	05/2022 - 07/2022									
3.4	ISSUE RFP FOR BRIDGING PACKAGE ARCHITECT-ENGR	KH/PM	4 MOS	08/2022 - 11/2022									
3.5	AWARD DESIGN-BUILD BRIDGING CONTRACT	KH/PM	1 MOS	12/2022 - 12/2022									
3.6	PREPARE DESIGN-BUILD BRIDGING PACKAGES (after G.O. Bond)	KH/PM/A-E	6 MOS	01/2023 - 06/2023									
3.7	COMPLETE/APPROVE DESIGN-BUILD BRIDGING PACKAGES	KH/PM/A-E	1 MOS	07/2023 - 07/2023									
4.0 DESIGN-BUILD CONTRACTS PROCUREMENT (TOWER & PARKING)		13 MOS											
4.1	PREPARE RFQ FOR DESIGN-BUILD CONTRACTORS		2 MOS	07/2023 - 08/2023									
4.2	ISSUE RFQ & SHORTLIST DESIGN-BUILD CONTRACTORS	KH/PM/A-E	3 MOS	09/2023 - 11/2023									
4.3	BID DESIGN-BUILD CONTRACTS	KH/PM/A-E	6 MOS	12/2023 - 05/2024									
4.4	AWARD DESIGN-BUILD CONTRACTS	KH/PM/A-E	2 MOS	06/2024 - 07/2024									
5.0 CONSTRUCTION DOCUMENTS AND PLAN REVIEW (TOWER)		38 MOS											
5.1	PROJECT PLANNING /PROJECT SCOPE VALIDATION	KH/PM/DB	2 MOS	08/2024 - 09/2024									
5.2	SCHEMATIC/ DESIGN DEVELOPMENT	KH/PM/DB	6 MOS	10/2024 - 03/2025									
5.3	INCREMENT #1 - Make Ready & Demolition	KH/PM/DB	6 MOS	04/2025 - 09/2025									
5.4	INCREMENT #2 - Excavation & Shoring	KH/PM/DB	6 MOS	06/2025 - 11/2025									
5.5	INCREMENT #3 - Foundations & Superstructure	KH/PM/DB	8 MOS	06/2025 - 01/2026									
5.6	INCREMENT #4 - Enclosure & Interior Build-out	KH/PM/DB	12 MOS	08/2025 - 07/2026									
5.7	INCREMENT #5 - Site Improvements	KH/PM/DB	6 MOS	12/2025 - 05/2026									
5.8	OSHPD REVIEW & APPROVAL INCREMENT #1	OSHPD/DB	10 MOS	10/2025 - 07/2026									
5.9	OSHPD REVIEW & APPROVAL INCREMENT #2	OSHPD/DB	10 MOS	10/2025 - 09/2026									
5.10	OSHPD REVIEW & APPROVAL INCREMENT #3	OSHPD/DB	12 MOS	02/2026 - 01/2027									
5.11	OSHPD REVIEW & APPROVAL INCREMENT #4	OSHPD/DB	14 MOS	08/2026 - 09/2027									
5.12	OSHPD REVIEW & APPROVAL INCREMENT #5	OSHPD/DB	10 MOS	10/2026 - 07/2027									
6.0 MAKE-READY & CONSTRUCTION (TOWER)		38 MOS											
6.1	MAKE-READY & DEMOLITION	DB/PM/KH	6 MOS	08/2026 - 01/2027									
6.2	EXCAVATION & FOUNDATIONS	DB/PM/KH	6 MOS	02/2027 - 07/2027									
6.3	SUPERSTRUCTURE	DB/PM/KH	6 MOS	08/2027 - 01/2028									
6.4	EXTERIOR ENCLOSURE	DB/PM/KH	10 MOS	10/2027 - 07/2028									
6.5	MEP & INTERIOR BUILD-OUT	DB/PM/KH	16 MOS	04/2028 - 07/2029									
6.6	MEDICAL EQUIPMENT INSTALLATION	DB/PM/KH	4 MOS	04/2029 - 07/2029									
6.7	HARDSCAPE & LANDSCAPE	DB/PM/KH	6 MOS	07/2028 - 12/2028									
6.8	OSHPD FINAL AUDIT / COMMISSIONING	DB/OSHPD	4 MOS	06/2029 - 09/2029									
6.9	TOWER CERTIFICATE OF OCCUPANCY	OSHPD		09/2029									
7.0 CLOSE-OUT, STOCK & LICENSING, OPEN		5 MOS											
7.1	PROJECT CLOSE-OUT	DB/PM/KH	4 MOS	08/2029 - 11/2029									
7.2	STAFF & STOCK	KH/PM	4 MOS	08/2029 - 10/2029									
7.3	LICENSING	CDPH	2 MOS	11/2029 - 12/2029									
7.4	PATIENT-READY	KH/PM		12/2029									
7.5	TOWER PH1 OPEN	KH/PM		1/2030									
7.00 PARKING STRUCTURE (Design-Build)		30 MOS											
7.01	CONSTRUCTION DOCUMENTS	DB/PM/KH	6 MOS	01/2023 - 06/2023									
7.02	CITY REVIEW & APPROVAL	CITY	8 MOS	07/2023 - 02/2024									
7.03	CONSTRUCTION	DB/PM/KH	15 MOS	03/2024 - 05/2025									
7.04	PARKING CERTIFICATE OF OCCUPANCY	CITY		06/2025									
				2021	2022	2023	2024	2025	2026	2027	2028	2029	2030

Project Funding

Debt capacity and alternatives



[kawahhealth.org](https://www.kawahhealth.org)



July 2021 Update

- The information that was previously presented as attached has been updated to include the draft financial results as of June 30, 2021.

Project Funding Options

- Total Project costs are funded from one or more of the following sources of funds:
 - Excess cash reserves available from Kaweah Health
 - Community donations from a capital campaign
 - Revenue Bonds secured by a revenue fund pledge
 - Municipal Leases secured by equipment
 - One of the following tax supported obligations:
 - GO Bonds secured by ad valorem taxes
 - Revenue Bonds or COPs secured by parcel taxes
 - Revenue Bonds secured by sales taxes

Kaweah Health Current Debt

June 30, 2021:

- \$218.5 million of outstanding Revenue Bonds
- \$ 40.7 million of outstanding GO Bonds
- \$ 259.2 million of total debt outstanding

- \$ 16.9 million Maximum Annual Debt Service
- Current A3 “Negative” credit rating by Moody’s (March 2020)

Revenue Bonds

- Requires four-fifths vote of District Board of Directors
- Generally finance bricks & mortar and equipment
- Secured by a Gross Revenue Fund pledge
- Generally issued with 30 to 40-year maturity
- Limitation: H&SC Section 32316 for Revenue Bonds (debt obligations maturing in more than 10 years) equal to 50% of the KDHCDC's three-year average total revenues
- Limitation: Section 6.05 9a)(iii) of the Revenue Bond Indenture – Two-year average – pro forma minimum ratio of 1.5 times

Kaweah Health – Revenue Bonds
Limitation on Indebtedness (Health & Safety Code)
(000's Omitted)

	Fiscal Year Ended June 30			Average
	2019	2020	Est 2021	
Total Operating Revenue	\$ 751,573	\$ 734,348	\$ 774,694	\$ 742,961
Total Nonoperating Revenue	15,422	35,051	41,558	25,237
Total Revenues	<u>\$ 766,995</u>	<u>\$ 769,399</u>	<u>\$ 816,252</u>	<u>\$ 768,197</u>
Health & Safety Code Factor		<u>85%</u>		<u>50%</u>
Allowable as Promissory Notes (Sec. 32130.2)			<u>\$ 653,989</u>	
Allowable as Revenue Bonds (Sec. 32316)				<u>\$ 384,099</u>
		Promissory Notes	Revenue Bonds	Total
		(1-10 years)	(11-30 years)	
Existing Debt (as of 6/30/21):				
Capital Leases and Notes		\$ 47	\$ -	\$ 47
2012 Revenue Bonds		3,950	0	3,950
2015A Revenue Bonds		13,684	0	13,684
2015B Revenue Bonds		1,500	96,925	98,425
2017A&B Revenue Bonds		31,351	0	31,351
2017C Revenue Bonds		46,141	10,786	56,927
2020A&B Revenue Bonds		<u>9,630</u>	<u>4,525</u>	<u>14,155</u>
Total Existing Debt		<u>\$ 106,303</u>	<u>\$ 112,236</u>	<u>\$ 218,539</u>
Allowable Total Debt Capacity (see above)		\$ 653,989	\$ 384,099	
Total Revenue Based Existing Debt		<u>\$ 106,303</u>	<u>\$ 112,236</u>	<u>\$ 218,539</u>
Additional Revenue Based Debt Capacity		<u>\$ 547,686</u>	<u>\$ 271,863</u>	

Kaweah Health – Revenue Bonds
Limitation on Indebtedness (Section 6.05 (a)(ii) of the Indenture)
(000's Omitted)

	FYE June 30			FYE June 30		
	2019	2020	Average	2020	Est 2021	Average
Income Available to Meet Debt Service:						
Income Before Capital Contributions	\$27,908	(\$7,651)	\$10,129	(\$7,651)	\$10,717	\$1,533
Add Depreciation & Amortization	30,851	30,678	30,765	30,678	31,646	31,162
Add Interest Expense	7,208	7,411	7,310	7,411	8,408	7,910
Less Tax Revenues Relating to the GO Bonds	<u>(3,244)</u>	<u>(3,330)</u>	<u>(3,287)</u>	<u>(3,330)</u>	<u>(3,430)</u>	<u>(3,380)</u>
Income Available to Meet Debt Service	<u>\$62,723</u>	<u>\$27,108</u>	<u>\$44,916</u>	<u>\$27,108</u>	<u>\$47,341</u>	<u>\$37,225</u>
Maximum Annual Debt Service (no new debt)			<u>\$16,912</u>			<u>\$16,912</u>
Long-Term Debt Service Coverage Ratio			<u>2.66x</u>			<u>2.20x</u>
Maximum Annual Debt Service (\$100M new debt)			<u>\$21,737</u>			<u>\$21,737</u>
Long-Term Debt Service Coverage Ratio			<u>2.07x</u>			<u>1.71x</u>
Maximum Annual Debt Service (\$125M new debt)			<u>\$22,944</u>			<u>\$22,944</u>
Long-Term Debt Service Coverage Ratio			<u>1.96x</u>			<u>1.62x</u>
Maximum Annual Debt Service (\$150M new debt)			<u>\$24,150</u>			<u>\$24,150</u>
Long-Term Debt Service Coverage Ratio			<u>1.86x</u>			<u>1.54x</u>
Minimum Ratio Required			1.50x			1.50x

General Obligation Bonds

- Requires super majority resident vote (66.7%)
- Can only fund bricks & mortar (no equipment)
- Secured by special ad valorem property taxes
- Generally issued with a 30-year maturity
- Vote authorizes a specific borrowing amount or not-to-exceed GO Bond debt issuance limit
- Tax rate is based on the assessed value of taxable property, is set annually and is equal to the GO Bond debt service
- Ad valorem tax lasts only as long as the GO Bond debt is outstanding and then the tax goes away entirely

General Obligation Bonds

- Ballot measure must report three specific estimated tax rates:
 - First year tax rate
 - Highest year's tax rate
 - Average tax rate over term of GO Bonds
- Tax rate estimate requires assumptions of future assessed values and future interest rates
- Can be issued in tranches to meet timing of project costs to minimize early tax rates paid
- Limitation: H&SC Section 32300 for GO Bonds equal to 2.5% of assessed valuation (AV)

Kaweah Health – AV Growth rates and Health and Safety Code limitation

Fiscal Year	Unsecured	Unitary	Secured	Total	Growth % Change
Historical:					
2012-13	656,790,663	\$ 845,928,620	9,270,279,429	10,772,998,712	5.99%
2013-14	625,014,990	893,490,614	9,701,133,009	11,219,638,613	4.15%
2014-15	673,622,366	885,379,001	10,284,864,274	11,843,865,641	5.56%
2015-16	673,936,373	969,837,105	10,876,110,225	12,519,883,703	5.71%
2016-17	687,390,076	1,112,890,414	11,444,608,961	13,244,889,451	5.79%
2017-18	732,167,366	1,128,729,674	11,938,138,749	13,799,035,789	4.18%
2018-19	779,674,749	1,128,729,674	12,643,452,281	14,551,856,704	5.46%
2019-20	804,805,447	1,261,308,002	13,331,804,005	15,397,917,454	5.81%
2020-21	840,655,587	1,501,619,754	14,090,585,891	16,432,861,232	6.72%
Compounded Average Annual Growth Rate					<u>6.19%</u>

Projected:		Total Debt Limit	Debt Limit %	Outstanding 2014 Bonds	Additional Debt Capacity
2021-22	Projected Assessed Value at 4.00% Annual Growth	\$ 17,090,175,681	2.50%	\$ 427,254,392	\$ (38,951,000) \$ 388,303,392
2022-23	Projected Assessed Value at 4.00% Annual Growth	17,773,782,709	2.50%	444,344,568	(37,038,000) 407,306,568
2023-24	Projected Assessed Value at 4.00% Annual Growth	18,484,734,017	2.50%	462,118,350	(34,984,000) 427,134,350
2024-25	Projected Assessed Value at 4.00% Annual Growth	19,224,123,378	2.50%	480,603,084	(32,773,000) 447,830,084
2025-26	Projected Assessed Value at 4.00% Annual Growth	19,993,088,313	2.50%	499,827,208	(30,393,000) 469,434,208
2026-27	Projected Assessed Value at 4.00% Annual Growth	20,792,811,845	2.50%	519,820,296	(27,843,000) 491,977,296

Live with passion.

Health is our passion. Excellence is our focus. Compassion is our promise.



Kaweah Health

Focus Groups

- Report on Results -

June 2021



Market and Opinion Research

Probolsky Research
100 Pine Street Suite 1250
San Francisco CA 94111

San Francisco (415) 870-8150
Newport Beach (949) 855-6400
Washington DC (202) 559-0270

Table of Contents

QUALITATIVE REPORT	1
INTRODUCTION & METHOD	1
EMERGING THEMES AND RECOMMENDATIONS	4
SUMMARY OF THE RESULTS	8
APPENDIX A: DISCUSSION GUIDE	49
APPENDIX B: TRANSCRIPT	62
<u>GROUP 1</u>	62
<u>GROUP 2</u>	105
<u>GROUP 3</u>	154
<u>GROUP 4</u>	197
<u>GROUP 5</u>	245

Qualitative Report

Introduction & Method

Probolsky Research conducted five focus groups among Kaweah Delta Health Care District voters. The groups were each moderated by Adam Probolsky and focused on knowledge of Kaweah Delta and forward-looking thoughts on the District and a future bond measure.

Online Focus Group 1: Kaweah Delta Customers

Date: May 6, 2021

Video: [Group 1 Video](#)

Participants: There was a total of 11 participants:

Party Legend	
NPP	No Party Preference
Dem.	Democrat
GOP	Republican
Am. Indep.	American Independent

Name	Age	Party	City	Home	Group
[REDACTED]	65+	[REDACTED]	Visalia	Own	Group 1
[REDACTED]	65+	[REDACTED]	Visalia	Own	Group 1
[REDACTED]	30-39	[REDACTED]	Visalia	Own	Group 1
[REDACTED]	65+	[REDACTED]	Visalia	Own	Group 1
[REDACTED]	30-39	[REDACTED]	Visalia	Own	Group 1
[REDACTED]	18-29	[REDACTED]	Visalia	Neither	Group 1
[REDACTED]	30-39	[REDACTED]	Visalia	Own	Group 1
[REDACTED]	18-29	[REDACTED]	Farmersville	Neither	Group 1
[REDACTED]	18-29	[REDACTED]	Visalia	Rent	Group 1
[REDACTED]	30-39	[REDACTED]	Visalia	Own	Group 1
[REDACTED]	30-39	[REDACTED]	Visalia	Rent	Group 1

Online Focus Group 2: Kaweah Delta Customers

Date: May 11, 2021

Video: [Group 2 Video](#)

Participants: There was a total of 11 participants:



Probolsky Research
100 Pine Street Suite 1250
San Francisco CA 94111

San Francisco (415) 870-8150
Newport Beach (949) 855-6400
Washington DC (202) 559-0270

Name	Age	Party	City	Home	Group
████	50-64	████	Visalia	Own	Group 2
████	40-49	████	Visalia	Own	Group 2
████	18-29	████	Visalia	Own	Group 2
████	65+	████	Visalia	Own	Group 2
████	30-39	████	Visalia	Own	Group 2
████	65+	████	Visalia	Neither	Group 2
████	40-49	████	Visalia	Own	Group 2
████	18-29	████	Visalia	Rent	Group 2
████	30-39	████	Visalia	Rent	Group 2
████	40-49	████	Ivanhoe	Own	Group 2
████	65+	████	Visalia	Own	Group 2

Online Focus Group 3: Kaweah Delta Customers

Date: May 13, 2021

Video: [Group 3 Video](#)

Participants: There was a total of 14 participants:

Name	Age	Party	City	Home	Group
████	40-49	████	Visalia	Rent	Group 3
████	30-39	████	Visalia	Rent	Group 3
████	18-29	████	Visalia	Rent	Group 3
████	30-39	████	Visalia	Own	Group 3
████	50-64	████	Visalia	Own	Group 3
████	18-29	████	Visalia	Neither	Group 3
████	40-49	████	Visalia	Rent	Group 3
████	40-49	████	Visalia	Own	Group 3
████	30-39	████	Visalia	Own	Group 3
████	30-39	████	Visalia	Own	Group 3
████	18-29	████	Visalia	Neither	Group 3
████	50-64	████	Visalia	Own	Group 3
████	65+	████	Visalia	Own	Group 3
████	50-64	████	Visalia	Rent	Group 3

Online Focus Group 4: Kaweah Delta Customers

Date: June 3, 2021

Video: [Group 4 Video](#)



Probolsky Research
100 Pine Street Suite 1250
San Francisco CA 94111

San Francisco (415) 870-8150
Newport Beach (949) 855-6400
Washington DC (202) 559-0270

Participants: There was a total of 9 participants:

Name	Age	Party	City	Home	Group
██████	50-64	██████	Visalia	Own	Group 4
██████	50-64	██████	Visalia	Own	Group 4
██████	40-49	██████	Visalia	Rent	Group 4
██████	40-49	██████	Visalia	Own	Group 4
██████	30-39	██████	Visalia	Own	Group 4
██████	40-49	██████	Visalia	Rent	Group 4
██████	30-39	██████	Visalia	Own	Group 4
██████	18-29	██████	Visalia	Neither	Group 4
██████	40-49	██████	Visalia	Own	Group 4

Online Focus Group 5: Kaweah Delta Customers

Date: June 7, 2021

Video: [Group 5 Video](#)

Participants: There was a total of 10 participants:

Name	Age	Party	City	Home	Group
██████	50-64	██████	Visalia	Other	Group 5
██████	50-64	██████	Visalia	Own	Group 5
██████	40-49	██████	Visalia	Own	Group 5
██████	65+	██████	Visalia	Own	Group 5
██████	65+	██████	Visalia	Rent	Group 5
██████	50-64	██████	Visalia	Own	Group 5
██████	40-49	██████	Visalia	Rent	Group 5
██████	50-64	██████	Visalia	Own	Group 5
██████	50-64	██████	Visalia	Own	Group 5
██████	30-39	██████	Visalia	Own	Group 5

This report highlights key commentary from the discussions, with our goal of delivering actionable information. You will also likely find reviewing the transcript to be helpful towards developing a rich, unique understanding of the vernacular and tone of participants.

It is important to note that while the results of the focus group are not statistically significant, they do help us uncover common language, themes, and messages to test further.

We have provided both the discussion guide and transcripts for each focus group session as an appendix.



Probolsky Research
100 Pine Street Suite 1250
San Francisco CA 94111

San Francisco (415) 870-8150
Newport Beach (949) 855-6400
Washington DC (202) 559-0270

This discussions took place online via the Zoom video conferencing platform and participants all engaged in a robust conversation.

Emerging Themes and Recommendations

Residents identify Kaweah Delta from their past experiences as patients, with the most common interaction the birth of a child. Residents are aware of Kaweah Delta’s multiple clinics in the surrounding community, its helipad, Level III trauma center and cardiac surgery department. Residents identify Kaweah Delta as “one of the only hospitals in our area” that meets a high “standard” of care and is rapidly expanding. Some residents are aware that Kaweah Delta recently changed its name and is rebranding.

Based on their experiences, residents are pleased with “excellent” nursing care, “very helpful, very nice” staff, “amazing” urgent care, quick results, and consistent “follow up”. Residents say that they like Kaweah Delta’s individual patient rooms, additional space with an expanded facility, community outreach and economic support.

Residents offer negative feedback about Kaweah Delta, but express concerns about the monopoly on care and “elitist” leadership. Respondents mentioned their “negative experiences in the ER,” claiming that they were “forgotten about in the waiting room.” Some respondents say that they experienced “a lot of miscommunication with the doctors”.

GROUP 1: Residents in Group 1 expressed a high level of awareness of Kaweah Delta’s major services and organizational structure, with residents most surprised that the District is managed by just a five-member board.

Many residents are surprised to learn that Kaweah Delta offers a Level III Trauma Center. Many residents are impressed with the size of hospital and the range of medical services including general surgery, cancer treatment, cardiac surgery and neurosurgery. Residents are surprised to learn the level of economic development and number of jobs created by Kaweah Delta.

Residents are aware that “a lot of people from Farmersville and Tulare go to Kaweah Delta” but are surprised to learn that those who live outside the Kaweah Delta’s jurisdictional boundaries do not contribute to the District’s tax base. Residents say that no one should be turned away, but express support for “expanding” the District’s jurisdictional areas to make other areas “pay the taxes on the hospital,” especially those patients that “are going consistently” to Kaweah Delta’s facilities.



Probolsky Research
100 Pine Street Suite 1250
San Francisco CA 94111

San Francisco (415) 870-8150
Newport Beach (949) 855-6400
Washington DC (202) 559-0270

Residents say that they generally trust Kaweah Delta, with respondents explicitly stating their affirmative support, or saying that the “have no reason not to.” Other say that they have mixed opinions based on rumors from former employees who they know. A small number of residents express general skepticism and distrust for large institutions in general, with other residents expressing mixed opinions based on a past negative experience.

A large number of residents say that they would trust a nurse or employee, who would be “more blunt”, “won’t be political” and would share “the real truth” about Kaweah Delta. Several respondents say that they would trust the executive leadership, including the Board of Directors or CEO. A small number of residents say that they would trust a combination of personnel, including a doctor, depending on “what kind of information you're looking for.” The Board of Directors are seen as being connected to the community and even in the face of probing, seem to enjoy broad trust from voters.

Residents overwhelmingly see Kaweah Delta “as a small-town hospital you go to because its close”. Although in the minority, residents that see Kaweah Delta as “a hospital you choose to go to for complex care” offer more intense and passionate responses that “you can do a lot” and are “satisfied over 100% with the cardiac treatment.”

Most residents are generally unaware of Kaweah Delta’s affiliation with the Cleveland Clinic, but nearly all are impressed by the designation.

Residents overwhelmingly say that financial and medical resources are essential to attracting top staff to “keep the good doctors here” in order to provide high-quality care “in a more rural community”. Residents connect adequate financial and medical resources with their status as a rural community because in an emergency situation “you might not have that luxury of time to be able to travel to some of these other centers.” Residents say that financial resources are needed to have “the right medical supplies”, “keep up on the latest technology”, and ensure that the hospital is “sustainable”.

Most residents do not identify a specific need, but instead say that Kaweah Delta has “done a lot of improvements” and has been “redoing, revamping the emergency room.” The parking needs to be improved according to many participants.

Residents overwhelmingly support modernization including replacing the Mineral King wing of Kaweah Delta as essential – with nearly unanimous support in multiple groups because it is something that “we have to do”.

Residents see the new wing as linked to the need for more bed space as the community is growing. Residents view modernization in terms of technology, citing “newer equipment,”



Probolsky Research
100 Pine Street Suite 1250
San Francisco CA 94111

San Francisco (415) 870-8150
Newport Beach (949) 855-6400
Washington DC (202) 559-0270

“newer technology, medical supplies, equipment,” and “state-of-the-art therapies”. Several residents view modernization in terms of facilities that are earthquake retrofitted, have “structural modifications,” “adding facilities” ... “that can take care of all my medical needs.” Residents say that modernizing means “better facilities and better staff” who are “trained on the newest technologies and systems”.

Most residents have limited or no knowledge of the 2016 Measure H general obligation bond measure. Of residents that remember Measure H, they say that the measure failed because “people just don't want their taxes raised” to fund a bond for “a lot of money” without detailing “what their plan was to do with it” and the issue over non-District users getting the benefit without paying the tax.

Residents overwhelmingly agree that the District should explore every source of funding but are “cautious about the idea of them taking out loans” and “asking community for more than you're probably going to contribute”. Residents generally believe that anyone should have access to the hospital, even if they do not pay for care. Some residents say it would be better if Kaweah Delta “expanded the amount of taxpayers.”

Some residents say that the District has done “a good job with transparency” – with several saying that they have “seen the commitment” through a “a big push for education” and outreach “especially with social media...after COVID hit.” Others says that the District’s outreach is “poor” and “can definitely improve.”

Residents express support for knowing that the District “hired RBB because of their track record of building lower cost hospitals, they're highly efficient.” A small number of residents express skepticism about how the designer and architectural group were selected.

Patients agree that the current “pie-shaped” rooms are cramped and offer a poor patient experience, especially when additional equipment is brought into the room. Residents overwhelmingly prefer the “ideal patient” room, which “allows for family members to stay”. Residents agree that newer, “Acequia Wing” patient rooms are much bigger, safer and have better space for medical equipment.

Residents generally prefer the “cheaper” Option 2, citing less congestion and the elimination of elevator waiting time and congestion. Of residents that prefer Option 1, they cite the “phase approach” because it leaves more room for error and corrections. Residents say that the bond measure will provide the community with medical services that are needed.



Probolsky Research
100 Pine Street Suite 1250
San Francisco CA 94111

San Francisco (415) 870-8150
Newport Beach (949) 855-6400
Washington DC (202) 559-0270

Residents overwhelmingly say that they would support a bond measure. Of residents opposed to the bond measure, they say that they already pay enough in taxes. Residents say that they would like to see action on a bond measure sooner rather than later.

Option 1: Residents overwhelmingly express support for the bond measure when told that the approximate cost is \$142 per year for a homeowner with a \$400,000 home. Some residents say that they would “need more information” and for the District “to sell me” and “give me a vision of something.”

Residents express less support for Option 2 but are generally open to it. Some residents are skeptical about the property tax estimates, saying that “it always goes for the highest amount” and that “the homeowner gets hit with everything.”

In explaining the issue to their friends or neighbors, residents would first describe “an actual need” for facility improvements, especially earthquake retrofitting, then would explain that a bond measure would pay for it. A small number would reference the impact on local jobs and the economy.

Residents support issuing a bond – while maintaining reserves in the bank— in order to prepare for the unexpected. In Group 1, several residents expressed confusion over Kaweah Delta’s status as a for-profit or non-profit hospital – with the preferred description as “a public hospital”.

Residents generally support the idea of expanding the map and consolidating with other “more impoverished areas,” especially if those communities are “going to be using the services.” Residents are generally unpersuaded by the connection between offering services to those living outside the area and its relationship to additional medical service offerings.



Probolsky Research
100 Pine Street Suite 1250
San Francisco CA 94111

San Francisco (415) 870-8150
Newport Beach (949) 855-6400
Washington DC (202) 559-0270

Summary of the Results

Quotations from focus group participants appear below as indented text. Three periods within quotations signify omitted text, words irrelevant to the message, but under no circumstances are words omitted in a manner that might change the participant's meaning. In a few instances, words within a quotation appear in brackets. These words are added for clarity and to facilitate interpretation of the participant's meaning.

What do you know of Kaweah Delta?

Residents identify Kaweah Delta from their past experiences as patients, with the most common interaction the birth of a child.

- “My daughter was born there.” – [REDACTED] (65+, [REDACTED], Visalia, Own, Group 1)
- “My son was born there and my daughter was born there...” – [REDACTED] (30-39, [REDACTED] Visalia, Own, Group 2)
- “I was born there and it's one of the biggest hospitals serving in Tulare County.” – [REDACTED] (18-29, [REDACTED], Visalia, Neither, Group 1)
- “Well, I had open heart surgery there once. And I've had probably several other surgeries. And when I was with the newspaper spent a lot of time covering it.” – [REDACTED] (65+, [REDACTED], Visalia, Own, Group 1)
- “Both my husband and I have been there to the ER...” – [REDACTED] (50-64, [REDACTED] Visalia, Own, Group 4)
- “...I've been a patient there many times...” – [REDACTED] (50-64, [REDACTED], Visalia, Own, Group 5)
- “...Gave birth to three of my children there...” – [REDACTED] (65+, [REDACTED], Visalia, Rent, Group 5)

Residents are aware of Kaweah Delta's multiple clinics in the surrounding, its helipad, Level III trauma center and cardiac surgery department.



Probolsky Research
100 Pine Street Suite 1250
San Francisco CA 94111

San Francisco (415) 870-8150
Newport Beach (949) 855-6400
Washington DC (202) 559-0270

- “...they have the main hospital. They also have many, if you want to call them satellite clinics. I know that they have clinics in Exeter, and I saw clinic in Tulare...” – [REDACTED] (18-29, [REDACTED], Visalia, Rent, Group 2)
- “...I know that they...had several different branches to serve several different needs... they have several different locations, even general practice doctors are a part of their network.” - [REDACTED] a (30-39, [REDACTED], Visalia, Own, Group 3)
- “They have a good heart area for heart surgery for people...” – [REDACTED] (40-49, [REDACTED], Visalia, Rent, Group 3)
- “...I take my kids to Visalia Medical Clinic, which I know is run through Kaweah Health...” – [REDACTED] (30-39, [REDACTED], Visalia, Own, Group 4)
- “I know Kaweah Delta is a level three trauma center. One thing that surprises me is that Kaweah Delta serves the entire Tulare County and that's a lot for such a small hospital...” – [REDACTED] (30-39, [REDACTED], Visalia, Own, Group 5)
- “There's a helipad.” – [REDACTED] (30-39, [REDACTED] Visalia, Own, Group 1)

Residents identify Kaweah Delta as “one of the only hospitals in our area” that meets a high “standard” of care and is rapidly expanding.

- “One of the only hospitals in our area.” – [REDACTED] (18-29, [REDACTED], Visalia, Rent, Group 1)
- “...I had my children both there. And growing up, I just remember when my mom was, she's diabetic. Immediately when she got sick, nope, let's not go to Tulare Hospital let's go Kaweah, because it always had that standard...” – [REDACTED] (30-39, [REDACTED], Visalia, Rent, Group 1)
- “I know the main Kaweah Delta hospital has been rapidly expanding the last couple of years with the feature of that new emergency room that they're about to finish up.” – [REDACTED] 18-29, [REDACTED], Visalia, Rent, Group 3)

Residents are aware that Kaweah Delta recently changed its name and is rebranding.



Probolsky Research
 100 Pine Street Suite 1250
 San Francisco CA 94111

San Francisco (415) 870-8150
 Newport Beach (949) 855-6400
 Washington DC (202) 559-0270

- “They just had a name, change, Kaweah Medical.” – ██████████ 65+, ██████████, Visalia, Own, Group 1)
- “I think it was Kaweah Health.” – ██████████ (30-39, ██████████, Visalia, Rent, Group 2)
- “...I know they just rebranded...” – ██████████ (30-39, ██████████, Visalia, Own, Group 3)

What do you like about Kaweah Delta?

Based on their experiences, residents are pleased with “excellent” nursing care, “very helpful, very nice” staff, “amazing” urgent care, quick results, and consistent “follow up”.

- “...I've had both of my boys born there, so as far as my experience with the baby ward, that was really great. They were very helpful, very nice people.” – ██████████ (30-39, ██████████, Visalia, Rent, Group 3)
- “... I've had not only myself but my husband and my mother have both received care there and the nursing care was excellent.” – ██████████ 65+, ██████████, Visalia, Own, Group 1)
- “...So their Urgent Cares are amazing and that's what I love since they started opening those up...” – ██████████ (50-64, ██████████, Visalia, Own, Group 4)
- “I like how they do the follow up...I like how they send that follow-up to see how your visit went or what your opinion was of, if there was any improvements or anything needed” – ██████████ (40-49, ██████████, Ivanhoe, Own, Group 2)
- “...It seems that like whenever test results are needed, that test results do come back fairly quickly...” – ██████████ (18-29, ██████████, Visalia, Rent, Group 2)

Residents say that they like Kaweah Delta’s individual patient rooms, additional space with an expanded facility, community outreach and economic support.

- “... I believe all of the rooms are individual, actually.” – ██████████ (30-39, ██████████, Visalia, Own, Group 1)
- “Yes, it's nice to have a single room when it's, when you have a loved one there or being there yourself. It's nice.” – ██████████ (65+, ██████████, Visalia, Own, Group 1)



Probolsky Research
100 Pine Street Suite 1250
San Francisco CA 94111

San Francisco (415) 870-8150
Newport Beach (949) 855-6400
Washington DC (202) 559-0270

- "...they've been expanding a lot and a new building and moving the delivery rooms and stuff into the newer building. So it's nice to have more space." – [REDACTED] (18-29, [REDACTED], Visalia, Neither, Group 1)
- "I like the concept of Visalia Medical Clinic... Where it's kind of an all in one where you can go see your doctor..." – [REDACTED] (40-49, [REDACTED], Visalia, Own, Group 2)
- "I like how they try to reach out to the community..." – [REDACTED] (40-49, [REDACTED], Visalia, Own, Group 2)
- "That hospital basically almost supports the entire downtown..." – [REDACTED] (40-49, [REDACTED], Visalia, Own, Group 4)
- "They're a sponsoring institution for medical education and residency programs." – [REDACTED] (50-64, [REDACTED], Visalia, Own, Group 3)

What don't you like about Kaweah Delta?

Residents offer minimal negative feedback about Kaweah Delta, but express concerns about the monopoly on care and "elitist" leadership. Respondents mentioned their "negative experiences in the ER," claiming that they were "forgotten about in the waiting room." Some respondents say that they experienced "a lot of miscommunication with the doctors".

- "...nothing too bad, fairly well, but it seems very monopolized in that seem like they control the whole county... it's just Kaweah Delta for the most part ... But you can't say too many bad things about them, but that was a little weird." – [REDACTED] (30-39, [REDACTED], Visalia, Own, Group 1)
- "...I do know that the board, the higher up people can be somewhat elitist as well as to move up within there, you kind of need to know them and be on their good side. I only know this because my mom's a nurse and my aunt actually had a private practice [REDACTED] [REDACTED].." – [REDACTED] (18-29, [REDACTED], Visalia, Rent, Group 1)
- "...it was an ER visit, but I'm pretty sure we were forgotten about in the waiting room or after we were helped for a couple of hours and I had to like track someone down..." – [REDACTED] (50-64, [REDACTED], Visalia, Own, Group 2)



Probolsky Research
100 Pine Street Suite 1250
San Francisco CA 94111

San Francisco (415) 870-8150
Newport Beach (949) 855-6400
Washington DC (202) 559-0270

- “...I did have an experience at Kaweah Delta that was very negative in the ER department where I was going through a miscarriage and I was bleeding out and it took quite a bit to get medical attention...” – ██████ (18-29, ██████, Visalia, Rent, Group 2)
- “...My husband was once admitted and we had, not the best experience with communication from some doctors...” – ██████ (30-39, ██████, Visalia, Own, Group 3)
- “...They had a doctor tell us that it was something else that was genetic, and so it kind of put our family into a frenzy for a few days only to find out that it wasn't the case. Just a lot of miscommunication with the doctors...” – ██████ (18-29, ██████, Visalia, Neither, Group 3)

Kaweah Delta was founded in 1961 as a type of local government agency called a hospital district. Now it is the largest hospital in Tulare County and a certified level III Trauma Center. More than 5,100 employees work for Kaweah Delta plus 600 medical staff are affiliated with the hospital. With eight-campuses the hospital has over 613 beds and is the only local hospital in Visalia. Kaweah Delta offers comprehensive health services including cardiac surgery, general surgery, neurosurgery, cancer treatment, mental health services, orthopedic surgery, a renowned NICU and pediatric center, and other treatments.

The formal name for the government agency that governs the hospital is Kaweah Delta Health Care District and it is overseen by a five-member board of directors that is elected by the voters that live in the district.

Who knew this? What do you think about a hospital being owned by the taxpayers?

Residents in Group 1 expressed a high level of awareness of Kaweah Delta’s major services and organizational structure, with residents most surprised that the District is managed by just a five-member board.

- “Not really. I don't know too much about administration, but the five member board of directors, I'm not sure that's normal for how big Kaweah Delta is or if there should be more. But other than that, everything else doesn't really stick out to me.” – ██████ (30-39, ██████, Visalia, Own, Group 1)



Probolsky Research
100 Pine Street Suite 1250
San Francisco CA 94111

San Francisco (415) 870-8150
Newport Beach (949) 855-6400
Washington DC (202) 559-0270

- "...there's not much there I didn't already know. I had a friend who had a baby that was in the NICU and they got just very, just excellent care ... I am kind of surprised that they only have a five member board of directors. I would think that the board of directors there would be more than five..." – ██████████ (65+, ██████████, Visalia, Own, Group 1)
- "I didn't know about the five member board of directors and how that, how they're elected here. I didn't know that. It does seem a little odd how there's five people in control of such a big hospital. ... five people in charge of making decisions out of this big hospital. That's kind of shocking and interesting." – ██████████ (18-29, ██████████, Visalia, Neither, Group 1)

Many residents are surprised to learn that Kaweah Delta offers a Level III Trauma Center.

- "I did not know it was a level three trauma center." – ██████████ (30-39, ██████████, Visalia, Own, Group 2)
- "The level three trauma center was what stood out to me..." – ██████████ (40-49, ██████████, Visalia, Own, Group 2)
- "The level three trauma center is interesting." – ██████████ (50-64, ██████████, Visalia, Rent, Group 3)

Many residents are impressed with the size of hospital and the range of medical services including general surgery, cancer treatment, cardiac surgery and neurology.

- "...I didn't realize how large and how extensive the hospital was..." – ██████████ (65+, ██████████, Visalia, Own, Group 5)
- "The percentage. Just the percentage of beds to the population of Tulare County..." – ██████████ (65+, ██████████, Visalia, Rent, Group 5)
- "I didn't realize it had that many beds. 613, it's a pretty large hospital." – ██████████ (30-39, ██████████, Visalia, Rent, Group 2)



Probolsky Research
100 Pine Street Suite 1250
San Francisco CA 94111

San Francisco (415) 870-8150
Newport Beach (949) 855-6400
Washington DC (202) 559-0270

- “The eight campuses was pretty surprising.” – [REDACTED] (40-49, [REDACTED], Ivanhoe, Own, Group 2)
- “The general surgery and neurology that is something that's important for this area. Had family members go through those areas and they were very satisfied with the Kaweah Delta.” – [REDACTED] (65+, [REDACTED], Visalia, Own, Group 2)
- “...the cardiac department is somehow connected with a larger cardiac department, a prestigious cardiac department somewhere else...” – [REDACTED] (40-49, [REDACTED], Visalia, Own, Group 2)
- “...I think both in neurosurgery and the cardiac, the affiliations with hospitals and, or systems that specialize in those areas really does benefit our communities... The Cleveland center the cardiac center that they interact with...” – [REDACTED] (65+, [REDACTED], Visalia, Own, Group 2)
- “The one thing that stood out for me was, that they had a renowned NICU which I didn't realize they had, that's pretty cool...” – [REDACTED] (40-49, [REDACTED], Visalia, Rent, Group 3)

Residents are surprised to learn the level of economic development and number of jobs created by Kaweah Delta.

- “Well, the 5,100 employees, if we have 150,000 people or so in Visalia, that's 3% of the population that works for Kaweah Delta. So it definitely plays a huge role probably in the whole county, the whole area of the economy, things like that” – [REDACTED] (18-29, [REDACTED], Visalia, Rent, Group 1)
- “I'll just go ahead and piggyback on a couple other people talking about a 5,100 jobs. That's a pretty incredible ... level of employment here, especially since this is the area is known for its low employment levels.” – [REDACTED] (30-39, [REDACTED], Visalia, Own, Group 1)
- “It's interesting that they have a 5100 employees, pretty impressive.” – [REDACTED] (50-64, [REDACTED], Visalia, Own, Group 3)
- “I didn't realize that it employed that many employees...” – [REDACTED] (30-39, [REDACTED], Visalia, Own, Group 4)



Probolsky Research
 100 Pine Street Suite 1250
 San Francisco CA 94111

San Francisco (415) 870-8150
 Newport Beach (949) 855-6400
 Washington DC (202) 559-0270

- “... I didn't realize there was that many employees there...” – [REDACTED] (40-49, [REDACTED], Visalia, Own, Group 5)

Voters who live within the boundaries of this map elect the Kaweah Delta Health Care District board members and pay taxes to the Health Care District, but anyone can be a patient at the hospital regardless of where they live.

What do you think about the map? What do you think about anyone being able to seek care at Kaweah Delta?

Residents are aware that “a lot of people from Farmersville and Tulare go to Kaweah Delta” but are surprised to learn that those who live outside the Kaweah Delta’s jurisdictional boundaries do not contribute.

- “... I thought a lot of people from Farmersville and Tulare go to Kaweah Delta because the next big hospital will be in Porterville or Hanford. And I think the city of Farmersville would commute to Visalia in order to go to the district or to Kaweah Delta.” – [REDACTED] (30-39, [REDACTED], Visalia, Own, Group 2)
- “Growing up, I always knew that my friends, Farmersville would come to the hospital here, that's why I find it kind of interesting that it's kind of not involved in this diagram...” – [REDACTED] (18-29, [REDACTED], Visalia, Own, Group 2)
- “...Tulare has the Kaweah Delta campus, if that's what's officially called a campus or a satellite building, but as well as Exeter. Exeter a pretty big Kaweah Delta Clinic over there as well. So that's interesting in that they don't contribute, however, there's the different campuses that are in those cities. Better satellites, both of Kaweah Delta.” – [REDACTED] (18-29, [REDACTED], Visalia, Rent, Group 2)
- “And the surrounding cities are like Three Rivers, Woodlake. I mean, it would seem like all those would contribute to the Kaweah Delta fund or somehow, because it seems like they're all coming into the city.” – [REDACTED] (30-39, [REDACTED], Visalia, Own, Group 2)

Residents say that no one should be turned away, but express support for “expanding” the hospital’s jurisdictional areas to make other areas “pay the taxes on the hospital,” especially those patients that “are going consistently” to Kaweah Delta’s facilities.



Probolsky Research
100 Pine Street Suite 1250
San Francisco CA 94111

San Francisco (415) 870-8150
Newport Beach (949) 855-6400
Washington DC (202) 559-0270

- “...Obviously we don't want to turn anybody away, but if we know that that's where people are going consistently for their healthcare, then it does make sense to have them contribute.” – ██████ (40-49, ██████, Visalia, Own, Group 2)
- “...I believe if you're in the surrounding area, where if there is something going on in your hospital, then they should be paying the taxes on the hospital that is in the nearest area.” – ██████ (18-29, ██████, Visalia, Rent, Group 2)
- “...I'm glad that we do serve multiple people, but it's just concerning why only by Visalia and Ivanhoe and Goshen are paying these taxes.” – ██████ (18-29, ██████, Visalia, Neither, Group 3)
- “I hold objection to that obviously because it's a very, very small district, but yet it serves a much greater community. So I would like to see it included and expanded to a much greater degree.” – ██████ (65+, ██████, Visalia, Own, Group 5)
- “...I don't have any qualms with anyone using medical resources outside the boundary, but at the same time, I do have the thought of, well, if the default hospital is this for say Tulare and Farmersville, it seems like it makes sense to have them within that boundary as far as contributing tax wise.” – ██████ (50-64, ██████, Visalia, Own, Group 2)

Do you trust Kaweah Delta? The medical care they provide, the leadership to tell the truth, to always consider the best interest of the community in how they operate?

Residents say that they generally trust Kaweah Delta, with respondents explicitly stating their affirmative support, or saying that the “have no reason not to.”

- “...I do. I think they do an excellent job...” – ██████ (65+, ██████, Visalia, Own, Group 1)
- “I generally trust them, yes.” – ██████ (65+, ██████, Visalia, Own, Group 1)
- “I trust the product there. I have no reason I say right now not trust the leadership but I haven't heard anything about it. Unless something changes...” – ██████ (18-29, ██████, Farmersville, Neither, Group 1)
- “You would have to, right?” – ██████ (30-39, ██████, Visalia, Own, Group 2)



Probolsky Research
100 Pine Street Suite 1250
San Francisco CA 94111

San Francisco (415) 870-8150
Newport Beach (949) 855-6400
Washington DC (202) 559-0270

- “I really don't have another choice.” – [REDACTED] (30-39, [REDACTED], Visalia, Rent, Group 2)
- “I don't have any reason not to. Other than when it comes to bureaucratic things, there's always going to be something messy involved...” – [REDACTED] (30-39, [REDACTED], Visalia, Own, Group 1) & [REDACTED] (30-39, [REDACTED], Visalia, Own, Group 1)
- “Yes.” – [REDACTED] (18-29, [REDACTED], Visalia, Rent, Group 2)

A small number of residents say that they have mixed opinions based on rumors from former employees who they know.

- “...I am kind of familiar with people (who work there) ... I have heard things about them not fully reporting statistics or how, if you have like a more serious condition you're not necessarily taken care of in the right way. So I think it's yes and no. Yes. I would go there, if I had food poisoning, but no, I would not go there for brain surgery.” – [REDACTED] (18-29, [REDACTED], Visalia, Rent, Group 1)

A small number of residents express general skepticism and distrust for large institutions in general, with other residents expressing mixed opinions based on a past negative experience.

- “For medical care I think I, yeah, I would trust them. I don't have any reason to. But generally for me, I personally just don't trust these really powerful institutions. I feel often gets really muddled. The truth can get muddled, but that's where I feel, that's where I stand.” – [REDACTED] (18-29, [REDACTED], Visalia, Neither, Group 1)
- “...I mean, if I'm going there for a minor injury, yes, I'll trust them. But if I need some specialty care, like I would say neurosurgery or cancer treatment, I'll definitely seek one of the bigger universities like UCSF or UCLA...” – [REDACTED] (30-39, [REDACTED], Visalia, Own, Group 5)
- “I've had some negative experiences, but this was like about 20 years ago when I had to go in there to stay there for a lengthy time for surgery. And there were some rude nurses sometimes...” – [REDACTED] (65+, [REDACTED], Visalia, Own, Group 2)
- “...So professionally and personally, we've had such a long history of negative experiences with them and how they've handled situations...” – [REDACTED] (40-49, [REDACTED], Visalia, Rent, Group 4)



Probolsky Research
100 Pine Street Suite 1250
San Francisco CA 94111

San Francisco (415) 870-8150
Newport Beach (949) 855-6400
Washington DC (202) 559-0270

- “...I had a bad experience when I took my wife...” – █████ (50-64, █████, Visalia, Own, Group 5)

Who would you trust the most to tell you about the future of the hospital, a doctor, a nurse, or hospital administrator/CEO, a health care district board member? Someone else? Why?

A large number of residents say that they would trust a nurse or employee, who would be “more blunt”, “won’t be political” and would share “the real truth” about Kaweah Delta.

- “Well, if I wanted information from a CEO, I would go to them for what needs to be changed. But then in regards to the real truth, I would probably speak to a nurse because they're going to tell you what's going on behind the curtain.” – █████ (30-39, █████, Visalia, Own, Group 1)
- “The nurse. They're the more blunt and won't be political, I guess.” – █████ (30-39, █████, Visalia, Rent, Group 1)
- “Probably definitely the nurse, because especially if the issues are lying within a hierarchal type of thing. I would feel I would get the most truthful answers from someone at the bottom.” – █████ (18-29, █████, Visalia, Rent, Group 1)
- “Possibly the staff, like lower staff, like nurses. I would trust their perspective on the future of the business, much more than somebody who is profiting more from it.” – █████ (40-49, █████, Visalia, Rent, Group 3)
- “... I would get the insight from the nurses and employees...” – █████ (50-64, █████, Visalia, Rent, Group 3)
- “I would definitely say the employees because it's the employees who choose to work there...” – █████ (18-29, █████, Visalia, Rent, Group 2)
- “...the people that are working on the line, and the staff...” – █████ (65+, █████, Visalia, Own, Group 2)
- “Well, I'd say employees, I've had a couple of run-ins with some of the employees at my previous job and whatever questions I've had for them, they've answered them...” – █████ (40-49, █████, Visalia, Own, Group 5)



Probolsky Research
100 Pine Street Suite 1250
San Francisco CA 94111

San Francisco (415) 870-8150
Newport Beach (949) 855-6400
Washington DC (202) 559-0270

Several respondents say that they would trust the executive leadership, including the Board of Directors or CEO.

- “I would trust CEO and board.” – [REDACTED] (50-64, [REDACTED], Visalia, Own, Group 3)
- “I like to think its employees, but it's probably the board of directors.” – [REDACTED] (30-39, [REDACTED], Visalia, Rent, Group 2)
- “I would probably say a board member. I don't believe that a CEO would really put a lot of information out there because they usually have the spokesperson to do that...” – [REDACTED] (40-49, [REDACTED], Ivanhoe, Own, Group 2)
- “I would definitely say that a board member would be a good start for knowing about the future of the hospital itself...” – [REDACTED] (30-39, [REDACTED], Visalia, Own, Group 4)
- “Board, CEO. The people whose job it is.” – [REDACTED] (50-64, [REDACTED] Visalia, Own, Group 5)
- “...the employee can only see a certain level and then the board members see overall, so I would say a board member.” – [REDACTED] (30-39, [REDACTED], Visalia, Own, Group 5)

A small number of residents say that they would trust a combination of personnel, including a doctor, depending on “what kind of information you're looking for.”

- “I'd probably say a combination of the upper management, the head doctor and maybe a board member.” – [REDACTED] (40-49, [REDACTED], Visalia, Own, Group 4)
- “Well, I think it depends on what kind of information you're looking for and things change a lot...” – [REDACTED] (65+, [REDACTED], Visalia, Own, Group 1)
- “Medical personnel, a doctor, a nurse. I feel like they would be way more honest, as opposed to the leadership positions where they're loyal to their job and it often gets really politicized, so they just wouldn't give you the truth.” – [REDACTED] (18-29, [REDACTED] Visalia, Neither, Group 1)
- “I would say a doctor, they're in between nurses and administration. So I feel like they would have more of an idea of what's going on, they would have more knowledge.” – [REDACTED] (30-39, [REDACTED], Visalia, Own, Group 1)



Probolsky Research
100 Pine Street Suite 1250
San Francisco CA 94111

San Francisco (415) 870-8150
Newport Beach (949) 855-6400
Washington DC (202) 559-0270

Do you think Kaweah Delta is just a small-town hospital you go to because its close or a hospital you choose to go to for complex care?

Residents overwhelmingly see Kaweah Delta “as a small-town hospital you go to because its close”.

- Group #1: 7 of 11 small town
- Group #2: 7 of 11 small town
- Group #3: 9 of 14 small town
- Group #4: 6 of 9 small town
- Group #5: 9 of 10 small town

Although in the minority, residents that see Kaweah Delta as “a hospital you choose to go to for complex care” offer more intense and passionate responses that “you can do a lot” and are “satisfied over 100% with the cardiac treatment.”

- “No, it's beyond a small-town hospital... You can do a lot... It's amazing to me how it's changed in the last... 20 years.” – [REDACTED] (65+, [REDACTED], Visalia, Own, Group 1)
- “...I am totally pleased, satisfied over 100% with the cardiac treatment at the cardiac center. I wouldn't be here if they weren't adept at what they were doing, so I'm definitely sold on that...” – [REDACTED] (65+, [REDACTED], Visalia, Own, Group 5)
- “...I'm on the fence on both of them because it's a small-town hospital and it's here and I'm going to have to trust them... It's here and I'm going to use it, but I'm not going to lie. I got my next season done in Fresno that's this year.” – [REDACTED] (50-64, [REDACTED], Visalia, Own, Group 4)

Kaweah Delta is affiliated with the Cleveland Clinic for cardiac care, which has the No. 1 ranking heart program in the nation. Kaweah Delta is the only hospital in California that Cleveland Clinic affiliates with.

How does knowing this make you feel about getting cardiovascular/or heart care at Kaweah Delta?



Probolsky Research
100 Pine Street Suite 1250
San Francisco CA 94111

San Francisco (415) 870-8150
Newport Beach (949) 855-6400
Washington DC (202) 559-0270

Most residents are generally unaware of Kaweah Delta’s affiliation with the Cleveland Clinic, but all residents are impressed by the designation.

- “I think it's great to hear that they're the only one in California. That's phenomenal to hear something like that, especially in our area...” – █████ (30-39, █████, Visalia, Own, Group 1)
- “Yeah, I did know that they were affiliated with a teaching hospital and cardiac care is what they... They really do excel there. And so I would definitely go there for cardiac care.” – █████ (65+, █████, Visalia, Own, Group 1)
- “...Cleveland Clinic, the minute you said that...it puts it in a whole different category of top-notch hospitals in the world.” – █████ (50-64, █████, Visalia, Own, Group 3)
- “I think if, if it's the only hospital in California that Cleveland clinic is associated with, I think that's a pretty good affiliation...” – █████ (30-39, █████, Visalia, Own, Group 4)

Please tell me why it’s important to you that Kaweah Delta has the financial and medical resources to provide great quality care.

Residents overwhelmingly say that financial and medical resources are essential to attracting top staff to “keep the good doctors here” in order to provide high-quality care “in a more rural community”.

- “I think it's important that we have, they have that financial backing to keep the good doctors here...” – █████ (50-64, █████, Visalia, Own, Group 4)
- “Well, I have family members that have these extra medical conditions and what not. So it matters that we have somewhere close by that can perform and give quality service to these medical conditions.” – █████ (18-29, █████, Visalia, Neither, Group 1)
- “...it is the biggest hospital in this area, and this is what all the people in this area depend on. And it's also kind of a low-income community, and there are some very adversely-affected groups. So, I think that just because we do live in a more rural community that doesn't mean we shouldn't have access to that...” – █████ (18-29, █████, Visalia, Rent, Group 1)



Probolsky Research
100 Pine Street Suite 1250
San Francisco CA 94111

San Francisco (415) 870-8150
Newport Beach (949) 855-6400
Washington DC (202) 559-0270

- "... this being a rural facility, it's difficult to obtain quality physicians and healthcare professionals in the area. So having the resources to obtain the quality staff that they try to obtain is important so that the community does receive quality care." – [REDACTED] (65+, [REDACTED] Visalia, Own, Group 1)

Residents connect adequate financial and medical resources with their status as a rural community because in an emergency situation "you might not have that luxury of time to be able to travel to some of these other centers."

- "...you might not have that luxury of time to be able to travel to some of these other centers. So, you want to make sure you have it local within your community..." – [REDACTED] (30-39, [REDACTED], Visalia, Rent, Group 2)
- "Because I can never tell when I'm going to wind up in the hospital." – [REDACTED] (65+, [REDACTED], Visalia, Own, Group 3)
- "... just that sense of security, knowing that you don't have to be airlifted somewhere. All this stuff that you need is right there for you, is just a sense of security." – [REDACTED] (30-39, [REDACTED], Visalia, Rent, Group 3)
- "...since we moved here, we've looked forward to having Kaweah health be our go-to hospital..." – [REDACTED] (50-64, [REDACTED] Visalia, Own, Group 4)
- "...it's also good to know that they do have the proper equipment, proper staff, at all times to get that help in case something would ever happen. I would say it is important to me to know at least that it's there..." – [REDACTED] (40-49, [REDACTED], Visalia, Own, Group 5)

Residents say that financial resources are needed to have "the right medical supplies", "keep up on the latest technology", and ensure that the hospital is "sustainable".

- "...as far as being well-funded and having the right medical supplies, those two kind of go hand in hand because you want them to have the most up-to-date equipment as well..." – [REDACTED] (30-39, [REDACTED] Visalia, Own, Group 3)
- "Well, the financial resources at the hospital contribute to what kind of like hardware is available for surgery. How many ORs are available? How many MAs are available?..." – [REDACTED] (30-39, [REDACTED] Visalia, Own, Group 4)



Probolsky Research
100 Pine Street Suite 1250
San Francisco CA 94111

San Francisco (415) 870-8150
Newport Beach (949) 855-6400
Washington DC (202) 559-0270

- “We need it to be stable, sustainable...keeping up on the latest technology. It also means that we have to have those fiscal resources if we want to attract high quality personnel...” – [REDACTED] (50-64, [REDACTED] Visalia, Own, Group 5)
- “It is sustainable in the community. It's not going to disappear on us.” – [REDACTED] (65+, [REDACTED] Visalia, Own, Group 2)

Are you aware of any improvements that need to be made to Kaweah Delta facilities? How about improved parking, the buildings, or the equipment?

Most residents do not identify a specific need, but instead say that Kaweah Delta has “done a lot of improvements” and has been “redoing, revamping the emergency room.”

- “They've done a lot of improvements... Nothing right now.” – [REDACTED] (65+, [REDACTED], Visalia, Own, Group 1)
- “...for years the biggest complaint you heard from the public about Kaweah Delta was the ER. And you don't hear that so much anymore, because they worked on it, they've got better people running it. They have obviously expanded the facilities and it's a much bigger... I've spent Friday nights in the Kaweah Delta ER some years ago, and-... they were beautiful, they were great. But it was a mess. Because there were people all over the place, and... they had enough staff, but they didn't have the beds and that was a big problem.” – [REDACTED] (65+, [REDACTED], Visalia, Own, Group 1)
- “I know they're currently in the process of redoing revamping the emergency room...” – [REDACTED] (40-49, [REDACTED], Visalia, Rent, Group 4)

A small number of residents say that the parking needs to be improved – with one resident expressing support for additional staff.

- “I really think they need to improve the parking.” – [REDACTED] (40-49, [REDACTED], Ivanhoe, Own, Group 2)



Probolsky Research
100 Pine Street Suite 1250
San Francisco CA 94111

San Francisco (415) 870-8150
Newport Beach (949) 855-6400
Washington DC (202) 559-0270

- "... the main parking area for the Kaweah Delta Hospital is pretty bad with the traffic in that area..." – [REDACTED] (18-29, [REDACTED], Visalia, Rent, Group 3)
- "Parking's a disaster." – [REDACTED] (50-64, [REDACTED], Visalia, Own, Group 5)
- "I think that they probably need just more staff in general. There needs to be more, not just physicians, but also nursing staff available." – [REDACTED] (30-39, [REDACTED], Visalia, Rent, Group 2)

The Mineral King wing of Kaweah Delta was built over 50 years ago, before there were PCs, mobile phones, and before we landed on the moon, in 1969, and has not been significantly updated since. This wing contains 206 of the 435 beds Kaweah Delta has on the downtown campus. There is a need for a more modern facility to better serve patients, and the Mineral King Wing does not comply with state earthquake standards beyond 2030 and will need to be replaced.

Kaweah Delta is in the planning stages to build a new modern hospital wing. Do you support or oppose a new hospital wing being built? Why? Why not?

Residents overwhelmingly support modernization of the Mineral King wing of Kaweah Delta as essential – with nearly unanimous support in multiple groups because it is something that “we have to do”.

- "I supported it." – [REDACTED] 30-39, [REDACTED] Visalia, Own, Group 1)
- "We have to do it, we have to have it. We have to have a bigger, better facility. There's no question about it." [REDACTED] (65+, [REDACTED] Visalia, Own, Group 1)
- "It's always good to have updated things..." – [REDACTED] (40-49, [REDACTED] Visalia, Rent, Group 3)
- "...I think it makes the hospital more attractive to be updated." – [REDACTED] (30-39, [REDACTED] Visalia, Own, Group 3)

Residents see the new wing as linked to the need for more bed space as the community is growing.



Probolsky Research
100 Pine Street Suite 1250
San Francisco CA 94111

San Francisco (415) 870-8150
Newport Beach (949) 855-6400
Washington DC (202) 559-0270

- “I think so. Primary, so we don't lose that bed space as we saw during the pandemic. The room or need for services was just limited on how many services they could provide to the community...” – [REDACTED] (40-49, [REDACTED] Ivanhoe, Own, Group 2)
- “...we can't afford to lose essentially a third of the beds we have in the hospital. Walking through that wing, it's very outdated...” – [REDACTED] (30-39, [REDACTED], Visalia, Rent, Group 2)
- “Yeah. Obviously the community is growing, it's not going to shrink, so the need for a hospital or the need for Kaweah Delta is just going to continue to expand...” [REDACTED] (18-29, [REDACTED], Visalia, Rent, Group 2)
- “...if the population's growing in a town, then I think you need to expand to accommodate that.” – [REDACTED] (50-64, [REDACTED] Visalia, Own, Group 4)

What does modernize mean to you when thinking about a hospital?

Residents view modernization in terms of technology, citing “newer equipment,” “newer technology, medical supplies, equipment,” and “state-of-the-art therapies”.

- “... newer equipment ... modernizing the way people can interact with their health data... digitizing any information they might have that is still on hard paper, and then making it easily accessible by anyone that needs to get that information.....” – [REDACTED] (18-29, [REDACTED], Farmersville, Neither, Group 1)
- “To me, I think state-of-the-art, of the most new research-type therapies are being offered to me...” – [REDACTED] (30-39, [REDACTED] Visalia, Rent, Group 1)
- “... Newer technology, medical supplies, equipment...” – [REDACTED] (18-29, [REDACTED] Visalia, Neither, Group 1)
- “Maybe more technology based I've seen with the whole COVID thing happening, how some hospitals, they have almost a mobile robot checking in patients.” – [REDACTED] (30-39, [REDACTED] Visalia, Rent, Group 3)



Probolsky Research
100 Pine Street Suite 1250
San Francisco CA 94111

San Francisco (415) 870-8150
Newport Beach (949) 855-6400
Washington DC (202) 559-0270

- “I think of the surgical instruments, invasive procedures, and then also accessibility where there's closed captioning...” – ██████ (18-29, ██████, Visalia, Neither, Group 3)
- “...Modernize technology, going paperless, building, going electronic, being able to serve customers better on an electronic basis...” – ██████ (40-49, ██████, Visalia, Own, Group 4)

Several residents view modernization in terms of facilities that are earthquake retrofitted, have “structural modifications,” “adding facilities” ... “that can take care of all my medical needs.”

- “... I would hope that it would include retrofitting the original section up to earthquake standards...” – ██████ (50-64, ██████, Visalia, Own, Group 4)
- “... bringing within the earthquake requirements but also the computerized part of it...The electronic health record is a huge part of the updated modern services.” – ██████ (40-49, ██████, Visalia, Own, Group 2)
- “It could be structural modifications that they are in need of per the state, or it could be like they just did with the new ER. Adding facilities, adding areas or changing the use of a certain space to better suit the needs of the hospital.” – ██████ (30-39, ██████, Visalia, Own, Group 3)
- “Updated, trustworthy. I'm really looking for facilities that can take care of all my medical needs.” – ██████ (50-64, ██████, Visalia, Own, Group 5)

Residents say that modernizing means “better facilities and better staff” who are “trained on the newest technologies and systems”.

- “...it means better facilities and better staff.” – ██████ (65+, ██████, Visalia, Own, Group 1)
- “...making sure your staff is trained on the newest technologies and systems...” – ██████ (40-49, ██████, Visalia, Own, Group 4)



Probolsky Research
100 Pine Street Suite 1250
San Francisco CA 94111

San Francisco (415) 870-8150
Newport Beach (949) 855-6400
Washington DC (202) 559-0270

- "...Having people that are aware of the changes, having the personnel and the professionals that are on the cutting edge would be very helpful along with the update of the facilities." – [REDACTED] (65+, [REDACTED], Visalia, Rent, Group 5)

Measure H: In 2016, Measure H, a general obligation bond measure, failed to get enough support from voters. What do you know about Measure H?

Most residents are either new to the area, or are unaware of the 2016 Measure H general obligation bond measure.

- "I don't remember, I just remember hearing about it, but I can't remember in detail what it was about." – [REDACTED] (30-39, [REDACTED] Visalia, Own, Group 1)
- "... I just remember the voting cycle coming around and the different yard signs out. And then I remember hearing about why it failed..." – [REDACTED] 40-49, [REDACTED] Visalia, Own, Group 2)
- "I don't remember much, but I just remember there was a lot of bad publicity on why they wanted that bond to pass...." – [REDACTED] (40-49, [REDACTED], Ivanhoe, Own, Group 2)

Of residents that remember Measure H, residents say that the measure involved a disagreement about taxes.

- And this is this area's problem, because if you look at the map that was on the screen a little while ago, all of the area in white represents people who can use the facilities but don't pay taxes. And that's a serious problem." – [REDACTED] (65+, [REDACTED], Visalia, Own, Group 1)
- "I remember that Kaweah Delta was having a rough year that year, I think, and it seemed like they wanted to raise taxes a lot..." – [REDACTED] (30-39, [REDACTED], Visalia, Own, Group 2)
- "I think it was a bond to help build new or update the hospital. A lot of people were complaining they didn't want their taxes raised and that sort of thing." – [REDACTED] (40-49, [REDACTED] Visalia, Rent, Group 3)



Probolsky Research
100 Pine Street Suite 1250
San Francisco CA 94111

San Francisco (415) 870-8150
Newport Beach (949) 855-6400
Washington DC (202) 559-0270

- "...honestly didn't hear a lot about it, but for the election. And so just questioning on, you know, where the money goes..." – ██████ (40-49, ██████, Visalia, Own, Group 4)
- "... I know personally when I voted, a lot of the negativity was coming because as taxpayers, we've been paying into this." – ██████ (40-49, ██████ Visalia, Rent, Group 4)
- "They were going to raise property taxes again." – ██████ (50-64, ██████, Visalia, Other, Group 5)

Measure H- To provide life-saving emergency and medical care from newborns to seniors, to expand facilities for rapid treatment of trauma, heart attacks, and strokes, to improve facilities for treatment of cancer, diabetes and other diseases, to replace patient areas not meeting earthquake safety standards required by California law, to attract doctors, nurses and medical specialists to our community, shall Kaweah Delta Health Care District issue \$327,000,000 in bonds to improve critical care and essential hospital facilities?

To fund the repayment of these bonds, Measure H would have authorized a parcel tax of \$48.70 per year per \$100,000 assessed valuation on property.

Why do you think the bond measure failed in 2016?

Residents believe that Measure H failed because "people just don't want their taxes raised" to fund a bond for "a lot of money" without detailing "what their plan was to do with it".

- "I think that people just don't want their taxes raised" – ██████ (65+, ██████, Visalia, Own, Group 1)
- "...\$327 million seems like quite a bit when it doesn't seem like it's broke from the outside..." – ██████ (18-29, ██████, Visalia, Rent, Group 2)
- "... seems like a lot of money." – ██████ (30-39, ██████, Visalia, Own, Group 3)
- "I believe it was a property tax for only residents or property owners in Visalia and since the district is much larger than only Visalia and services many areas outside of just



Probolsky Research
100 Pine Street Suite 1250
San Francisco CA 94111

San Francisco (415) 870-8150
Newport Beach (949) 855-6400
Washington DC (202) 559-0270

Visalia, as well as just property owners in Visalia, most property owners didn't want to pay the whole bill.” – [REDACTED] (30-39, [REDACTED], Visalia, Own, Group 3)

- “...I don't know that the hospital did the best job, engaging the community and being detailed as far as what the statement says about what their plan was to do with it...” – [REDACTED] (40-49, [REDACTED] Visalia, Rent, Group 4)

Measure H or any future bond measure would only raise some of the money necessary to fund the cost of major hospital modernization and new construction. Kaweah Delta would raise other funds from hospital revenues, other loans, and grants. Does this make sense? Is it a good plan? Do you think there is any other way to accomplish the goal of having facilities to deliver high-quality healthcare?

Residents overwhelmingly agree that the District should explore every source of funding but are “cautious about the idea of them taking out loans” and “asking community for more than you're probably going to contribute”.

- “I think bonds are hard to get passed, because it's an extra tax. And everybody feels taxed to death in this state. So that's the tough part, but yeah, I mean there's a lot of sources of revenue, and they should explore every source.” – [REDACTED] (65+, [REDACTED], Visalia, Own, Group 1)
- “I think it's a good plan, it's always should be a combination...” – [REDACTED] (50-64, [REDACTED] Visalia, Own, Group 4)
- “...obviously you're asking community for more than you're probably going to contribute. So, that is definitely a little deterring.” – [REDACTED] (18-29, [REDACTED], Visalia, Neither, Group 3)
- “I feel cautious about the idea of them taking out loans on top of doing bond money...I mean you've got business loans. I just, I feel like where is the revenue going to come from to pay back that loan?” – [REDACTED] (30-39, [REDACTED], Visalia, Own, Group 4)

Is that something that concerns you, this idea that only people within the district pay the tax, but the Irvine guy can come up and use the hospital. Is that concerning to anybody?



Probolsky Research
100 Pine Street Suite 1250
San Francisco CA 94111

San Francisco (415) 870-8150
Newport Beach (949) 855-6400
Washington DC (202) 559-0270

Or the person just outside the district, right? Just two blocks' away and outside the district gets to use the hospital. Anybody concerned about that argument?

Residents generally believe that anyone should have access to the hospital, even if they do not pay for care.

- "...people outside of the district need help just like we do we can't expect that only our district is allowed to use that hospital. It doesn't make sense to me." – [REDACTED] (30-39, [REDACTED], Visalia, Own, Group 1)
- "I just can't imagine a hospital just saying, oh, we can't take it because of your zip code." – [REDACTED] (30-39, [REDACTED] Visalia, Rent, Group 1)
- "I would say that anyone that's paying taxes should contribute not just property owners. – [REDACTED] (50-64, [REDACTED], Visalia, Own, Group 3)

Some residents say it would be better if Kaweah Delta "expanded the amount of taxpayers."

- "... And if they expanded the amount of taxpayers, if it was including all the surrounding cities close by that are using Kaweah Delta and added it there, then I think that it might be better." – [REDACTED] (40-49, [REDACTED] Visalia, Rent, Group 4)
- "Well, I mean, it would make more sense for them to pay, to have the arbitrary line, furthered out if those people are going to use the facilities or not..." – [REDACTED] (18-29, [REDACTED], Visalia, Neither, Group 4)

After the failure of Measure H, Kaweah Delta committed to transparency and education and formed a Community Engagement Initiative. This initiative included ambassador groups, advisory groups, and public forums such as town halls and webinars. The initial goal was to involve community members in the planning of future facilities, to listen to feedback and concerns from the community, and to involve others in important measures to help build trust. More than 200 community members have participated in these community engagement groups. Do you feel like Kaweah Delta has done a good job expanding their outreach and trust in the community through social media, town halls, and virtual public forums?



Probolsky Research
100 Pine Street Suite 1250
San Francisco CA 94111

San Francisco (415) 870-8150
Newport Beach (949) 855-6400
Washington DC (202) 559-0270

Many residents say that the District has done “a good job with transparency” – with several saying that they have “seen the commitment” through a “a big push for education” and outreach “especially with social media...after COVID hit.”

- “I want to say yes. The last couple of years has been a big push for education for the high school and elementary schools and everything and the citizens as well...” – █████ (65+, █████, Visalia, Own, Group 2)
- “I want to say yes, especially with social media...after COVID hit, I started following their page to get the updates...” – █████ (18-29, █████, Visalia, Rent, Group 2)
- “I’ve seen the commitment. I was part of that ambassadors group. But no question, with COVID, they have really stepped it up and I thought they’ve done a very good job of trying to be as transparent and providing as much information as they possibly can...” – █████ (65+, █████, Visalia, Own, Group 2)
- “...I’m fairly involved with the city and I have not seen any of this stuff, I have not seen the plans. I have not seen anything about committees or citizen input or anything at all. So it seems like they are not getting the word out.” – █████ (65+, █████, Visalia, Own, Group 3)
- “I feel like they did a good job with transparency with COVID, with hospital issues related to COVID. And that they really came out as transparent and connected.” – █████ (50-64, █████, Visalia, Own, Group 5)

A small number of residents say that the District’s outreach is “poor” and “can definitely improve.”

- “I wouldn’t say it’s poor, but I think they can definitely improve on it.” – █████ (30-39, █████, Visalia, Own, Group 1)
- “That they conduct a transparent and public bidding process...” – █████ (50-64, █████, Visalia, Own, Group 4)
- “...They were disingenuous. So they proposed some of these community groups as advisory groups, and presented them as looking for input. But then they never permitted any of that input to be provided...” – █████ (50-64, █████, Visalia, Own, Group 5)



Probolsky Research
100 Pine Street Suite 1250
San Francisco CA 94111

San Francisco (415) 870-8150
Newport Beach (949) 855-6400
Washington DC (202) 559-0270

To develop a plan for replacing the Mineral King building, Kaweah Delta conducted an open and transparent public bidding process, and with input from the community members, they hired RBB as its architect. They were selected for their track record of building lower cost hospitals that are highly efficient — including a similar sized hospital in Merced. RBB has worked with Kaweah Delta leadership and consultants to create a facility plan to meet the community’s future healthcare facilities and technology needs. More than one dozen options for replacing the Mineral King wing were considered. The goal was to build a new wing to provide quality care for the next 50 years in the most affordable way. There are now two options being considered and Kaweah Delta is seeking additional feedback from the community before it decides between the two options.

Kaweah Delta, like any large organization, is always planning for the future. Let’s talk about hospital beds and hospital rooms.

Residents express support for knowing that the District “hired RBB because of their track record of building lower cost hospitals, they're highly efficient.”

- “They hired RBB because of their track record of building lower cost hospitals, they're highly efficient... They're trying to save money while at the same time trying to build the best quality while saving money at the same time.” – ██████████ (30-39, ██████████, Visalia, Own, Group 1)
- “I would say what stands out is they have the record of building lower cost hospitals that are highly efficient...” – ██████████ 18-29, ██████████ Indp., Visalia, Rent, Group 2)
- “I would say what stands out is they have the record of building lower cost hospitals that are highly efficient...” – ██████████ (18-29, ██████████ Visalia, Rent, Group 2)
- “...They're saying that they're highly efficient even though it's lower cost. So they're obviously trying to save and cut corners here...” – ██████████ (40-49, ██████████, Visalia, Rent, Group 4)

A small number of residents express skepticism about how the designer and architectural group were selected.



Probolsky Research
100 Pine Street Suite 1250
San Francisco CA 94111

San Francisco (415) 870-8150
Newport Beach (949) 855-6400
Washington DC (202) 559-0270

- “They can't afford to clean the hospital because a lot of it is really super dirty, but we can afford to hire someone to design a hospital for us.” – [REDACTED] (50-64, [REDACTED] Visalia, Other, Group 5)
- “...So this architectural group, from what I gathered from this, came up with a dozen options. And who are on the committee to decide what's the best option and to crunch the numbers?” – [REDACTED] (65+, [REDACTED] Visalia, Rent, Group 5)

Let's look at some images of patient hospital rooms. The current patient rooms in the Mineral King Wing are pie shaped and not conducive to a positive patient experience. They are cramped at 118 square feet, lack space for visitors, and modern healthcare equipment. Patient beds are up against one wall which limits access to a patient and limits the number of staff who can help a patient.

The Acequia Wing patient rooms are a bit larger and safer at 149 square feet and has limited space for visiting family and modern medical equipment.

The proposed new wing patient rooms would be consistent with current best practices in hospital design, which includes larger rooms at 175 square feet, have a proper bathroom experience, room for medical equipment and safer overall and allow family members to stay overnight with their loved ones.

Patients agree that the current “pie-shaped” rooms are cramped and offer a poor patient experience, especially when additional equipment is brought into the room. Residents overwhelmingly prefer the “ideal patient” room, which “ allows for family members to stay”.

- “I think the ideal patient room is ideal because I have been a patient in the pie-shaped room and I think that when you have a patient and you have all the equipment that goes into caring for a patient, and you're bringing in IVs and EKG machines and all that other stuff, you need space in order for all of that equipment to be brought into the room. Along with radiology equipment when they come in to do an X-ray and having room to move around makes for a better experience.” – [REDACTED] (65+, [REDACTED], Visalia, Own, Group 1)
- “... Not only is it going to be a better experience for the patients, but for staff, you get injuries all the time. ... A lot of patients that are immobile, bedridden, they need help repositioning in the bed...” – [REDACTED] (30-39, [REDACTED], Visalia, Own, Group 1)



Probolsky Research
100 Pine Street Suite 1250
San Francisco CA 94111

San Francisco (415) 870-8150
Newport Beach (949) 855-6400
Washington DC (202) 559-0270

- “I've been in the pie-shaped rooms dozens of times... It's just so awkward and it's really uncomfortable, and you're just kind of like lumped together. I don't know, the ideal plan is the way to go instead of the pie-shaped room.” – █████ (18-29, █████, Visalia, Neither, Group 1)
- “I appreciate the fact that the ideal patient room allows for family members to stay overnight. So my grandfather, he spent quite a bit of time in the hospital and he's been there for weeks on end without really having the support that he needs with his family because he's there mostly alone for the majority of the time.” – █████ (30-39, █████, Visalia, Own, Group 1)
- “...I can remember there were people literally standing in that little bathroom area”. – █████ (40-49, █████, Visalia, Own, Group 2)
- “... I've also been in current patient rooms in the Mineral King Wing and they're just way too cramped...” – █████ (18-29, █████, Visalia, Neither, Group 3)
- “No, that's just terrible when they can't stay with their loved ones like that. Yeah. I've been in one of those rooms and they're not comfortable at all, not comfortable. They're not conducive to have family or anybody there.” – █████ (50-64, █████, Visalia, Own, Group 4)
- “Yeah, the Mineral King room looks like a prison cell.” – █████ (50-64, █████, Visalia, Own, Group 4)

Residents agree that newer, “Acequia Wing” patient rooms are much bigger, safer and have better medical equipment.

- “... It allows more room for moderate equipment, allows family members to stay overnight, et cetera. All those things are really positive and might make a difference to people.” – █████ (65+, █████, Visalia, Own, Group 3)
- “...I've been in both the hospital rooms in the new and the old. The newer are so much better already...” – █████ (40-49, █████, Visalia, Rent, Group 4)



Probolsky Research
 100 Pine Street Suite 1250
 San Francisco CA 94111

San Francisco (415) 870-8150
 Newport Beach (949) 855-6400
 Washington DC (202) 559-0270

- “Yeah. I like all the space on the new one. I think a lot of times we want our family to come visit us and they don't fit. And I'm all for it, the new layout on the new one...” – [REDACTED] (40-49, [REDACTED], Visalia, Own, Group 5)
- “Because the room for the Acequia, it's big, it's really, really big... So that is definitely adequate.” – [REDACTED] (50-64, [REDACTED], Visalia, Other, Group 5)

Now let's look at both options and their phases. Which one do you like more and why?

Option 1: The first tower (Phase I) will be built and operated for several years before the plan for building the second tower (Phase II) is started. This option does give Kaweah Delta the flexibility as the community needs change. For example, they could build the second tower larger or smaller based on those needs.

Option 2: This tower would be built at one time, but the top four floors would be shells and the hospital would later build them out floor by floor as needed.

Residents generally prefer the “cheaper” Option 2, citing less congestion and the elimination of elevator waiting time and congestion.

- “Well, that the second option is cheaper. Save quite a bit of money. What is it like over 200 million you'd be saving? So in my opinion, that's the way to go.” – [REDACTED] (30-39, [REDACTED], Visalia, Own, Group 1)
- “For me, I think option two makes more sense. Even though I do like the ability of having multiple buildings to have set places and people can go. It's a little bit less congested instead of having everything in one building going up and down. But I just think having the ability to expand later on, or just having that one building is pretty important.” – [REDACTED] (18-29, [REDACTED], Farmersville, Neither, Group 1)
- “Well, option two is more cost-effective, but the other thing is that a has nine floors. So if you're... That elevator is going up and down, you'd have to wait for the top floor to come all the way to the bottom floor. So there's congestions with elevators. And with the other ones, there's just four floors on one and five on the other. So it makes the elevator use a little easier, and if you're running up and down stairs, going up nine flights of stairs



Probolsky Research
100 Pine Street Suite 1250
San Francisco CA 94111

San Francisco (415) 870-8150
Newport Beach (949) 855-6400
Washington DC (202) 559-0270

versus four flights of stairs is a whole lot easier.” – █████ (65+, █████, Visalia, Own, Group 1)

- “...I voted option two... I feel like it smaller footprint as far as on the floor, which leaves the possibility for future development...It looked like it was cheaper by potentially 100 plus million dollars...” – █████ (50-64, █████, Visalia, Own, Group 2)
- “I liked the flexibility of all of this is based on projections and when exactly you bring on your additional capacity can be very flexible. You can infill those shells over a period of time to meet your demand and do it in a much more cost-effective way than building a second building.” – █████ (65+, █████, Visalia, Own, Group 2)
- “The overall price I think was a little bit lower for this one. And it also leaves more space to build in the future if we need to build a second tower or another tower in the future.” – █████ (30-39, █████, Visalia, Own, Group 3)
- “Well, I think, Adam, economies of scale, for one. It's a whole lot easier to build one building than two buildings...” – █████ (65+, █████, Visalia, Own, Group 5)
- “Because if you do one tower, it leaves the ground space open for the second tower later on when we need to expand even more.” – █████ (50-64, █████, Visalia, Own, Group 5)

Of residents that prefer Option 1, they cite the “phase approach” because it leaves more room for error and corrections.

- “I think the phase approach is a good idea, because you could also have lessons learned right from the first phase before you enter the second phase...” – █████ (30-39, █████, Visalia, Own, Group 4)
- “I liked the first one a little bit better, because I feel like there's more room for error so that if they say, "Okay, we've got the first tower and we decided that the area is growing way faster than we thought and so now we're going to need to up it to 200 beds instead of 120 beds," then that's something they could work into the second tower. I also noticed



Probolsky Research
100 Pine Street Suite 1250
San Francisco CA 94111

San Francisco (415) 870-8150
Newport Beach (949) 855-6400
Washington DC (202) 559-0270

that the car parking structure is almost half the size in the single tower versus the double tower...” – [REDACTED] (30-39, [REDACTED], Visalia, Own, Group 4)

- “...If they were two separate buildings, I think would equal more room.” – [REDACTED] (30-39, [REDACTED], Visalia, Own, Group 2)
- “...I just like the layout of option one better.” – [REDACTED] (30-39, [REDACTED] Visalia, Rent, Group 2)
- “I like the idea of maybe saving space on the ground, but I think dividing it and maybe like each one having like their own purpose would be a good idea for having two towers.” – [REDACTED] (18-29, [REDACTED], Visalia, Own, Group 2)

Bond Measure – Future: Paying for all the needed new or updated hospital facilities could cost as much as \$500 million or more. Kaweah Delta does not have all the money to pay for this and would need to raise a portion of the funds through a bond measure. As a public hospital, Kaweah Delta treats all patients regardless of their insurance or their ability to pay for services. Tulare County is among the poorest counties in California and has the highest percentage of patients covered by Medi-Cal, which pays hospitals the lowest rates. As a result, Kaweah Delta is paid much less than most hospitals in the state.

Would you support or oppose a bond measure to pay for the updates needed? Why or why not? If not (or if you are not sure), what additional information would you like to see from Kaweah Delta to help you make up your mind?

Residents overwhelmingly say that they would support a bond measure.

- Group #1: 8 of 11
- Group #2: 8 of 11
- Group #3: 11 of 14
- Group #4: 7 of 9
- Group #5: 10 of 10
- “It was just increase taxes by a little bit, or just increase taxes from my check. But I honestly wouldn't mind it as long as I know it's going towards something like building the hospital improving it, I'd be all for it.” – [REDACTED] (18-29, [REDACTED], Visalia, Rent, Group 3)



Probolsky Research
100 Pine Street Suite 1250
San Francisco CA 94111

San Francisco (415) 870-8150
Newport Beach (949) 855-6400
Washington DC (202) 559-0270

- "... We're all homeowners so our home values would potentially increase because we have a state of the art facility right here in Visalia." – ██████ (30-39, ██████, Visalia, Own, Group 3)

Residents say that the bond measure will provide the community with medical services that are needed.

- "... We want those cardio logical services, those neurological services, orthopedic surgery or whatnot. That's something that we have to all pitch in if we all want to reap the benefits of that when the time comes that we may need it." – ██████ (30-39, ██████, Visalia, Rent, Group 2)
- "... We're not going to get smaller and we need the services just what ██████ (30-39, ██████, Visalia, Rent, Group 2) was saying for the future, we need to have these services available for our community." – ██████ (65+, ██████, Visalia, Own, Group 2)

Of residents opposed to the bond measure, they say that they already pay enough in taxes.

- "Yeah, I already pay lot in taxes and I wouldn't want... I own my own house and the property taxes is a lot. Then I get taxed a lot already from work and then sales tax, it's just ridiculous. I would not want more to pay more taxes than what I already do." – ██████ (30-39, ██████, Visalia, Own, Group 1)
- "I'm on the fence." – ██████ (65+, ██████, Visalia, Own, Group 1)
- "It seems like it's just another tax that we're going to have to be paying for something else..." – ██████ (30-39, ██████, Visalia, Own, Group 2)
- "Because I think they need more beds and more staffing and they need the upgrades." – ██████ (40-49, ██████, Visalia, Rent, Group 4)
- "...I think this community is growing ...So I think that it needs it to accommodate its population and it needs to stay up with the times..." – ██████ (50-64, ██████, Visalia, Own, Group 4)



Probolsky Research
 100 Pine Street Suite 1250
 San Francisco CA 94111

San Francisco (415) 870-8150
 Newport Beach (949) 855-6400
 Washington DC (202) 559-0270

In option one with two towers, it will cost approximately \$684 million dollars to fund hospital updates and new facilities. This would be \$319 million for Phase I and \$365 million for Phase II. Kaweah Delta would work with banks and other institutions to borrow as much money as it can to fund this project. Assuming that Kaweah Delta could borrow half of the money, Kaweah Delta would pay for \$160 million and taxpayers would be asked to pay for \$159 million for Phase I.

Then, a few years later when Phase II is started, Kaweah Delta would pay for an additional \$183 million, and taxpayers would pay for the other \$182 million. The total of the two bonds that taxpayers would be asked to repay would be approximately \$342 million. An average property owner would pay an additional tax of \$35.55 per year for every \$100,000 of assessed value (rates vary per year with the first year being \$17.30 per \$100,000 and the highest year being \$67.70 per \$100,000). For thirty years. So, for a \$400,000 house, the homeowner would pay approximately \$142.20 per year. (This number is based on the average amount of \$35.55 per \$100,000 assessed value.)

Do you think this is reasonable? Would be willing to support this? Why or why not?

Option 1: Residents overwhelmingly express support for the bond measure when told that the approximate cost is \$142 per year for a homeowner with a \$400,000 home.

- “Yeah, I do agree. I think it's going to serve our community and not to minimize anybody else's like financial situation and the amount of taxes that were pushed on us every single year. I personally don't think that that's much and it'll pay off.” – [REDACTED] (18-29, [REDACTED] Visalia, Neither, Group 1)
- “For 30 years it would be a little over four grand in taxes. It doesn't... Not as much as I thought it was going to be when you put it in numbers... Well, yeah, actually I'm more open to it now seeing the numbers. Now that I can visualize it \$4,260 is not a lot compared to other taxes that we pay.” – [REDACTED] (30-39, [REDACTED], Visalia, Rent, Group 1)
- “I think it needs to be done. I think that's the obligation that we take on as homeowners in the district. It's got to be done. Nobody wants to be taxed. I don't want to pay another \$150 a year, but I will potentially be using the institution, as well as family members.



Probolsky Research
100 Pine Street Suite 1250
San Francisco CA 94111

San Francisco (415) 870-8150
Newport Beach (949) 855-6400
Washington DC (202) 559-0270

When you live in an area, you have to support the area.” – [REDACTED] 65+, [REDACTED], Visalia, Own, Group 1)

- “I don't necessarily think that the \$400,000 housing price is a good lens to look through it in this perspective, just because the average cost of a home in Tulare County is only like \$250,000, so it'll be even less than that. I think even at \$400,000 with \$142 a year, I still think that's a reasonable price, but most people won't even pay that much for it.” – [REDACTED] (18-29, [REDACTED] Visalia, Rent, Group 1)
- “...it's like healthcare has got to be in the top three of what taxes are for and between law enforcement. So it's kind of like it's reasonable.” – [REDACTED] (40-49, [REDACTED], Visalia, Own, Group 2)
- “...I would say that I think reasonable is a good way to put it. And if we want to be able to continue to use services... All of us are getting benefit from it.” – [REDACTED] (40-49, [REDACTED] Visalia, Own, Group 2)
- “Ultimately I think only a 100 and something a year is not too bad to invest in our community and the resources that we need to upgrade and give us the improvements we need at our hospital...” – [REDACTED] (40-49, [REDACTED] Visalia, Rent, Group 4)

Some residents say that they would “need more information” and for the District “to sell me” and “give me a vision of something.”

- “...It seems like there needs to be advocacy on different levels to get money, to fund things properly, to take care of human beings who live here.” – [REDACTED] (50-64, [REDACTED], Visalia, Own, Group 3)
- “...I think for me personally what it would take was them selling me on their vision and what they care to do with this before I would ever even think about consider voting yes on any of these issues. They'd have to sell me in their confidence. They'd have to give me a vision of something. ...” – [REDACTED] (30-39, [REDACTED], Visalia, Own, Group 3)



Probolsky Research
100 Pine Street Suite 1250
San Francisco CA 94111

San Francisco (415) 870-8150
Newport Beach (949) 855-6400
Washington DC (202) 559-0270

- “I’m not saying no, I just feel like I would need more information. I’d want to see more before I committed to one way or the other.” – ██████ (40-49, ██████, Visalia, Rent, Group 4)

In option 2 with one tower, it would cost approximately \$542 million to fund hospital updates and new facilities. Kaweah Delta would borrow as much as it can to fund this project. Assuming, again, that Kaweah Delta would borrow half of the project cost, Kaweah Delta would pay for \$220 million and taxpayers would be asked to pay for \$220 million for Phase I. Then, a few years later when Phase II is started, Kaweah Delta would pay for an additional \$51 million, and taxpayers would pay for the other \$50 million. The total of the two bonds that taxpayers could be asked to repay would be approximately \$270 million. An average property owner would pay an additional tax of approximately \$31.93 per year for every \$100,000 of assessed value (rates vary per year with the first year being \$25.56 per \$100,000 and the highest year being \$62.15 per \$100,000). For thirty years. So, for a \$400,000 house, the homeowner would pay approximately \$127.72 per year. (This number is based on the average amount of \$31.93 per \$100,000 assessed value.) Do you think this is reasonable?

Would be willing to support this? Why or why not?

Residents express less support for Option 2 but are generally open to it.

- “I’m not sold on either one. I would like to know a little history on this kind of building and how it really plays out and works. I agree with the lady who was talking about the elevator issues. That sounds like a real problem. The more levels you have, potentially more problems.” – ██████ (65+, ██████, Visalia, Own, Group 1)
- “Everything going up... it seems like is that a reasonable amount but once you start adding three or four reasonable amounts, it starting to pay at the end of the month and end of the year, that the way I think about it.” – ██████ (40-49, ██████, Visalia, Own, Group 2)
- “I think we're going to have to pass a bond either way because of the issue coming up that ends in 2030. So we're going to have to pass something, but I think they're going to need to do a better job showing us what it's going to be and that their numbers are going to be accurate. I think that's where they failed last time.” – ██████ (40-49, ██████, Visalia, Rent, Group 4)



Probolsky Research
100 Pine Street Suite 1250
San Francisco CA 94111

San Francisco (415) 870-8150
Newport Beach (949) 855-6400
Washington DC (202) 559-0270

Some residents are skeptical about the property tax estimates, saying that “it always goes for the highest amount” and that “the homeowner gets hit with everything.”

- “My experience is it never lands on the lowest amount. It always goes for the highest amount... So I just have a hard time believing...” – [REDACTED] (50-64, [REDACTED] Visalia, Other, Group 5)
- “The reason I'm not is it seems like the homeowner gets hit with everything. You're talking about... That's not a lot of money, no, but when you consider everything else that's tagged on to the homeowner as far as property taxes are concerned, it becomes a big issue.” – [REDACTED] (65+, [REDACTED], Visalia, Own, Group 5)

How would you explain it to your neighbors and the broader public? How would you describe what we talked about so far tonight to a friend? How would you describe the need for the facility and the costs and how it would be paid for?

In explaining the issue to their friends or neighbors, residents would first describe “an actual need” for facility improvements, especially earthquake retrofitting, then would explain that a bond measure would pay for it. A small number would reference the impact on local jobs and the economy.

- “There's an actual need for the Kaweah Delta to build a new wing, that's up to standards by 2030 for earthquake stuff. There might be some kind of a bond [inaudible 01:34:55] to get half the money needed to proceed with that construction. There are different styles of the building that we can choose and each one will affect us differently, in which way we get taxed.” – [REDACTED] (18-29, [REDACTED] Farmersville, Neither, Group 1)
- “...there's a need for Kaweah Delta to modernize and update that wing. I think it would be our job to help contribute because we are one of the poorest counties in California and Kaweah Delta itself is not going to get the money and these facilities are necessary. So I think a raise in our taxes would be fine to help contribute to it.” – [REDACTED] (30-39, [REDACTED] Visalia, Own, Group 1)



Probolsky Research
100 Pine Street Suite 1250
San Francisco CA 94111

San Francisco (415) 870-8150
Newport Beach (949) 855-6400
Washington DC (202) 559-0270

- “...there needs to be an upgrade. You mentioned that by 2030, the upgrade has to happen because of the earthquake. Why not take that and bring it upon us as community members to support this initiative, because it does impact our community. We are an underprivileged area. It is what it is, and why not modernize it and give the best healthcare out there for our low-income members?” – █████ (30-39, █████, Visalia, Rent, Group 1)
- “...you first explain the need of why the expansion or why the building needs to take place and then explain the resources that shows a commitment from Kaweah Delta as well to the community to share the cost.” – █████ (40-49, █████, Ivanhoe, Own, Group 2)
- “If they don't make these changes, more than 200 beds are going to be lost...I think it's nice and easy that you can say they're paying for half and the community's paying for half, that makes it really easy to communicate.” – █████ (40-49, █████, Visalia, Own, Group 2)
- “...it's a necessary thing for our community to update our hospital. It's old, it's outdated, we need the new facility. It's great to have state of the line buildings and modernized healthcare facility in our own backyard. It's going to increase our home values and it's only going to be about \$150 a year.” – █████ (30-39, █████, Visalia, Own, Group 3)
- “Well, I think it's going back to helping the community and the hospitals dated. We need upgrades and we want to be a thriving community for the next generation, we need to invest in the future.” – █████ (40-49, █████, Visalia, Own, Group 4)
- “I would definitely encourage the bond as well, and just kind of piggyback on what everybody else said with regards to the importance of having it here within our community, importance of having the advanced medical facility available with all the latest technology and gadgets to assist all the nurses and doctors to provide the kinds of services that you said...” – █████ (50-64, █████, Visalia, Own, Group 4)
- “...but I think I would focus on the fact that that is money well spent that's going to benefit every single person in the district...” – █████ (50-64, █████, Visalia, Own, Group 5)



Probolsky Research
 100 Pine Street Suite 1250
 San Francisco CA 94111

San Francisco (415) 870-8150
 Newport Beach (949) 855-6400
 Washington DC (202) 559-0270

- “Vote for it. We need it. We need to expand. It needs to stay in the current location...” – [REDACTED] (50-64, [REDACTED], Visalia, Own, Group 5)
- “... it something that we all need it in the community, and we all have to contribute our part...” – [REDACTED] (30-39, [REDACTED], Visalia, Own, Group 5)
- “I would say...that later it'd be providing more jobs, making conditions a lot better for the hospitals...” – [REDACTED] (18-29, [REDACTED], Visalia, Rent, Group 3)
- “I am optimistic, I would hope that this is going to bring in more jobs for the community. I would hope that it would increase productivity and to make our community feel safer and be able to feel more secure when we do have emergencies.” – [REDACTED] (18-29, [REDACTED] Visalia, Neither, Group 3)

Kaweah Delta has revenues of \$734M a year and the health care district receives \$1.2 million in property taxes and \$3.1 million to pay back Measure M bonds (passed in 2003) from property owners. By example, it costs \$1.8 million a day to operate Kaweah Delta. And the District has approximately \$60 million in COVID-19 related losses. The District has reserves totaling approximately \$316 million (about 176 days of operating capital). The District has resources to provide world-class patient care and maintain and make modest improvements to facilities. The District does not however have the resources to build a new hospital, which is needed, that would cost hundreds of millions of dollars. Does this make sense? What do you think about all that?

Residents support issuing a bond – while maintaining reserves in the bank— in order to prepare for the unexpected.

- “Absolutely... I think that's okay because they're our major hospital, and we need to make sure they have resources to keep running while we do need to pay for this. If they used all that to help pay or a majority of it, then that kind of limits them if something does come up and they need that money... I want to make sure they're financially stable and ready for whatever comes their way. I mean, COVID, they're already having some



Probolsky Research
100 Pine Street Suite 1250
San Francisco CA 94111

San Francisco (415) 870-8150
Newport Beach (949) 855-6400
Washington DC (202) 559-0270

losses. If we used all that, and something happened again, it's not great.” – [REDACTED] (30-39, [REDACTED], Visalia, Own, Group 1)

- “...Keeping that money in the bank is beneficial for everybody.” – [REDACTED] (65+, [REDACTED], Visalia, Own, Group 1)
- “... that doesn't mean they're like bankrolling and stuffing the money under the mattress. I mean, they have to have money to keep paying their normal bills, just like you and I do...” – [REDACTED] (40-49, [REDACTED], Visalia, Rent, Group 3)
- “...So I would think that having that amount of money is just something, that's a good idea to have in case something else. Another emergency happens where they need to pay for the cost of operations without as much inflow of money coming in.” – [REDACTED] (30-39, [REDACTED], Visalia, Rent, Group 3)
- “I don't think so. I think it's important to have off for about six months of operating budget in the bank. That's pretty typical of most businesses.” – [REDACTED] (40-49, [REDACTED], Visalia, Own, Group 4)
- “So they have to have reserves to get them through all of the delays that they have and actually getting paid.” – [REDACTED] (50-64, [REDACTED], Visalia, Own, Group 5)
- “... It's nice to know and to feel that the hospital does have reserves and the fact that it is not operating at a deficit, that I think is very comforting...” – [REDACTED] (65+, [REDACTED], Visalia, Own, Group 5)

Kaweah Delta is going to pay a large portion of the costs of whatever option is chosen. Is that the way you'd characterize it? We've talked about Kaweah Delta paying about half and then the taxpayer's paying about half. Does that make sense to you or is there a different way of saying it?

How would you talk about them? Would you call them a nonprofit? Would you call them a not-for-profit? Would you call it a public hospital? What's the words that you would use to describe the hospital as it is? Lorraine, what would you say? What do you call them?



Probolsky Research
100 Pine Street Suite 1250
San Francisco CA 94111

San Francisco (415) 870-8150
Newport Beach (949) 855-6400
Washington DC (202) 559-0270

In Group 1, several residents expressed confusion over Kaweah Delta’s status as a for-profit or non-profit hospital – with the preferred description as “a public hospital”.

- “Oh, I don't know. I think, obviously the objective is to promote fairness. Half is coming from here and half is coming from there, and that seems fair, but it is a for-profit hospital. I realize we're in the poorest county in the state. I don't see any other way to do it.” – [REDACTED] (65+, [REDACTED], Visalia, Own, Group 1)
- “It's a for-profit hospital. It's not a charity hospital. That's all I was getting at. I wasn't saying that they were always trying to make a buck. What I meant is that there that they run it as a business and they have to pay the bills and they require community support. It's not a charity, coming from the Catholic Church, for instance, or some other source. It's run like a business. When you go to the hospital, you get a bill and you pay for services.” – [REDACTED] (65+, [REDACTED] Visalia, Own, Group 1)
- “Okay, it's a nonprofit district hospital, and the difference is that a for-profit hospital is run by a corporation, and that for-profit, the profit is given to the board. The board on a district hospital receives no funds. There's no benefit to the profit-sharing group.” – [REDACTED] (65+, [REDACTED] Visalia, Own, Group 1)
- “I guess in the most simplest of terms, I might say something like a public hospital.” – [REDACTED] (18-29, [REDACTED] Farmersville, Neither, Group 1)

Kaweah Delta has met with surrounding healthcare districts that do not have hospitals to discuss merging healthcare districts or evaluating options that would allow the other districts to help support Kaweah Delta’s building of a replacement facility. How do you feel about other health care districts consolidating with Kaweah Delta? What concerns do you have if this happened? Would this change your feelings about people outside of the Kaweah Delta Health Care District receiving care at Kaweah Delta.

Residents generally support the idea of expanding the map and consolidating with other “more impoverished areas,” especially if those communities are “going to be using the services.”



Probolsky Research
100 Pine Street Suite 1250
San Francisco CA 94111

San Francisco (415) 870-8150
Newport Beach (949) 855-6400
Washington DC (202) 559-0270

- “...since we're going into more impoverished areas, then do we really need to tax those people?” – [REDACTED] (18-29, [REDACTED] Visalia, Rent, Group 1)
- “...if you look at Farmerville and the mean income in Farmerville, it's not sky high. It's not like we're excluding some millionaire that's outside of our boundaries. We're going to be serving people that come in from outside, just like Fresno's serving people that are driving up there, so I don't know that redrawing is going to be the answer.” – [REDACTED] (30-39, [REDACTED] Visalia, Own, Group 4)
- “Just the fact that if they're going to be using the services, if they know that they're going to be consistently using the services, that there's going to be an agreement between the two affiliations, then it would make sense that they would help to fit the bill as well.” – [REDACTED] (40-49, [REDACTED] Visalia, Own, Group 2)
- “I think absolutely.” – [REDACTED] (30-39, [REDACTED] Visalia, Own, Group 5)

Much of the advanced care available at Kaweah Delta (open heart surgery, neurosurgery, cancer care, etc.) would not be available at Kaweah Delta if the hospital didn't serve patients from outside the health care district. When people from outside the district seek care at Kaweah Delta, the bills they pay help to support additional services at the hospital.

Does this change the way you feel about them being able to access care at Kaweah Delta?

Residents are generally unpersuaded by the connection between offering services to those living outside the area and its relationship to additional medical service offerings.

- “The practical matter is that a large percentage of people's bills are being paid by either insurance, Medicare, Medi-Cal. It doesn't make any difference where they live. That's who's paying the bill. So it's not a total question of hoards of people coming into the Kaweah Delta district and using services here and not paying for it. That happens. There's no question about it. But it's not as stark.” – [REDACTED] (65+, [REDACTED] Visalia, Own, Group 1)



Probolsky Research
100 Pine Street Suite 1250
San Francisco CA 94111

San Francisco (415) 870-8150
Newport Beach (949) 855-6400
Washington DC (202) 559-0270

- I think the hospitals are for people and I don't care where they're from..." – [REDACTED] (30-39, [REDACTED] Visalia, Own, Group 3)
- "...I think there's always going to be a certain portion of the population because of socioeconomic status that just doesn't have the resources to chip in. And what are you going to do? Say, "Well, you people don't get medical care." We can't do that. That's inhumane." – [REDACTED] (50-64, [REDACTED] Visalia, Own, Group 5)
- "That they are paying their bills and that's improving the quality of the hospital." – [REDACTED] (30-39, [REDACTED] Visalia, Own, Group 1)

What do you think about the idea of a bond measure? How do you think a bond for Kaweah Delta would impact you? What about timing, should it come before voters in the next couple of years or later like 5-6 years from now?

Residents say that they would like to see action on a bond measure sooner rather than later.

- "...that's encouraging me to vote because it gives me the sense that, Oh, we're sharing, it's not just putting it all on us, we're sharing the burden." – [REDACTED] (50-64, [REDACTED] Visalia, Own, Group 2)
- "... We are somebody's Fresno. We are somebody's Clovis hospital. So, just increasing other people who are contributing to our hospital would be beneficial." – [REDACTED] (18-29, [REDACTED] Visalia, Neither, Group 3)



Probolsky Research
 100 Pine Street Suite 1250
 San Francisco CA 94111

San Francisco (415) 870-8150
 Newport Beach (949) 855-6400
 Washington DC (202) 559-0270

Appendix A: Discussion Guide

Kaweah Delta Health Care District — Focus Group Discussion Guide

>>>Urge bathroom visit before start.

>>>Hide non-video participants

>>>We may mute you — Zoom power user tip — press space bar to talk

Good evening and welcome to our discussion group. Thank you for taking the time to join us this evening to discuss Kaweah Delta Health Care District.

My name is Adam Probolsky, I run a research company, and assisting me today are _____ and _____. Our goal this evening is to have an open discussion.

You were invited because _____.

This discussion is being conducted for research purposes only. No one will follow up or try to sell you any kind of product or service.

I will be available after our session to answer any questions.

As you can see, our discussion this evening **will be recorded**. We are recording the session because **we don't want to miss anything** that we all say.

For privacy reasons, we will be on a first name only basis.



Probolsky Research
100 Pine Street Suite 1250
San Francisco CA 94111

San Francisco (415) 870-8150
Newport Beach (949) 855-6400
Washington DC (202) 559-0270

Understanding this, may I quickly **confirm that is it all right with each of you to record this discussion?** Everyone please **signify your permission by saying, “yes”**.

Discussion Group Ground Rules

Since each person’s comments are important, I ask that **only one person speak at a time**. This will help us to hear one another.

Please **direct all comments toward me and speak up. No side conversations please.**

There is **no such thing as a right or wrong answer**, just differing points of view.

Tell us what you honestly think, and **feel free to share whatever is on your mind**.

We're just as **interested in negative comments as positive comments**.

We want everyone to participate, but **no one to dominate the conversation**.

If you **disagree with something that you hear, let us know**.

If you **agree, try to add more than just, “I agree,” by sharing your own perspective**.

My role is not to express my opinions, but I will bring up some ideas and see what you think about them. And I **will at times move the conversation along** to make sure I can get us out of here on time.

And now for a few things on using this Zoom platform. I may be asking you to **TYPE** your answers into the chat section rather than say it out loud. Can everyone click on the chat icon at the bottom of the Zoom window and type “got it”?

Warm-up

Let's find out some more about one another by going around the group.

Say your first name and something fun or interesting about yourself in 6 seconds or less. Let’s start with you. *[Indicate one group member to start and go through the group.]*



Probolsky Research
100 Pine Street Suite 1250
San Francisco CA 94111

San Francisco (415) 870-8150
Newport Beach (949) 855-6400
Washington DC (202) 559-0270

Initial Questions

- 1) What do you know of Kaweah Delta?
- 2) What do you like about Kaweah Delta?
- 3) What don't you like about Kaweah Delta?

[SHOW SLIDE]

- 4) Kaweah Delta was founded in 1961 as a type of local government agency called a hospital district. Now it is the largest hospital in Tulare County and a certified level III Trauma Center. More than 5,100 employees work for Kaweah Delta plus 600 medical staff are affiliated with the hospital. With eight-campuses the hospital has over 613 beds and is the only local hospital in Visalia. Kaweah Delta offers comprehensive health services including cardiac surgery, general surgery, neurosurgery, cancer treatment, mental health services, orthopedic surgery, a renowned NICU and pediatric center, and other treatments.

The formal name for the government agency that governs the hospital is Kaweah Delta Health Care District and it is overseen by a five-member board of directors that is elected by the voters that live in the district.

Who knew this? What do you think about a hospital being owned by the taxpayers?

[SHOW SLIDE]

- 5) Voters who live within the boundaries of this map elect the Kaweah Delta Health Care District board members and pay taxes to the Health Care District, but anyone can be a patient at the hospital regardless of where they live. What do you think about the map? What do you think about anyone being able to seek care at Kaweah Delta?



Probolsky Research
100 Pine Street Suite 1250
San Francisco CA 94111

San Francisco (415) 870-8150
Newport Beach (949) 855-6400
Washington DC (202) 559-0270

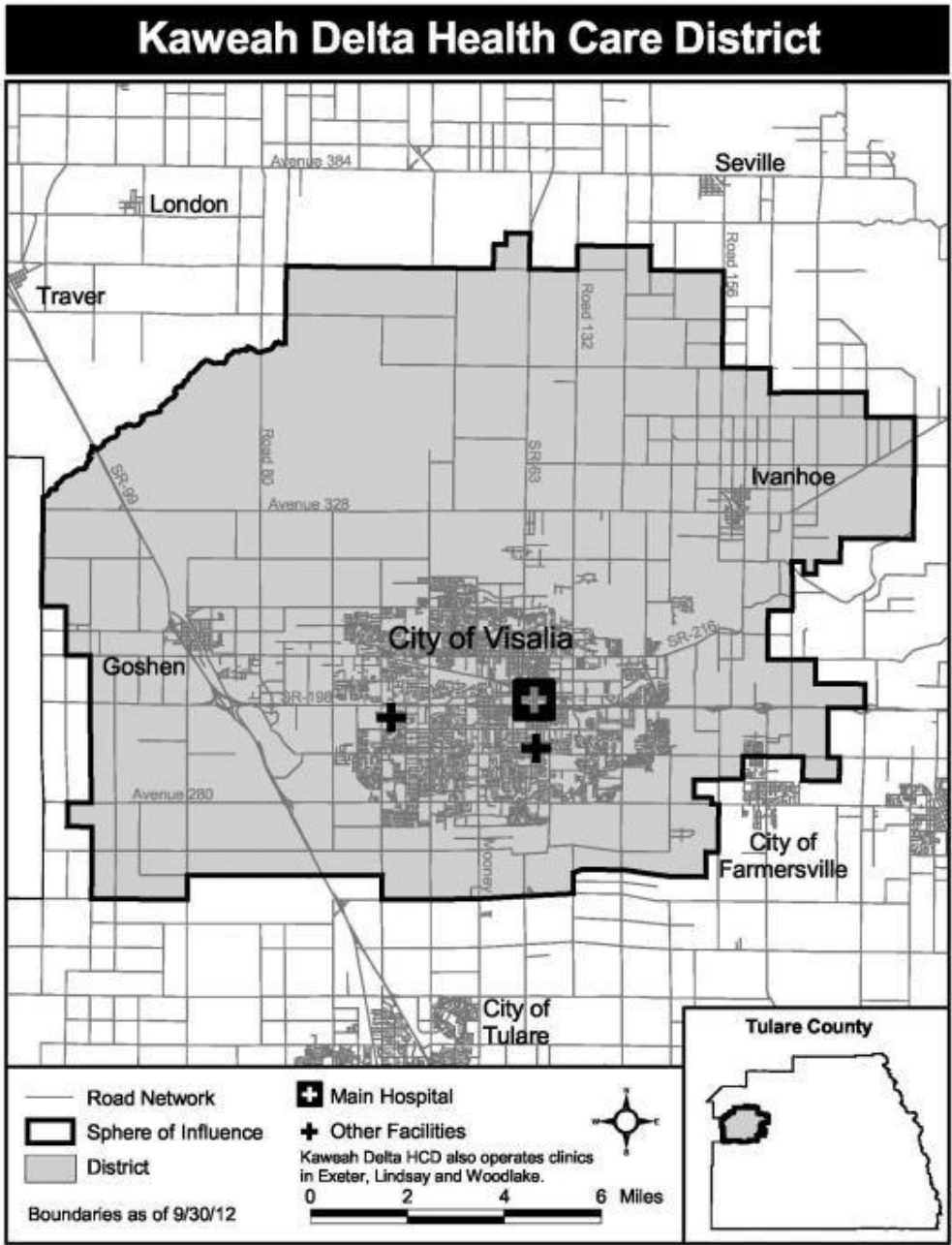

6) Do you trust Kaweah Delta? The medical care they provide, the leadership to tell the truth, to always consider the best interest of the community in how they operate?



Probolsky Research
100 Pine Street Suite 1250
San Francisco CA 94111

San Francisco (415) 870-8150
Newport Beach (949) 855-6400
Washington DC (202) 559-0270

- 7) Who would you trust the most to tell you about the future of the hospital, a doctor, a nurse, or hospital administrator/CEO, a health care district board member? Someone else? Why?
- 8) Do you think Kaweah Delta is just a small-town hospital you go to because its close or a hospital you choose to go to for complex care?
- 9) Kaweah Delta is affiliated with the Cleveland Clinic for cardiac care, which has the No. 1 ranking heart program in the nation. Kaweah Delta is the only hospital in California that Cleveland Clinic affiliates with. How does knowing this make you feel about getting cardiovascular/or heart care at Kaweah Delta?
- 10) Please tell me why it's important to you that Kaweah Delta has the financial and medical resources to provide great quality care.

Improvement

- 11) Are you aware of any improvements that need to be made to Kaweah Delta facilities? How about improved parking?
- 12) The Mineral King wing of Kaweah Delta was built over 50 years ago, before there were PCs, mobile phones, and before we landed on the moon, in 1969, and has not been significantly updated since. This wing contains 206 of the 435 beds Kaweah Delta has on the downtown campus. There is a need for a more modern facility to better serve patients, and the Mineral King Wing does not comply with state earthquake standards beyond 2030 and will need to be replaced.

Kaweah Delta is in the planning stages to build a new modern hospital wing. Do you support or oppose a new hospital wing being built? Why? Why not?

[IF TOPIC COMES UP]

It would cost approximately \$200 million to retrofit the Mineral King wing with large support structures on the outside of the building for earthquake safety but they would



Probolsky Research
 100 Pine Street Suite 1250
 San Francisco CA 94111

San Francisco (415) 870-8150
 Newport Beach (949) 855-6400
 Washington DC (202) 559-0270

lose rooms in the process and would have to close the hospital during the potentially multi-year construction process... it really is not feasible.

The Mineral King wing would be repurposed for use as offices or perhaps a skilled nursing facility. Whatever the highest and best used allowed by law.

13) What does modernize mean to you when thinking about a hospital?

Looking back to the failed 2016 Bond Measure

14) In 2016, Measure H, a general obligation bond measure, failed to get enough support from voters. What do you know about Measure H?

15) [SHOW SLIDE]

In 2016 Voters Rejected Measure H

Measure H-

To provide life-saving emergency and medical care from newborns to seniors, to expand facilities for rapid treatment of trauma, heart attacks, and strokes, to improve facilities for treatment of cancer, diabetes and other diseases, to replace patient areas not meeting earthquake safety standards required by California law, to attract doctors, nurses and medical specialists to our community, shall Kaweah Delta Health Care District issue \$327,000,000 in bonds to improve critical care and essential hospital facilities?

To fund the repayment of these bonds, Measure H would have authorized a parcel tax of \$48.70 per year per \$100,000 assessed valuation on property.

[NOTE: Was \$550M with community paying for \$327M.]

16) Why do you think the bond measure failed in 2016?

17) Can you think of any of the arguments you heard against Measure H?



Probolsky Research
100 Pine Street Suite 1250
San Francisco CA 94111

San Francisco (415) 870-8150
Newport Beach (949) 855-6400
Washington DC (202) 559-0270

- 18) Can you think of any of the arguments you heard in support of Measure H?
- 19) Measure H or any future bond measure would only raise some of the money necessary to fund the cost of major hospital modernization and new construction. Kaweah Delta would raise other funds from hospital revenues, other loans, and grants. Does this make sense? Is it a good plan? Do you think there is any other way to accomplish the goal of having facilities to deliver high-quality healthcare?
- 20) After the failure of Measure H, Kaweah Delta committed to transparency and education and formed a Community Engagement Initiative. This initiative included ambassador groups, advisory groups, and public forums such as town halls and webinars. The initial goal was to involve community members in the planning of future facilities, to listen to feedback and concerns from the community, and to involve others in important measures to help build trust. More than 200 community members have participated in these community engagement groups. Do you feel like Kaweah Delta has done a good job expanding their outreach and trust in the community through social media, town halls, and virtual public forums?

Master Plan

[SHOW SLIDE]

To develop a plan for replacing the Mineral King building, Kaweah Delta conducted an open and transparent public bidding process, and with input from the community members, they hired RBB as its architect. They were selected for their track record of building lower cost hospitals that are highly efficient — including a similar sized hospital in Merced. RBB has worked with Kaweah Delta leadership and consultants to create a facility plan to meet the community’s future healthcare facilities and technology needs. More than one dozen options for replacing the Mineral King wing were considered. The goal was to build a new wing to provide quality care for the next 50 years in the most affordable way. There are now two options being considered and Kaweah Delta is seeking additional feedback from the community before it decides between the two options.

Kaweah Delta, like any large organization, is always planning for the future. Let’s talk about hospital beds and hospital rooms.

[SHOW SLIDE]



Probolsky Research
 100 Pine Street Suite 1250
 San Francisco CA 94111

San Francisco (415) 870-8150
 Newport Beach (949) 855-6400
 Washington DC (202) 559-0270

21) Let's look at some images of patient hospital rooms. The current patient rooms in the Mineral King Wing are pie shaped and not conducive to a positive patient experience. They are cramped at 118 square feet, lack space for visitors, and modern healthcare equipment. Patient beds are up against one wall which limits access to a patient and limits the number of staff who can help a patient.

The Acequia Wing patient rooms are a bit larger and safer at 149 square feet and has limited space for visiting family and modern medical equipment.

The proposed new wing patient rooms would be consistent with current best practices in hospital design, which includes larger rooms at 175 square feet, have a proper bathroom experience, room for medical equipment and safer overall and allow family members to stay overnight with their loved ones.



[SHOW SLIDE]

22) Now let's look at both options and their phases. Which one do you like more and why?

Option 1:



Probolsky Research
100 Pine Street Suite 1250
San Francisco CA 94111

San Francisco (415) 870-8150
Newport Beach (949) 855-6400
Washington DC (202) 559-0270

The first tower (Phase I) will be built and operated for several years before the plan for building the second tower (Phase II) is started. This option does give Kaweah Delta the flexibility as the community needs change. For example, they could build the second tower larger or smaller based on those needs.

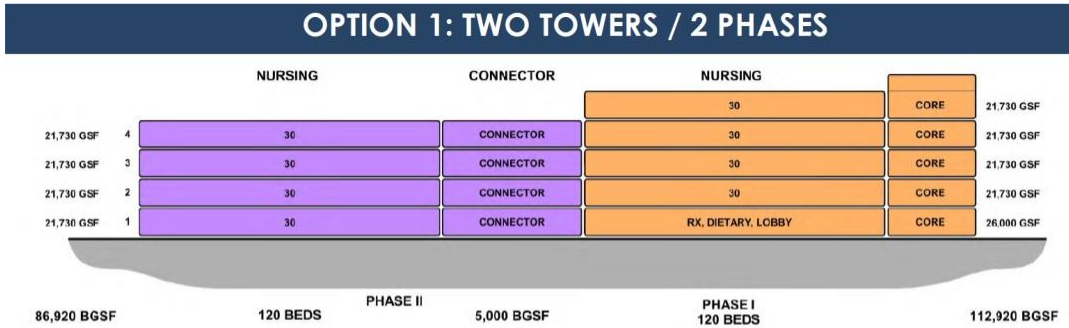

- Phase 1** : 5-Storeys, 120 beds, Pharmacy, Dietary, Lobby, 452-car Parking Structure
 : Construction Start mid 2026 - Completion by January 2030
 : \$318.5 Million (\$231 M 2020 cost + 4.5% yearly escalation to 2027 mid-point of construction+ EIR)
- Phase 2** : 4-storeys, 120 beds, 348-car Parking Structure
 : Construction Start 2036 - Completion by January 2040
 : \$365 Million (\$170 M 2020 cost + 4.5% yearly escalation to 2037 mid-point of construction + EIR)



Option 2:
 This tower would be built at one time, but the top four floors would be shells and the hospital would later build them out floor by floor as needed.



Probolsky Research
 100 Pine Street Suite 1250
 San Francisco CA 94111

San Francisco (415) 870-8150
 Newport Beach (949) 855-6400
 Washington DC (202) 559-0270

OPTION 2: ONE TOWER / 2 PHASES

21,730 GSF	9	SHELL	CORE	30
21,730 GSF	8	SHELL	CORE	30
21,730 GSF	7	SHELL	CORE	30
21,730 GSF	6	SHELL	CORE	30
21,730 GSF	5	BED	CORE	30
21,730 GSF	4	BED	CORE	30
21,730 GSF	3	BED	CORE	30
21,730 GSF	2	BED	CORE	30
26,000 GSF	1	RX, DIETARY, LOBBY		CORE
				PHASE I
				120 BEDS
				PHASE II
				120 BEDS
				FILLED SHELL
199,840 BGSF				

Phase 1 : 9-Storays (4 shelled), 120 beds, Pharmacy, Dietary, Lobby, 500-car Parking Structure
 : Construction Start mid 2026 - Completion by January 2030
 : \$440 Million (\$319 M 2020 cost + 4.5% yearly escalation to 2027 mid-point of construction + EIR)

Phase 2 : Infill 4-storays, 120 beds
 : Construction Start 2036 (tentative) - Completion January 2040
 : \$101.5 Million (\$48 M 2020 cost + 4.5% yearly escalation to 2037 mid-point of construction)

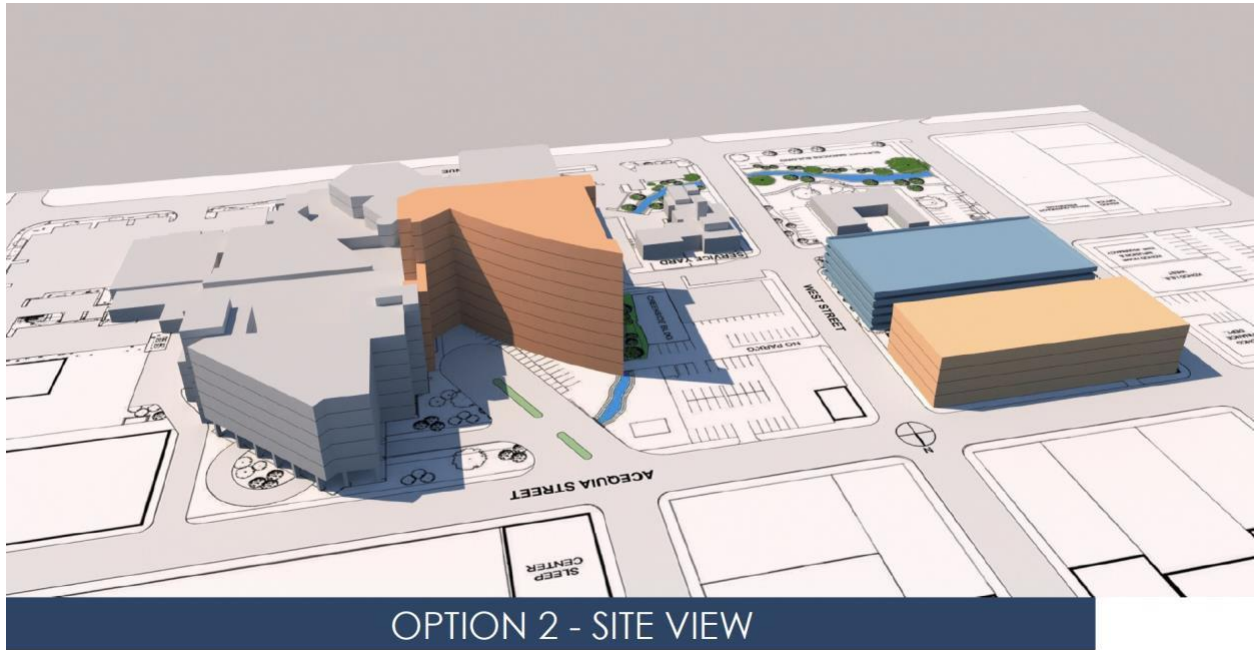

OPTION 2 - SITE VIEW



Probolsky Research
 100 Pine Street Suite 1250
 San Francisco CA 94111

San Francisco (415) 870-8150
 Newport Beach (949) 855-6400
 Washington DC (202) 559-0270

Bond Measure — Future

23) Paying for all the needed new or updated hospital facilities could cost as much as \$500 million or more. Kaweah Delta does not have all the money to pay for this and would need to raise a portion of the funds through a bond measure. As a public hospital, Kaweah Delta treats all patients regardless of their insurance or their ability to pay for services. Tulare County is among the poorest counties in California and has the highest percentage of patients covered by Medi-Cal, which pays hospitals the lowest rates. As a result, Kaweah Delta is paid much less than most hospitals in the state.

24) Would you support or oppose a bond measure to pay for the updates needed? Why or why not? If not (or if you are not sure), what additional information would you like to see from Kaweah Delta to help you make up your mind?

25) What do you think about the idea of a bond measure? How do you think a bond for Kaweah Delta would impact you? What about timing, should it come before voters in the next couple of years or later like 5-6 years from now?

>>>Internal note: 50/50 is the goal but not guaranteed.

26) In option one with two towers, it will cost approximately \$684 million dollars to fund hospital updates and new facilities. This would be \$319 million for Phase I and \$365 million for Phase II. Kaweah Delta would work with banks and other institutions to borrow as much money as it can to fund this project. Assuming that Kaweah Delta could borrow half of the money, Kaweah Delta would pay for \$160 million and taxpayers would be asked to pay for \$159 million for Phase I. Then, a few years later when Phase II is started, Kaweah Delta would pay for an additional \$183 million, and taxpayers would pay for the other \$182 million. The total of the two bonds that taxpayers would be asked to repay would be approximately \$342 million. An average property owner would pay an additional tax of \$35.55 per year for every \$100,000 of assessed value (rates vary per year with the first year being \$17.30 per \$100,000 and the highest year being \$67.70 per \$100,000). For thirty years. So, for a \$400,000 house, the homeowner would pay approximately \$142.20 per year. (This number is based on the average amount of \$35.55 per \$100,000 assessed value.) Do you think this is reasonable? Would be willing to support this? Why or why not?

27) In option 2 with one tower, it would cost approximately \$542 million to fund hospital updates and new facilities. Kaweah Delta would borrow as much as it can to fund this



Probolsky Research
100 Pine Street Suite 1250
San Francisco CA 94111

San Francisco (415) 870-8150
Newport Beach (949) 855-6400
Washington DC (202) 559-0270

project. Assuming, again, that Kaweah Delta would borrow half of the project cost, Kaweah Delta would pay for \$220 million and taxpayers would be asked to pay for \$220 million for Phase I. Then, a few years later when Phase II is started, Kaweah Delta would pay for an additional \$51 million, and taxpayers would pay for the other \$50 million. The total of the two bonds that taxpayers could be asked to repay would be approximately \$270 million. An average property owner would pay an additional tax of approximately \$31.93 per year for every \$100,000 of assessed value (rates vary per year with the first year being \$25.56 per \$100,000 and the highest year being \$62.15 per \$100,000). For thirty years. So, for a \$400,000 house, the homeowner would pay approximately \$127.72 per year. (This number is based on the average amount of \$31.93 per \$100,000 assessed value.) Do you think this is reasonable? Would be willing to support this? Why or why not?

[SHOW SLIDE]

28) Kaweah Delta has revenues of \$734M a year and the health care district receives \$1.2 million in property taxes and \$3.1 million to pay back Measure M bonds (passed in 2003) from property owners. By example, it costs \$1.8 million a day to operate Kaweah Delta. And the District has approximately \$60 million in COVID-19 related losses. The District has reserves totaling approximately \$316 million (about 176 days of operating capital). The District has resources to provide world-class patient care and maintain and make modest improvements to facilities. The District does not however have the resources to build a new hospital, which is needed, that would cost hundreds of millions of dollars. Does this make sense? What do you think about all that?

29) Kaweah Delta is going to pay for a large portion of the new hospital wing from revenues and other sources like grants and other loans. How does this make you feel?

30) OK, now imagine you are the advertising genius that has to come up with the ads about the hospital bond. What would you put in the ads? Imagery? Words? How would you explain it to your neighbors and the broader public?

District Residents

31) How do you feel about people who use hospital facilities but do not live within the health care district?



Probolsky Research
100 Pine Street Suite 1250
San Francisco CA 94111

San Francisco (415) 870-8150
Newport Beach (949) 855-6400
Washington DC (202) 559-0270

32) Much of the advanced care available at Kaweah Delta (open heart surgery, neurosurgery, cancer care, etc.) would not be available at Kaweah Delta if the hospital didn't serve patients from outside the health care district. When people from outside the district seek care at Kaweah Delta, the bills they pay help to support additional services at the hospital. Does this change the way you feel about them being able to access care at Kaweah Delta?

33) Kaweah Delta has met with surrounding healthcare districts that do not have hospitals to discuss merging healthcare districts or evaluating options that would allow the other districts to help support Kaweah Delta's building of a replacement facility. How do you feel about other health care districts consolidating with Kaweah Delta? What concerns do you have if this happened? Would this change your feelings about people outside of the Kaweah Delta Health Care District receiving care at Kaweah Delta. How about your support for a new bond?



Probolsky Research
100 Pine Street Suite 1250
San Francisco CA 94111

San Francisco (415) 870-8150
Newport Beach (949) 855-6400
Washington DC (202) 559-0270

Appendix B: Transcript

Group 1

Adam: Good evening. Welcome to our discussion group. Thanks for taking the time to join us. My name is Adam Probolsky. I own a research company here in California and I am based in Orange County. That is what you see behind me actually, is Orange County Airport, John Wayne Airport. So we are discussing healthcare and actually we don't always necessarily, well, we'll get into the details, but it's going to be healthcare locally and you were qualified and we brought you in because you live in Tulare County. That's kind of the sum total of your qualifications. It's a little bit more finer point and we'll get into that in a couple of minutes when I show you a map and stuff like that. So this is just for research purposes. Nobody's going to sell you anything. No one will definitely in any way follow up with you. Definitely available afterwards for questions, but this is just a one time trying to understand what your thoughts are on the subject matter.

Adam: [REDACTED]

Adam: Sorry for the interruption folks. Hopefully he... Let's see... All right, that's not working. All right. So we'll just kind of keep going. I'll let [inaudible 00:02:31] dealing with, oh, there we go. iPad four, what's your name?

[REDACTED] [REDACTED]

Adam: [REDACTED]

[REDACTED] Yes.

Adam: All right, [REDACTED] we're a first name only basis. I just put you as [REDACTED]. That's great. Meet everybody else. I'm Adam Probolsky. I'm just kind of going through the list of a little bit of ground rules. Only one person is speaking at a time. Please address all comments towards me. No side conversations. No such thing as a wrong answer, just different



Probolsky Research
100 Pine Street Suite 1250
San Francisco CA 94111

San Francisco (415) 870-8150
Newport Beach (949) 855-6400
Washington DC (202) 559-0270

points of view. Feel free to share whatever's on your mind. Negative comments, positive comments, just fine. Just definitely don't want one person dominate the conversation. So I may move it along a little bit at times. If you disagree, say, hey, I disagree and here's why, or if you agree, I agree and here's why.

Adam: It's not my role to express my opinion, but I may bring up some ideas and see what you think about them at times. So as a quick warmup, let's go ahead and say your first name, how you like it to be said, and then in six seconds or less one factoid about you. I'll say I'm Adam Probolsky and I haven't been on a plane in 18 months. Why don't we go ahead with you [REDACTED]

[REDACTED] [REDACTED] and I live, I've been here in Tulare County since 1991.

Adam: All right. [REDACTED]

[REDACTED] [REDACTED]

Adam: Oh, congratulations [REDACTED]

[REDACTED] [REDACTED]. And I'm a retired for five years.

Adam: Awesome. [REDACTED]

[REDACTED] Hi, my name is [REDACTED] and I was born and raised in Visalia. [REDACTED]
[REDACTED]

Adam: Awesome. [REDACTED]

[REDACTED] [REDACTED]

Adam: [REDACTED]

[REDACTED] [REDACTED]

[REDACTED] [REDACTED]

[REDACTED] [REDACTED]

Adam: Awesome. All right, [REDACTED]



Probolsky Research
100 Pine Street Suite 1250
San Francisco CA 94111

San Francisco (415) 870-8150
Newport Beach (949) 855-6400
Washington DC (202) 559-0270

[REDACTED] [REDACTED] and I have a giant bookshelf somewhere behind me.

Adam: J [REDACTED]

[REDACTED] [REDACTED]

Adam: A [REDACTED]

[REDACTED] [REDACTED]

Adam: Awesome. [REDACTED]

[REDACTED] [REDACTED]

Adam: You cut out there [REDACTED]

[REDACTED] [REDACTED]

Adam: Great. All right, [REDACTED]

[REDACTED] Hi, my name is [REDACTED] I have lived in Visalia since 1998. My family has been in Tulare County since 1906, I guess.

Adam: All right. Very good, [REDACTED]

[REDACTED] Hi, my name is [REDACTED] I'm 31 old I've lived in Visalia my whole life [REDACTED]
[REDACTED]

Adam: Very cool. Awesome. Well, thanks everyone for being with us. We're going to kind of get right into it and we'll get a little more intel on what we're talking about. First, what do you know about Kaweah Delta? Anybody raise your hand and chime right in.

[REDACTED] My daughter was born there.

Adam: Very good.

[REDACTED] One of the only hospitals in our area.

[REDACTED] I was born there and it's one of the biggest hospitals serving in Tulare County.



Probolsky Research
100 Pine Street Suite 1250
San Francisco CA 94111

San Francisco (415) 870-8150
Newport Beach (949) 855-6400
Washington DC (202) 559-0270

█ They just had a name, change, Kaweah Medical.

█ There's a helipad.

Adam: That's good to know. So █ what do you know?

█ I would say I did not quit when I was in the hospital and that there's a bunch of clinics or things around the valley that are Kaweah based.

Adam: █ what do you know about Kaweah Delta?

█ Well, I had open heart surgery there once. And I've had probably several other surgeries. █

Adam: Anybody have anything specific that they like about Kaweah Delta?

█ Like everyone said, I delivered, I had my children both there. And growing up, I just remember when my mom was, she's diabetic. Immediately when she got sick, nope, let's not go to Tulare Hospital let's go Kaweah, because it always had that standard of level that I always just [inaudible 00:07:55] little hospitals we have in our area.

Adam: Anybody else? Something they like about Kaweah Delta?

█ I appreciate the fact [inaudible 00:08:07] individual rooms as opposed to shared rooms. I believe all of the rooms are individual, actually.

█ [crosstalk 00:08:17] Oh, go ahead. I'm sorry.

█ No, that's a good thing. That's all I was going to say was. Yes, it's nice to have a single room when it's, when you have a loved one there or being there yourself. It's nice.

Adam: █ what were you going to say?

█ I was just going to say recently, well, over the last, five to 10 years, they've been expanding a lot and a new building and moving the delivery rooms and stuff into the newer building. So it's nice to have more space.

Adam: Go ahead.



Probolsky Research
100 Pine Street Suite 1250
San Francisco CA 94111

San Francisco (415) 870-8150
Newport Beach (949) 855-6400
Washington DC (202) 559-0270

██████████ I would say that I've had not only myself but my husband and my mother have both received care there and the nursing care was excellent.

Adam: Good. Anything you don't like about Kaweah Delta?

██████████ I would say for me, I think the main thing, and I've only lived in Visalia for probably two years so it's still very new to me, but I think the one thing I've noticed with Kaweah Delta, and I've had very limited experience with them, nothing too bad, fairly well, but it seems very monopolized in that seem like they control the whole county. Which is weird because I grew up in ██████████ where in ██████████ they probably have about five or six hospitals. Very different options which some of them are kind of the same ones. So, I find it a little weird to have just [inaudible 00:09:41] it's just Kaweah Delta for the most part, especially in Visalia especially on the other clinics and stuff like that. But you can't say too many bad things about them, but that was a little weird.

Adam: Anybody else have a concern over the perception that there's a monopoly? Anyone else agree with that statement?

██████████ I don't necessarily know about monopoly, but I do know that the board, the higher up people can be somewhat elitist as well as to move up within there, you kind of need to know them and be on their good side. ██████████
██████████ So I'm kind of familiar with the board thing.

Adam: All right. Well, great. So I'm going to go ahead and share my screen and show you some words. So go ahead and read that and then we will discuss it right after. I'll give you a minute or so to read through it. Everybody, you should get a chance to see that. All right. Give me something that surprises you, shocks you, amazes you or interests you.

██████████ Well, there's not much there I didn't already know. I had a friend who had a baby that was in the NICU and they got just very, just excellent care and the little baby eventually passed away but it wasn't due to their care at all. They received very good care. I am kind of surprised that they only have a five member board of directors. I would think that the board of directors there would be more than five, but that's about the only thing that I'm was not pretty aware of.

Adam: Anything interesting, concerning, shocking, ██████████?



Probolsky Research
100 Pine Street Suite 1250
San Francisco CA 94111

San Francisco (415) 870-8150
Newport Beach (949) 855-6400
Washington DC (202) 559-0270

█ Like I mentioned before, I think the one thing is being the only local hospital. It's cool to see all the different as I'm still new to the area still learning a lot of different stuff about the hospital, all the different services, they cover, departments, stuff like that. That's good, obviously. Obviously with them being the only option, I think it's, hopefully they would have all those different options for.

Adam: Raise your hand, if you feel like you generally knew this information. So keep your hand up one, two, three, four, five, six, seven. All right. █ anything interesting, shocking, revealed?

█ No.

Adam: █

█ Not really. I don't know too much about administration, but the five member board of directors, I'm not sure that's normal for how big Kaweah Delta is or if there should be more. But other than that, everything else doesn't really stick out to me.

Adam: █ how about you?

█ Basically, just to piggyback on everybody else. I kind of knew most of this, except I didn't know about the five member board of directors and how that, how they're elected here. I didn't know that. It does seem a little odd how there's five people in control of such a big hospital. And just kind of what █ was saying about how it's kind of only located here in Visalia, I think that's probably just as Tulare county isn't really that huge unless the biggest city here in the county. Maybe if you just go a little further north you'll find Fresno and they're massive hospitals. But still five people in charge of making decisions out of this big hospital. That's kind of shocking and interesting.

Adam: █ What interesting, shocking, exciting, what from what you read?

█ I guess that there's a government agency that governs the hospital. I didn't know that there was its own entity. I thought all hospitals have, governed by the state or the county or something.

Adam: █ what's interesting to you about what you read?

█ I would say seeing kind of the general numbers to kind of give an idea of the logistics behind Kaweah and how many people work for them and how many, just how big they are within just here and in retrospect, without doubt, the central valley.



Probolsky Research
100 Pine Street Suite 1250
San Francisco CA 94111

San Francisco (415) 870-8150
Newport Beach (949) 855-6400
Washington DC (202) 559-0270

Adam: [REDACTED]

[REDACTED] Well, the 5,100 employees, if we have 150,000 people or so in Visalia, that's 3% of the population that works for Kaweah Delta. So it definitely plays a huge role probably in the whole county, the whole area of the economy, things like that.

Adam: [REDACTED] anything new you learned or good, bad from this information?

[REDACTED] Well, Kaweah Delta has a structural problem that they've been wrestling with for years. Basically, the fact that it's a district hospital, meaning that it covers a certain territory and it has required to serve that territory. And there's a tax issue here that I'm not sure I'm familiar with enough.

Adam: We'll get to that, Jim. Is there anything about this information here that was interesting or new?

[REDACTED] Oh, I'm sorry.

Adam: Is there anything about this that you were surprised by or interested in?

[REDACTED] No, I don't. I've been that's...

Adam: We'll definitely come back to what you were talking about. [REDACTED] anything interesting, shocking, surprising, exciting?

[REDACTED] I'll just go ahead and piggyback on a couple other people talking about a 5,100 jobs. That's a pretty incredible [inaudible 00:16:57] level of employment here, especially since this is the area is known for its low employment levels.

Adam: And [REDACTED]

[REDACTED] Well, everything that I saw there, like everyone said, I knew. However something that I did not see on there that I just found out actually, yesterday my relative is a chemo dialysis patient and Kaweah Delta is the only hospital in Tulare County or health center that has an immune specialist. So that amazed me, that Kaweah was the only one. So I found that very interesting.

Adam: One thing that's just come up, a couple of people have mentioned it, this idea that Kaweah Delta is a major part of the economy or a big part of jobs in the county. Is that, how do you characterize that? Does that mean we got to, it's great that we have it, is it



Probolsky Research
100 Pine Street Suite 1250
San Francisco CA 94111

San Francisco (415) 870-8150
Newport Beach (949) 855-6400
Washington DC (202) 559-0270

we need to support it more? Is it a good thing that they're a big part of the economy is a scary thing that they're that big part of the economy? Any thoughts on that?

I think that like them playing such a big part is fine if that works for us, but it's not fine that the entire thing is only overseen by five people. And probably those five people all belong to the same sort of demographic. I feel like because it does play such a huge role it should be a larger and more diverse pool of people because that would be representative of the county.

Adam: looks like you were agreeing. What were thinking there?

No, I definitely concur with everything that she just said it. I think it's fine. I think it's actually fantastic that we have employed this many people in the valley and [inaudible 00:18:52], or in the county, and they serves our people here. That's great. But five people in control have that much power? And if especially if they're of the same demographic as she pointed out, that's probably an issue.

Adam: Any other thoughts on the role that Kaweah Delta plays in the economy? All right. We're going to move to the next slide and I'll show you, this is the boundaries of the health care district. This is so voters who live within this district, within the boundaries, elect the board of directors, the district board members. The people that live within these boundaries also pay taxes to the healthcare district. But anyone from anywhere quite frankly, can be a patient just like in any hospital. If you show up, they're going to treat you, regardless of where you live. Any thoughts about this map? Anything interesting about this map or about what I just said?

: Are the squares like the sections of voters or is that just like the streets of Visalia?

Adam: Just the streets. So this is just the map here. And then outside the map, because obviously it's not within the district itself. Yeah?

I thought Farmersville was part of the district. That was, that's a little different, that's something I did not know.

Adam: All right. And I don't want to dwell on it, but the most city councils have, let's say, five members or seven members and the county board of supervisors typically has five or so members. Anybody have a number of how many board members do you think there should be for a, or in the water district typically has five board members. Anybody think, have an idea of like how many board members there should be?



Probolsky Research
100 Pine Street Suite 1250
San Francisco CA 94111

San Francisco (415) 870-8150
Newport Beach (949) 855-6400
Washington DC (202) 559-0270

█ I don't know. I would just think more. Maybe 10 agents, I don't think any more than that. But [inaudible 00:21:07] it's got to be an odd number, I guess, probably.

Adam: All right. All right.

█ I have a question. Really quick, just because I don't understand how these districts work that you're showing on here, but would that be because another facility or other clinic is taking over in Farmersville?

Adam: There are other healthcare districts that have different kinds of services. It's government political subdivisions are not, they're kind of weird, right? They're drawn by lines that based on history, based on all kinds of different things. But this is the boundaries of the district. █, you were saying something?

█ I think the one thing for me that I'd be curious to know what the five board members what's the term length and how often those get.

Adam: Those are four years, but we can talk about more about that later. Do you trust Kaweah Delta, the medical care they provide, the leadership to tell the truth, to always consider the best interest of the community, and how they operate? Do you generally trust Kaweah Delta. █ You're you're on mute, █ you got to get yourself off of mute. All right, well, we'll come back to █ do you generally tru-, oh █, there you are. Do you generally trust Kaweah Delta and their leadership, the medical care and them to tell the truth, do the right thing?

█ Well, yeah, I do. I think they do an excellent job. It's a situation where there are some problems and-

Adam: But do you trust them though?

█ Do I trust them? Yeah, I trust them, sure. Lorraine, do you trust them?

█ I don't have any reason not to. Other than when it comes to bureaucratic things, there's always going to be something messy involved, but I'm so far down the totem pole that there's no reason why I shouldn't trust them.

Adam: Alisa, do you trust the leadership to tell the truth, provide good medical care?

█ The leadership to tell the truth you said?



Probolsky Research
100 Pine Street Suite 1250
San Francisco CA 94111

San Francisco (415) 870-8150
Newport Beach (949) 855-6400
Washington DC (202) 559-0270

Adam: Yeah.

█ The supervisors? Because I was separating the staff, the healthcare staff there.

Adam: Just in general as an entity. Do you trust Kaweah Delta from the leadership to generally to provide quality care, to tell the truth, to always have the community in mind as an organization? Do you trust them?

█ Yes. █

█ Yeah. I don't see a reason not to.

Adam: █

█ I trust the product there. I have no reason I say right now not trust the leadership but I haven't heard anything about it. Unless something changes, right. Because leadership can change at any time and that confidence [inaudible 00:24:31] to be the lost.

Adam: █ do you trust Kaweah Delta, the leadership to tell the truth, to provide quality medical care of the community, best interest in mind?

█ Personally, I don't think I would. Just because I am kind of familiar with people rewards there. People who have been higher up there as well. I have heard things about them not fully reporting statistics or how, if you have like a more serious condition you're not necessarily taken care of in the right way. So I think it's yes and no. Yes. I would go there, if I had food poisoning, but no, I would not go there for brain surgery.

Adam: █ do you generally trust Kaweah Delta?

█ I generally trust them, yes.

Adam: █

█ I agree with █ actually because I've heard some stuff. I work in healthcare and I've heard things that have happened at Kaweah Delta. And to some degree I would trust them but I'm not fully, especially administration when it comes to the higher ups.

Adam: All right. █, do you generally trust Kaweah Delta?



Probolsky Research
100 Pine Street Suite 1250
San Francisco CA 94111

San Francisco (415) 870-8150
Newport Beach (949) 855-6400
Washington DC (202) 559-0270

█ For medical care I think I, yeah, I would trust them. I don't have any reason to. But generally for me, I personally just don't trust these really powerful institutions. I feel often gets really muddled. The truth can get muddled, but that's where I feel, that's where I stand.

Adam: █ you generally Kaweah Delta?

█ Yeah. I've in the short time I've had no other reason to question them. Like the others, I don't know a lot of details when it comes to admin, stuff like that. But for as healthcare purposes, in my experiences, they've taken care of me. And so until otherwise, I do at this point, I do trust them.

Adam: █ how about you?

█ Generally speaking, yes, I do trust them.

Adam: So who would you trust the most to tell you about the future of the hospital? They were making big changes in the hospital, physically. Would you trust a doctor, a nurse, an administrator, the CEO of the hospital, a board member? Just tell me who you think like the authority would be that you think would trust the most to tell you, hey, here's what you need to do? Here's what we're trying to accomplish. What do you think? █ who would you want to listen to, hear from information from?

█ Well, if I wanted information from a CEO, I would go to them for what needs to be changed. But then in regards to the real truth, I would probably speak to a nurse because they're going to tell you what's going on behind the curtain.

Adam: █ who would you trust to tell you about the hospital, future of the hospital? A doctor, CEO of the hospital, board member, nurse, somebody else?

█ Well, I think it depends on what kind of information you're looking for and things change a lot. For example, the leadership of the hospital has changed in the last couple of years substantially. The one thing that, one other factor that comes in here, is that there is some state control over some of this.

Adam: So would you trust a state legislator or a state regulator?

█ Well, no, I'm talking more about the requirements of law that the state-



Probolsky Research
100 Pine Street Suite 1250
San Francisco CA 94111

San Francisco (415) 870-8150
Newport Beach (949) 855-6400
Washington DC (202) 559-0270

Adam: Right, so just thinking about who you would trust to tell you about the future of the hospital, who would that be? What's that kind of person?

Well, I had an awfully good heart surgeon, but I understand he's not there anymore and I'm not quite sure why. So like I say, it's hard to say who I would trust.

Adam: All right. who would you trust? Doctor, the media, the nurse, board member, who would you trust about the future of the hospital?

I don't know how to answer that. The future-

Adam: If you had to choose one person, one position, one job title, what would it be?

The nurse. They're the more blunt and won't be political, I guess.

Adam: All right. the CEO, the nurse, the doctor, the reporter. Who would you trust to tell you about the future of the hospital?

Probably definitely the nurse, because especially if the issues are lying within a hierarchal type of thing. I would feel I would get the most truthful answers from someone at the bottom.

Adam: who would you trust to tell you about the future of the hospital?

I kind agree with everyone else. I would ask someone like a nurse or doctors, people that are on the ground floor and they kind of know more about the what's actually going-

... on the ground floor in the kind of... No more above what's actually going on behind the scenes. Whereas if I can go to someone in leadership, they're going to give me a political answer, and I can't trust that.

Adam: what do you think? Who would you trust?

Probably a nurse or a doctor as well. They're the backbone of the hospital, they're the ones that are there all the time working hard for everybody else. And probably know more about it and be more open and honest about it than other people would.

Adam: All right. who would you trust about the future of the hospital?



Probolsky Research
100 Pine Street Suite 1250
San Francisco CA 94111

San Francisco (415) 870-8150
Newport Beach (949) 855-6400
Washington DC (202) 559-0270

Medical personnel, a doctor, a nurse. I feel like they would be way more honest, as opposed to the leadership positions where they're loyal to their job and it often gets really politicized, so they just wouldn't give you the truth.

Adam: Okay. [REDACTED]

[REDACTED] I would say a doctor, they're in between nurses and administration. So I feel like they would have more of an idea of what's going on, they would have more knowledge.

Adam: Okay. [REDACTED] who would you trust?

[REDACTED] Well, it's very interesting to hear everybody's opinion. But if you really want to know what the future of the hospital is, and where they're going and... I think that I would be asking the CFO. Because he's the one that's got the purse strings, and he knows what the directions are, and where the hospital is... What the plans are for the future. And the doctors and the nurses, they have not a clue as to what is going on within the hospital's administration. They want to give patient care, they care about their patients, and that's primarily their focus. So, as far as where the hospital is leading, and what their plans are for the future, I would say that if you want information you go to the CFO.

Adam: Okay. [REDACTED] Who'd you trust?

[REDACTED] Yeah, I think there's a couple different spots. I'm kind of leaning towards more at the top, whether it be like [REDACTED] said, CFO, chief of staff, or the CEO or board members. I think if you're going to be talking about the hospital's future and what's going on? Obviously they have control of it, I want to hear from them what's going on, whether it's a bad decision or what it is, they're the faces and they're making the decisions. So I think they need to be showing their face out there, and if they're making a bad decision then they're going to be the ones that are thrown under the bus if something's going wrong, or what's going on. So, I want to make sure that whatever decision they're making on the future of the hospital, whether it's good or bad, they're the face of it. And they're the ones up for reelection, so I want to know who is making those decisions, and who's going along with it.

Adam: All right. [REDACTED] how about you, who would you trust?

[REDACTED] Yeah, [crosstalk 00:33:00] I agree with [REDACTED] You're going to want to talk to the board members, the CFO, the people in control of the purse strings. They're the ones that are



Probolsky Research
100 Pine Street Suite 1250
San Francisco CA 94111

San Francisco (415) 870-8150
Newport Beach (949) 855-6400
Washington DC (202) 559-0270

planning and doing the advance work on where the district is going. You always want to know what's going on on the ground, talk to the nurses and the doctors. But I agree with [REDACTED], what [REDACTED] was saying. They're focused on patient care. But if you're looking for the direction of the hospital yeah, you want to talk to the board of directors, the CFO, the-

Adam: All right. So, I'm going to give you two positions and you're going to choose one. I'll read them both and then you guys can raise your hand, and for one or the other one I tell you. Do you think Kaweah Delta is just a small-town hospital that you go to because it's close? Or is it a hospital that you choose to go to for complex care, because you want to go there? So who says, "Kaweah Delta is just a small-town hospital you go to because it's close?" Raise your hand. One, two, three, four, five, six, seven.

Adam: And who says, "Kaweah Delta is the hospital you go to you choose for complex care"? One, two... [REDACTED] what's your thought on that one?

[REDACTED] Well, I think you go to it when there's reason. I do some things at Kaweah Delta, some things at clinics, and I've done things at hospitals in Fresno.

Adam: I get it, but you've got to choose one or the other. Is it just a small-town hospital you go to because it's there, it's close?

[REDACTED] No, it's beyond a small-town hospital.

Adam: Okay, so it's a place you choose for complex care?

[REDACTED] Right. You can do a lot... It's amazing to me how it's changed in the last... Since I've been here. 20 years.

Adam: Great, all right. So Kaweah Delta's affiliated with the Cleveland Clinic for Cardiac Care. Which is the number one ranked heart program in the nation. Kaweah Delta is the only hospital in California that Cleveland Clinic affiliates with. How does knowing this make you feel about getting cardiovascular heart care at Kaweah Delta? [REDACTED] any thoughts on that?

[REDACTED] Yeah, I did know that they were affiliated with a teaching hospital and cardiac care is what they... They really do excel there. And so I would definitely go there for cardiac care.



Probolsky Research
100 Pine Street Suite 1250
San Francisco CA 94111

San Francisco (415) 870-8150
Newport Beach (949) 855-6400
Washington DC (202) 559-0270

Adam: Raise your hand if you knew that Kaweah Delta was affiliated with the Cleveland Clinic? Yeah, one, two, three... Just three of you, okay. Any other thoughts on that affiliation, if that's very important to you, if it's moving to you, if it's-

Well, I think it speaks well to the hospital in general. And it's just good to know that they have the backing and the experience of a hospital like that.

Adam: Anybody else, thoughts on Cleveland Clinic affiliation?

I think it's great to hear that they're the only one in California. That's phenomenal to hear something like that, especially in our area. Do I have experience of that? No, but just hearing that, hopefully they're pushing that and publicizing stuff like that, because that's a great attribute to have for the hospital.

Adam: All right. We're going to talk about the financial position of the hospital. So, I'm going to make a statement, I'm going to look for your commentary. Tell me why it's important to you that Kaweah Delta has the financial and medical resources to provide great quality care. So, why is it important to you that Kaweah Delta has the financial and medical capabilities, resources to provide great quality care? Why is it personally important to you? ?

Well, I have family members that have these extra medical conditions and what not. So it matters that we have somewhere close by that can perform and give quality service to these medical conditions.

Adam: Okay. why is it personally important to you that the hospital at Kaweah Delta has financial and medical resources to provide high quality care?

I think it's important because it is the biggest hospital in this area, and this is what all the people in this area depend on. And it's also kind of a low-income community, and there are some very adversely-affected groups. So, I think that just because we do live in a more rural community that doesn't mean we shouldn't have access to that. So I think it is extremely important for them to have the financial resources to be able to provide back to us.

Adam: Okay. Anybody else can tell me why it's important the Kaweah Delta has the financial and medical resources to provide great quality care? [crosstalk 00:38:23]... important to you. Go ahead,



Probolsky Research
100 Pine Street Suite 1250
San Francisco CA 94111

San Francisco (415) 870-8150
Newport Beach (949) 855-6400
Washington DC (202) 559-0270

Well, one issue is that this being a rural facility, it's difficult to obtain quality physicians and healthcare professionals in the area. So having the resources to obtain the quality staff that they try to obtain is important so that the community does receive quality care.

Adam: Okay. Anybody else have a thought on why it's important to have... Yeah, go ahead,

For some years, Kaweah Delta had problems acquiring and keeping quality staff. And that doesn't seem to be such a big problem anymore. And then it's because they've really worked on it, and put some effort in it, and if you don't have a quality medical staff, you don't have a hospital.

Adam: Okay. All right, so let's go ahead and go into... Are you aware of any improvements that need to be made to Kaweah Delta facilities? Any thoughts on specific improvements to facilities they have? The buildings, the parking lots, the equipment, anybody have an idea of what... Yeah, go ahead

Well the ER has been... I think they're just now really moving into it. But for years the biggest complaint you heard from the public about Kaweah Delta was the ER. And you don't hear that so much anymore, because they worked on it, they've got better people running it. They have obviously expanded the facilities and it's a much bigger... I've spent Friday nights in the Kaweah Delta ER some years ago, and-

Adam: That was just for fun, or... Why were you hanging out on Friday nights at Kaweah Delta?

Well, I was there... I needed help!

Adam: All right, I get it! I thought it was just a reoccurring date or something?

And they were beautiful, they were great. But it was a mess. Because there were people all over the place, and... they had enough staff, but they didn't have the beds and that was a big problem.

Adam: All right. Anybody else know of a facility, something facility-wise that Kaweah Delta needs to upgrade or improve?

They've done a lot of improvements, over...

Adam: Currently, looking forward, anything that you know that needs to be fixed?



Probolsky Research
100 Pine Street Suite 1250
San Francisco CA 94111

San Francisco (415) 870-8150
Newport Beach (949) 855-6400
Washington DC (202) 559-0270

Nothing right now.

Adam: All right. So, the Mineral King Wing of Kaweah Delta was built over 50 years ago. Before there were personal computers, mobile phones, and before we landed on the Moon, in fact. It was in 1969, and it has not been significantly updated since. The wing contains 206 of the 435 beds Kaweah Delta has on the Downtown campus. There's a need for a modern facility to better serve patients, and the Mineral King Wing does not comply with state earthquake standards beyond 2030, and will need to be replaced.

Adam: Kaweah Delta is in the planning stages to build a new, modern hospital wing. In general, knowing that, do you support or oppose building a new hospital wing at Kaweah Delta? Why don't you go ahead and raise your hand if you support the idea of building... So we've got... Keep your hand up, one, two, three, four, five, six, seven, eight, nine, all right. Raise your hand if you oppose building a new hospital wing? I didn't see a hand from [REDACTED]. You've got to choose, support or oppose a hospital wing, what do you say?

I supported it.

Adam: Oh, okay. Did you? Okay. Who didn't have a hand up? [REDACTED] you didn't have a hand up, what do you say? Support or oppose?

Well I think that there are a lot of issues, here.

Adam: I know, but just [crosstalk 00:43:26]... We're getting into the details, but at the high level, do you generally support or oppose?

We have to do it, we have to have it. We have to have a bigger, better facility. There's no question about it.

Adam: Okay. So let's talk about modernize. What does modernize mean to you when you think about a hospital? Give me some ideas of what do you think modernizing means to you. [REDACTED]?

The interior, working on it. Also new tools that doctors, nurses may need so that they can work on the patients. Computers... What else? X-ray machines, MRIs, updating all that if they're outdated.

Adam: Okay. [REDACTED] what do you think modernize means when it comes to a hospital?



Probolsky Research
100 Pine Street Suite 1250
San Francisco CA 94111

San Francisco (415) 870-8150
Newport Beach (949) 855-6400
Washington DC (202) 559-0270

█ Besides obviously getting newer equipment I can speak as kind of a... As what I do as a █ is modernizing the way people can interact with their health data. [inaudible 00:44:34], digitizing any information they might have that is still on hard paper, and then making it easily accessible by anyone that needs to get that information. So you don't have to directly go whenever you need to, to get information from the hospital. You can just find that on your own.

Adam: Okay. █ what do you think of when you think of modernizing in the context of a hospital? What does that mean to you?

█ To me, I think state-of-the-art, of the most new research-type therapies are being offered to me. That's what I think modern. That they're trying new therapies [crosstalk 00:45:12]-

Adam: Say that again, █

█ Well no, just that, and then just more... They have more research therapies like new developing therapies that are probably not available, bring [inaudible 00:45:26] to here. I don't know if I'm making any sense, I guess I'll throw a random... I don't know. Maybe some kind of chronic disease that, "Oh, it's been researched in such place that this kind of therapy works with this. So, Kaweah Delta's going to be sponsoring that type of care."

Adam: Okay. █ what does modernization mean when you think of a hospital?

█: I think it mostly has to do with technology, putting everything onto one system, one database. But I also think it includes maybe opening up more resources that are more socially accepted, like psychiatry or women's health resources, things like that.

Adam: Okay. █ what do you think of when you think about modernizing a hospital?

█ Well, I have to agree with everybody in regards to technology and keeping the doctors and the nurses up to date on new research and new techniques. Also, the way that people are treated. That's... I don't know the word that I'm looking for, but yeah.

Adam: █ what do you think of when you think about modernizing a hospital?

█ Much the same as everybody else. Newer technology, medical supplies, equipment. I forget who said it, but he said that... having an online presence to connect with doctors and stuff? I think that's super relevant now with COVID. We can learn from that up-to-



Probolsky Research
100 Pine Street Suite 1250
San Francisco CA 94111

San Francisco (415) 870-8150
Newport Beach (949) 855-6400
Washington DC (202) 559-0270

code stuff. And then maybe some research centers, that's kind of what... Moving as we develop further.

Adam: [REDACTED] modernize, what does it mean to you?

[REDACTED] Yeah, I think getting back up to industry standards. Like you said, we're dealing with an older hospital, and so much has changed in the time that that hospital was built with the care facilities and so on like that. So, I think getting back up to what you're seeing in other hospitals around the United States, around the state, I know some have touched on before, it's getting a lot of that digital presence. Whether having so many different hospitals you can have that you can... Instead of going to the doctor's, you can just get on your iPad, do digital visits, and get stuff that you need there. So, having that accessibility to newer technology and things that are going on on those standards, that's what I would kind of hope that they're moving towards.

Adam: [REDACTED] what does modernize mean to you when it comes to a hospital?

[REDACTED] Yeah. Basically, technology, able to communicate with each other, and getting information that's necessary, and equipment. Having the proper, latest as much as they can afford equipment and supplies. Have everything that they need, basically.

Adam: Okay. [REDACTED], what does modernize mean to you, when it comes to a hospital?

[REDACTED] Well, modernization to me is updating with the digital world, and having better patient throughput, so that patients have better idea as to what the plans are, where they're going, when they're going? And being able to program when they're going for an X-ray, that they can just be pushing a button and finding out that they're scheduled for 10:15. So that it's a little bit more user-friendly. I'm sure that the nurses would have a tremendous input as far as what they would prefer, and computerized systems that all speak to each other, and minimize repetition.

Adam: [REDACTED] what does modernize, when it comes to a hospital, mean to you?

[REDACTED] I mean, everybody pretty much explained it. Technology for the most part, yeah.

Adam: All right. [REDACTED] what does modernize mean to you when it comes to a hospital?

[REDACTED] Well, it means better facilities and better staff.



Probolsky Research
100 Pine Street Suite 1250
San Francisco CA 94111

San Francisco (415) 870-8150
Newport Beach (949) 855-6400
Washington DC (202) 559-0270

Adam: Okay. All right. So, we're going to go to a little... The wayback machine. And talk about 2016. In 2016, Measure H was a general obligation bond measure. It was on the ballot before the voters, and it failed to get enough support from the voters to be successful. Raise your hand if you ever heard or have any understanding of Measure H. Okay, [REDACTED], all right. [REDACTED] what do you know about Measure H?

[REDACTED]: I don't remember, I just remember hearing about it, but I can't remember in detail what it was about.

Adam: All right. [REDACTED], what do you remember about Measure H?

[REDACTED] Exactly the same as [REDACTED]. I remember hearing about it, but I don't know what it was about.

Adam: [REDACTED] what do you remember about Measure H?

[REDACTED] Well I remember that one of the big issues had to do with taxes, who pays taxes for the district, and who uses the facilities. And this is this area's problem, because if you look at the map that was on the screen a little while ago, all of the area in white represents people who can use the facilities but don't pay taxes. And that's a serious problem.

Adam: Okay. We're going to go to look at some information about Measure H real quick, and then we'll talk about it. So go ahead and read this about Measure H, and we'll talk about it, take a minute.

Adam: This was the ballot question, I guess you could say, what you'd have seen on the ballot if you were voting in 2016. The information at the bottom wasn't exactly on the ballot, but it was explained.

Adam: Okay. Who has a sense of why you think Measure H failed? Anybody have an idea? Yes, [REDACTED] [crosstalk 00:52:22]? I'm sorry?

S [REDACTED] I think that people just don't want their taxes raised.

Adam: All right, good point. [REDACTED] you're agreeing, why do you think Measure H failed?

[REDACTED] I mean, that's when it comes down to a lot of different things, when it comes to is how much are people raising taxes, and what we're doing for... While I wasn't living here during this thing, but it's always a concern, because there was always different



Probolsky Research
100 Pine Street Suite 1250
San Francisco CA 94111

San Francisco (415) 870-8150
Newport Beach (949) 855-6400
Washington DC (202) 559-0270

measures going across that's raising taxes and so on. Well, with this one this is a very vital thing that needs update. Yeah, I can see why it failed.

Adam: All right. Thinking back [REDACTED] or anyone else, maybe it's jogging your memory, anybody remember hearing any messages supporting, promoting Measure H?

[REDACTED] A lot of promotion. At the time, I was working in a public job, and even within the county I just feel like they're promoting it more, even like on Government Plaza, and... That was just an observation at the time, when I was working with the county.

Adam: Okay. All right. [REDACTED] already brought up one message against it, anybody else remember hearing a message against Measure H?

[REDACTED] I actually have a question about this.

Adam: Yes?

[REDACTED] The last part, so does that mean if your house is worth \$100,000 then you paid \$50 in taxes per year?

Adam: Yeah.

[REDACTED] Oh, okay.

[REDACTED] Extra taxes.

Adam: Yeah, [crosstalk 00:53:54] measure. It was an additional tax. Okay. So let me take this, stop sharing... So, Measure H, or any future bond measure would only raise some of the money necessary to fund the cost of a hospital modernization and new construction. Kaweah Delta would raise the other funds from hospital revenues, loans, grants, other ways of raising money. Does this make sense, is it a good plan, do you think there's another way to accomplish the goal of having facilities that deliver high-quality healthcare? There's the possibility of raising new revenues through a vote-approved bond, and then the other half or so, give or take, monies, come from... Money comes into the hospital, they have revenues, so they can pay for some of it.

Adam: They can get grants from the federal government or the state, or foundations. Does that concept, does that generally jive with you? Or do you think, "No no, that's crazy. The voters shouldn't pay a dime." Or, "I don't think you can really fund it through revenues."



Probolsky Research
100 Pine Street Suite 1250
San Francisco CA 94111

San Francisco (415) 870-8150
Newport Beach (949) 855-6400
Washington DC (202) 559-0270

Anybody... That concept, money from a bond and money from other sources, does that make sense?

Yes, of course. I think.

Adam: Anybody think [crosstalk 00:55:16] it doesn't make sense? Oh, go ahead.

I think bonds are hard to get passed, because it's an extra tax. And everybody feels taxed to death in this state. So that's the tough part, but yeah, I mean there's a lot of sources of revenue, and they should explore every source.

Adam: So [redacted] just said, "There's a lot of sources of revenue, they should explore every source." Is that something... Raise your hand if that resonates with you, if you like that phrase, those words? Keep your hand up. One, two, three, four, five, six, seven, eight, okay. [redacted] does that phrase resonate with you? "They should explore every source of revenue, every source to run the hospital?"

Adam: [redacted] does that make sense to you?

Yeah. One of the issues is, who's going to pay the tax? Not only are the people... Is this a tax that's going to be paid by the people who use the hospital? Or-

Everybody in the district.

Adam: Yeah, [crosstalk 00:56:31] let's talk about that for a second. [redacted] brings up a point, and this was an argument that came up against H and... So, you've got the district, and that's the authority of the district is to tax people within those boundaries. But I live in Irvine, I could drive my way up to Kaweah Delta and show up at the hospital. When I'm done with my treatment, they just give me a bill, and I've got to pay it. If I don't pay it right, they can sue me. What's that?

Adam: Or there is the possibility that I'm on some federal or state assistance, and that the hospital would have some limited amount of monies for the treatment. Is that something that concerns you, this idea that only people within the district pay the tax, but the Irvine guy can come up and use the hospital. Is that concerning to anybody? Or the person just outside the district, right? Just two blocks' away and outside the district gets to use the hospital. Anybody concerned about that argument?

Of course.



Probolsky Research
100 Pine Street Suite 1250
San Francisco CA 94111

San Francisco (415) 870-8150
Newport Beach (949) 855-6400
Washington DC (202) 559-0270

Adam: Raise your hand if you're concerned that only people inside pay the tax, but anybody can use it. So, [REDACTED] why aren't you concerned about that?

[REDACTED] Well, because people outside of the district need help just like we do, and maybe there's not a hospital close to them and we're closer, or maybe we offer something that their hospital doesn't? I mean, we can't expect that only our district is allowed to use that hospital. It doesn't make sense to me.

[REDACTED] Well, I agree with that. I think they should be able to, or should find a way to... Like I said, some other source of revenues. Maybe it's a grant, maybe it's a... I wouldn't consider the idea of turning people away, ever. Because the same thing could happen, I could drive down to Irvine and show up at some hospital, and need care and expect to pay for it the same way I would here. But we have a huge trading area, and people will come from 40 miles to come into the hospital, and they may not be in the district and not be paying any taxes toward it. I don't think that should exclude anybody, but like I said, the same thing could happen to me. I could be in LA somewhere and end up at a hospital. I don't know the answer, but it's... Like I said, taxes. Everybody feels taxed to death.

Adam: Yeah. [REDACTED] are you concerned that people from outside the district could use the hospital but they don't have to pay the tax, the bond measure?

[REDACTED] Well, I mean we're in Tulare county, it's an under-poverished area. So the people that can pay the tax... I don't own a home, but I think if I... Yeah like [REDACTED] said, of course we don't want to be taxed. But I saw on the map, I think Traver and London were on there, and I'm not sure if anyone has driven there? But it's dead there. There's just nothing but farmland there. So of course, I think everyone should have access to healthcare. So I mean, if they have to pay the tax, okay, just [inaudible 00:59:58] cover everyone! I just can't imagine a hospital just saying, "Oh, we can't take you because..."

[REDACTED] I just can't imagine a hospital just saying, oh, we can't take it because of your zip code. That just, know...

Adam: Yeah, I don't think there's any expectation that the hospital would refuse care to people. I don't think they're allowed to. The question is, if there's going to be tax and only people within the district pay it. [REDACTED] brought this idea up that there's some people who say, "Well, I'm paying the tax, but you can use it." Even though you get a bill and all that sort of thing [REDACTED] what's your thoughts? Is there a deep rooted concern that, "Hey, it's



Probolsky Research
100 Pine Street Suite 1250
San Francisco CA 94111

San Francisco (415) 870-8150
Newport Beach (949) 855-6400
Washington DC (202) 559-0270

not fair that that people within the district have to pay the tax and yet anyone can use it." Is that a concern of yours?

Adam:

Oh, well, it is, but I think it's more of a political issue than anything else.

Adam:

Why's that?

The fact is that if Kaweah Delta is going to sell this bond issue. They're going to have to find a way to explain this to the people who live in the district. As to, "Why am I paying taxes on this bond, where other people who use the hospital aren't?" It's a tough issue. I don't have problem with it, but I think there's got to be a way to solve it. Now, a lot of discussion says, "Well, just to expand the size of the district." Why would anybody vote to join a district where they would have to pay taxes that they don't have to pay now for using the same facilities? This is the problem.

Adam:

Okay, fair enough. So after the failure of measure H, Kaweah Delta committed to realize, "Okay, we've got a challenge here. We still have a need." So they committed to transparency and education. They formed a community engagement initiative. The initiative included ambassador groups, advisory groups, public forums. There were town halls. There were webinars. The initial goal was to involve community members in the planning in the future the facilities. To listen, get feedback and concerns from the community and to involve others in the important measures to help build trust. About 200 community members have participated in these engagement groups. Do you feel like Kaweah Delta has done a good job expanding their outreach and the building trust in the community? They've done social media, town halls, virtual public forums. Anybody have a visceral... Raise your hand if you feel like they've done a good job with this transparency and outreach. Anybody want to raise your hand? Or you can say, "No".

Adam:

says, "Yes."

Adam:

says, "Yes."

Adam:

So one, two three, four, five. Okay. Anybody say they've done a poor job at transparency and outreach?

I wouldn't say it's poor, but I think they can definitely improve on it. You do see it out there, but obviously there're people here that, probably didn't see raise their hands.



Probolsky Research
100 Pine Street Suite 1250
San Francisco CA 94111

San Francisco (415) 870-8150
Newport Beach (949) 855-6400
Washington DC (202) 559-0270

Obviously they can do better. We want to make sure you're hitting all the outreaches, making sure everybody sees that visibility and what's going on.

Adam: All right. Let's go ahead and read this information and we'll talk about it in a minute.

Adam: Oh, all right. Good. Before I do share it, anyone know anyone who's been a member of any one of these committees, outreach, ambassador, anything having to do with Kaweah Delta? Anyone raise your hand if you feel like you know anyone who's been a part of that. All right. All right. We're going to go ahead and look at...

█ Somebody raised their hand, I think.

Adam: Oh, did somebody? Who did? Oh █ who do you know?

█ Well, there's somebody I'm acquainted with and I know that she's on one of the advisory troops.

Adam: And have you learned anything from her? Did she share anything?

█ Nope.

Adam: Nope? Okay. All right. I'm going to go ahead and share again. We can go and read that take a minute and then we'll chat about it.

Adam: All right. Anything super interesting here that you want to talk about or any of the questions about this? Anything that sparks your interest?

█ They hired RBB because of their track record of building lower cost hospitals, they're highly efficient.

Adam: That means something to you?

█ Yeah. They're trying to save money while at the same time trying to build the best quality while saving money at the same time.

Adam: Okay. Anybody else feel like that's a good thing?

█ Well, I think that's where we are. Our community is relatively small. There's a big trading area, but I think it's on par with Merced, and so that makes sense.



Probolsky Research
100 Pine Street Suite 1250
San Francisco CA 94111

San Francisco (415) 870-8150
Newport Beach (949) 855-6400
Washington DC (202) 559-0270

Adam: Okay. All right. Any thoughts on this [REDACTED]

[REDACTED] No, what she said sounds right.

Adam: Okay. We're going to talk about hospital beds, hospital rooms. So I'm going to bring up a visual here and I'm going to talk to you a little bit about it. The current patient rooms in the Mineral King Wing are pie-shaped and not conducive to a positive patient experience. So those, these ones right here on the left-hand side. They are cramped at 118 square feet. They lack space for visitors and moderate healthcare equipment. Patient beds are up against a wall, which limit access to patients and limit the number of staff that can be in the room to assist. The Acequia Wing or -

[REDACTED] Acequia.

Adam: Acequia Wing. Sorry, glad you guys are from Kaweah Delta. So the Acequia wing patient rooms are a bit larger and safer at 149 square feet. It has limited space for visiting family and modern medical equipment. So you see those, whoops, see those in the middle. And then the proposed new rooms, the new wing would be consistent with the current best practices in hospital design, which includes larger rooms at 175 square feet, have a proper bathroom experience, a room for medical equipment, safer overall, and allow family members to stay overnight with their loved ones. So these are the three, the Mineral King on the left, the Acequia in the middle, and then the ideal patient floor plan in the right. Any thoughts on these different scenarios?

Adam: [REDACTED] go ahead and we'll listen to everybody else

[REDACTED] I think the ideal patient room is ideal because I have been a patient in the pie-shaped room and I think that when you have a patient and you have all the equipment that goes into caring for a patient, and you're bringing in IVs and EKG machines and all that other stuff, you need space in order for all of that equipment to be brought into the room. Along with radiology equipment when they come in to do an X-ray and having room to move around makes for a better experience.

Adam: Okay. Anyone else? Thoughts on the different room scenarios here? Yeah. [REDACTED] please.

[REDACTED] I think I would like to add to what she said. Not only is it going to be a better experience for the patients, but for staff, you get injuries all the time. You know, especially if you look at the Mineral King Wing, it's so small. Because I'm a [REDACTED]



Probolsky Research
100 Pine Street Suite 1250
San Francisco CA 94111

San Francisco (415) 870-8150
Newport Beach (949) 855-6400
Washington DC (202) 559-0270

and I see it all the time where people get injured, they're using poor body mechanics. Like you can see on the first picture, the bed is up against the wall. A lot of patients that are immobile, bedridden, they need help repositioning in the bed. And that's where the CNAs and the nurses come in. And they would definitely benefit from something like this, not just the patients.

Adam: Okay. [REDACTED] you had a thought? We'll get to your [inaudible 01:09:52]

[REDACTED] I've been in the pie-shaped rooms dozens of times> Not as a patient fortunately, but visiting others. It's just so awkward and it's really uncomfortable, and you're just kind of like lumped together. I don't know, the ideal plan is the way to go instead of the pie-shaped room.

Adam: Yeah. [REDACTED]

[REDACTED] I appreciate the fact that the ideal patient room allows for family members to stay overnight. So my grandfather, he spent quite a bit of time in the hospital and he's been there for weeks on end without really having the support that he needs with his family because he's there mostly alone for the majority of the time.

Adam: [REDACTED] I see you agreeing. Tell me, what's your thoughts on this?

[REDACTED] I think it's really important. And the reality is that if you... It's going to happen, you're going to have family members packed in rooms, even if you don't plan for it. Because you're going to have parents, spouses and they're going to want to be there. Better accommodate them comfortably.

Adam: [REDACTED] you had a thought?

[REDACTED] I was just going to say, "Yeah." Comfortability is super important, especially when you're in such an uncomfortable situation already, and I like that it allows a family members to stay the night. And it has a lot bigger bathroom and it looks like it has a door there, when you're super cramped in that first left most one. So it just seems like it's a better overall experience for the patient as well as the people who are visiting them.

Adam: All right. So now we're going to talk about two different options that the planning process has come up with. There is, and I'm going to go right to it. The first option, first tower phase, there's this two phase scenario here. You'll see in yellow phase one, a five



Probolsky Research
100 Pine Street Suite 1250
San Francisco CA 94111

San Francisco (415) 870-8150
Newport Beach (949) 855-6400
Washington DC (202) 559-0270

story, 120 bed facility, and then a phase two, four story, 120 bed facility. You've got other services here on the ground floor.

Adam: So the first tower phase will be built and operated for several years before the plan for building the second tower is started. This option gives Kaweah Delta the flexibility as the community needs change. For example, they could build a second tower smaller based on those needs or larger based on those needs. So that's one option that's come up with it, and you can see the details. First tower will cost about 318 million. Here's the cost over time. Other details of the second tower would cost more because it's later on and this is the timeframe that is being contemplating right now, January, 2030 and then the second tower, 2040. Then here is the site plan that the two different towers. So you can see tower one, tower two, tower one, tower two. So I'm going to go through the other tower as well, the other option as well. And then we can come back and talk about both of them.

█ Can you go back to that one slide where you showed the visual of the where... Yes.

Adam: Yeah. This is site one, so first tower, second tower.

█ So the gray is-

Adam: That's existing building now.

█: Right.

Adam: Yeah. All right. So then option two is one tower. So one tower will be built all at one time, but the top floors, the top four floors would be shelves. They wouldn't be built out. It would be kind of like an empty building essentially up there. The hospital would later build them out on a floor by floor basis as needed. And so you can see here, nine stories built. Here's the total cost of 44 to 40 million completed in 2030. We can also get a parking structure by the way. If you look at this one, you get parking structures. And so this option two, and then phase two would be in filling in these floors later on at a cost of about a hundred million or so. And that would be done by approximately January 2040 as needs come available or come up. So this would be the site plan for that. So one tower instead of two.

Adam: So let's talk about the merits of these two possibilities. So you've got option one, two towers, one built sooner, the other will later. Then option two, which is one tower, but the higher floors, the top four floors, just being shells until they build them in over the



Probolsky Research
100 Pine Street Suite 1250
San Francisco CA 94111

San Francisco (415) 870-8150
Newport Beach (949) 855-6400
Washington DC (202) 559-0270

course of time, and there's what it looks like. I don't want to favor one or the other. I'm just going to come back to option one, because I want to rest in one of these and I can move around per your direction. But what are your initial thoughts about the idea of two towers, one at different times and then, or one tower and then extra floors filled in? [REDACTED]. Go ahead.

[REDACTED] Well, that the second option is cheaper. Save quite a bit of money. What is it like over 200 million you'd be saving? So in my opinion, that's the way to go.

Adam: All Right. Anybody else have a thought to towers phased over time or one tower?

[REDACTED] I'm probably going to lean towards the one tower. Main reason as... Well, she said well it is cheaper, but then you're always looking at the future of the hospital and that still gives the ability for more expansion. But using the one tower and making sure you're making the most of it, whether that tower be larger and then adding onto when needed. So I would think better option for what I would see it would be number two.

Adam: All right. [REDACTED] you have a thought?

[REDACTED] Yeah, is it too soon to ask the question of who's going to pay for the parking structure?

Adam: Too soon, but we'll get there. What do you think? It's two towers phased over time or one tower built out over time? What your thoughts?

[REDACTED] I don't know. I didn't see option two.

Adam: Okay, so here's option one is the two towers, phase one and phase two. And then you've got option two, which is just one tower, phase one, phase two.

[REDACTED] I like option one because, I like to know what is going to go in it rather than all these shelves.

Adam: All right. [REDACTED] what's your thought? Which one resonates with you? Which one makes more sense to you? Option one or option two?

[REDACTED] For me, I think option two makes more sense. Even though I do like the ability of having multiple buildings to have set places and people can go. It's a little bit less congested instead of having everything in one building going up and down. But I just think having the ability to expand later on, or just having that one building is pretty important.



Probolsky Research
100 Pine Street Suite 1250
San Francisco CA 94111

San Francisco (415) 870-8150
Newport Beach (949) 855-6400
Washington DC (202) 559-0270

Adam: Okay. Who else has a thought on the design option one or two? [REDACTED] go ahead.
Which one do you prefer?

[REDACTED] Well, option two is more cost-effective, but the other thing is that a has nine floors. So if you're... That elevator is going up and down, you'd have to wait for the top floor to come all the way to the bottom floor. So there's congestions with elevators. And with the other ones, there's just four floors on one and five on the other. So it makes the elevator use a little easier, and if you're running up and down stairs, going up nine flights of stairs versus four flights of stairs is a whole lot easier.

Adam: Anybody else have a thought on which... Go ahead, [REDACTED]

[REDACTED] If Kaweah Delta is looking more with costs, I'm all for option two if they're looking for cost ways to save. The initiative... I mean, option two. Yeah, the one tower, the other option.

Adam: Okay. Anybody else?

[REDACTED] Well, I was just saying just how it would look like having two of the... I don't know. Space-wise of taking over [inaudible 01:19:18] I don't know what I'm trying to say, but it just makes more sense to have one tower to me.

Adam: All right. Anybody else feel like they've got some other thought on that?

[REDACTED] I'd be curious to know how if you build out one tower and you have all these empty floors. I'd be curious to know how that really actually works in the real world and the construction that would be necessary on top of a working hospital. How that would play out. It doesn't seem that it would... Seems like it would be kind of a mess, but I'd just be curious to know if it's been done before. I mean, I assume it's been done somewhere, but...

[REDACTED] It was done.

[REDACTED] Was it really?

[REDACTED] Yeah, it was done when they built the Cross West.

[REDACTED] Did they? I did not realize that.



Probolsky Research
100 Pine Street Suite 1250
San Francisco CA 94111

San Francisco (415) 870-8150
Newport Beach (949) 855-6400
Washington DC (202) 559-0270

Adam: So let's talk about the subject we've all been waiting for, paying for this thing. So paying for all the needed new updated hospital facilities would cost as much as half a billion dollars. You know, \$500 million or more. Kaweah Delta's does not have all the money to pay for this and will need to raise a portion of the funds through a bond measure. As a public hospital, Kaweah Delta treats all patients regardless of their insurance or ability to pay for services. Tulare county is among the poorest counties in California. It has the highest percentage of patients covered by Medi-Cal, which pays hospitals the lowest rates. As a result, Kaweah Delta is paid much less than most hospitals in the state. So that's kind of some context for you. Would you support or oppose a bond measure, kind of generally speaking, would you support or oppose a bond measure to pay for updates needed? So facilities and bottom line, without any of the details, knowing yet. Raise your hand, if you generally support or oppose a bond measure, raise your hand if you support. One, two, three, four, five, six, okay. Seven, eight. All right. [REDACTED], did you not raise your hands?

[REDACTED] Supported the bond measure, so that means as tax payers we would pay, correct?

Adam: Yes.

[REDACTED] Yeah, I already pay lot in taxes and I wouldn't want... I own my own house and the property taxes is a lot. Then I get taxed a lot already from work and then sales tax, it's just ridiculous. I would not want more to pay more taxes than what I already do.

Adam: Okay. [REDACTED] what's your thoughts?

[REDACTED] I'm on the fence.

Adam: You're on the fence. Okay. All right. What do you think, we'll get to most compelling message, but what do you think about the idea of a bond? You know, how do you think it would impact you? [REDACTED] already said that she's already paid so much in taxes and it would be a burden on her. And how would you think they would impact you in a good way and a bad way? [REDACTED] If there is a bad way, or if there is a good way. What are the benefits to you and maybe the negatives to you if there are any?

[REDACTED] I think it would be pretty much neutral. I mean, I could benefit, but it would also hurt in a way. But at the end of the day, I want my family members and myself to be covered. But then again, this is all for the future. So I'll go with the simple answer and say that it would probably hurt me more than help me.



Probolsky Research
100 Pine Street Suite 1250
San Francisco CA 94111

San Francisco (415) 870-8150
Newport Beach (949) 855-6400
Washington DC (202) 559-0270

Adam: Okay. Anybody else have a thought? Is it a net positive for you or more concerned about the cost? What's, part of your decision making?

█ I think a big part of it is going to come down to what's the percentage of what they're going to be taxing us, right? I mean, like I mentioned before, I want to make sure my family has the best medical coverage that they can have. And right now, while we're talking about this, there's, there's no other options than Kaweah Delta. So I want to make sure they have that facilities. I don't want to get taxed, but there's no other options that other care facilities have, unless I want to go to Fresno or I want to go Bakersfield. So it's tough. You're put between a rock and hard place, but I think a big part of it is going to come down to what is the taxes.

█ How much are they getting from the state? How much are they funding themselves and what the impact is going to be on us? I mean, that's a huge... What's going to come down to it. That's huge factor of it.

Adam: Yeah, █ brings up a good point. I think we talked about it a little bit earlier, but the goal, the concept is generally about 50/50, right? About half that raised from taxpayers, about half that raised from revenues and reserves, and grants, and other ways of getting resources to pay for it. █ what do you think? Is this going to be generally a net positive or do you worry more about the cost to you? What's your thoughts on the... How do you weigh your thoughts on supporting or opposing the bond measure?

█ I think generally it's a net positive. I could see though, it affecting people that aren't as well off as I am right now. Those extra taxes, they might only be... Depending on where it's taken it could only be and extra \$50 or \$60, which to me, but to someone that's, coming through paycheck to paycheck, that's a good chunk of money. That could be a meal for the week. So it's a little disingenuous to me to be saying, "Hey, no one's going to be affected." To me, it is a net positive though. But yeah, there's a caveat there.

Adam: All right. So, we're going to talk through some of these numbers and bear with me, because there's a lot of numbers here. But in option one with two towers, I'll go to it and we'll kind of look at it real quick. In option one with two towers, essentially the total cost would be \$684 million to fund updates and facilities. \$319 for phase one, \$365 for phase two. Kaweah Delta would work with banks and other institutions to borrow as much as they could to fund the project. Assuming Kaweah Delta would borrow about half the money or come up with paying about 160 million, taxpayers would be asked to pay the other 159 million in phase one. Then a few years later, phase two would start and you'd have 183 million from the taxpayers, \$182 million from Kaweah Delta, \$183



Probolsky Research
100 Pine Street Suite 1250
San Francisco CA 94111

San Francisco (415) 870-8150
Newport Beach (949) 855-6400
Washington DC (202) 559-0270

million, \$182 from taxpayers, total bond B for the taxpayers to repay, it will be \$342 million. Average property owner would pay an additional \$35 or so per year on every hundred thousand dollars in assessed value rates vary.

Adam: But throughout the years, because it changes over time. But essentially, in the first year would be about \$17 per a hundred thousand. And the highest year, it could be as much as \$67 or \$68 per a hundred thousand for 30 years, the 30 year span to pay back the bond. So for about a \$400,000 house, the homeowner would pay approximately \$142 a year. And the numbers based on \$35 per a hundred thousand at assessed value. That kind of somewhere in the middle based upon the differences over time. So bottom line is that \$142 a year for 30 years. Do you think that's reasonable? Are you still willing to support it? Go ahead, [REDACTED] You're agreeing.

[REDACTED] Yeah, I do agree. I think it's going to serve our community and not to minimize anybody else's like financial situation and the amount of taxes that were pushed on us every single year. I personally don't think that that's much and it'll pay off.

Adam: Okay. So [REDACTED] you earlier expressed some concern. \$142 a year for 30 years to help pay off the taxpayer portion of the bill. Does that help you quantify whether you want to support it or oppose it?

[REDACTED] Yeah, I mean, I would still support it. I mean, my family is still going to live here and our future generations are still going to live here. So it's still going to serve a purpose.

Adam: [REDACTED] how about you? Does that help you understand whether you want to support or oppose it?

[REDACTED] Yeah, I did the math. You said it was a hundred and forty...

Adam: \$142 a year on average, let's say. Yeah, for 30 years

[REDACTED] For 30 years it would be a little over four grand in taxes. It doesn't... Not as much as I thought it was going to be when you put it in numbers.

Adam: Okay. So do you feel like you'd want to support it at this point or how do you feel about it?

[REDACTED] Well, yeah, actually I'm more open to it now seeing the numbers. Now that I can visualize it \$4,260 is not a lot compared to other taxes that we pay.



Probolsky Research
100 Pine Street Suite 1250
San Francisco CA 94111

San Francisco (415) 870-8150
Newport Beach (949) 855-6400
Washington DC (202) 559-0270

Adam: All right. [REDACTED] we put a dollar amount on it. conceptual dollar amount, \$142 a year for the option one. How do you feel about that?

Adam: [REDACTED]

[REDACTED] How do I feel?

Adam: Yeah, \$142 a year.

[REDACTED] The tax money is not the issue for me. The issue is... Well, there are two of them. One is how are we going to sell this to the voters? And that, I think is very important. And number two is something else that hasn't been mentioned. And that is that out on Caldwell and highway-

[REDACTED] Out on Caldwell and Highway 99, there's going to be a big children's hospital built, and I'd be interested in knowing if Kaweah Delta is going to come to us and ask for money for these projects, which I think they're very worthy, how that relates to what other medical institutions are going to be doing in our area.

Adam: Okay. All right. Anyone else, [REDACTED] thought about \$142 a year for Option 1?

[REDACTED] I think it needs to be done. I think that's the obligation that we take on as homeowners in the district. It's got to be done. Nobody wants to be taxed. I don't want to pay another \$150 a year, but I will potentially be using the institution, as well as family members. When you live in an area, you have to support the area.

Adam: [REDACTED] what do you think?

[REDACTED] I was going to say that I don't necessarily think that the \$400,000 housing price is a good lens to look through it in this perspective, just because the average cost of a home in Tulare County is only like \$250,000, so it'll be even less than that. I think even at \$400,000 with \$142 a year, I still think that's a reasonable price, but most people won't even pay that much for it.

Adam: Okay. Good point. All right. So let's look at Option 2 and here is Option 2. Option 2, one tower, costs approximately \$542 million to build, to fund the hospital updates and new facilities, Kaweah Delta would borrow as much as it can. As I explained earlier, assuming again Kaweah Delta would borrow about half the project. Kaweah Delta would pay \$220 million and taxpayers would have a similar \$220 million of a bond. Then a few years later, phase two, and there'd be \$51 million for Kaweah Delta to figure out how to pay



Probolsky Research
100 Pine Street Suite 1250
San Francisco CA 94111

San Francisco (415) 870-8150
Newport Beach (949) 855-6400
Washington DC (202) 559-0270

for, and then taxpayers pay about \$50 million. Total of the two bonds would come to \$270 million. Average property would be \$31 or \$32 a year for every hundred thousand assessed. Again, you'd have high and low points throughout the years for costs, but essentially it would come down to about \$127 or \$128 a year for Option 2. It's a little bit less than Option 1. Anybody have some different thoughts on that? That it's better or worse or moves you towards one of the other options? Any other thoughts?

██████████ Not really.

Adam: Makes sense?

██████████ I'm not sold on either one. I would like to know a little history on this kind of building and how it really plays out and works. I agree with the lady who was talking about the elevator issues. That sounds like a real problem. The more levels you have, potentially more problems.

Adam: Okay. How would you describe what we talked about so far tonight to a friend? You're going to get off this in a few minutes and you're going to be able to talk to someone about what you heard. How would you describe the need for the facility and the costs and how it would be paid for? What would your general, in 22 seconds or less, how would you explain this to someone, ██████████

██████████ First of all, I would say there's a need, right? There's an actual need for the Kaweah Delta to build a new wing, that's up to standards by 2030 for earthquake stuff. There might be some kind of a bond [inaudible 01:34:55] to get half the money needed to proceed with that construction. There are different styles of the building that we can choose and each one will affect us differently, in which way we get taxed.

Adam: All right. ██████████, how would you describe it to someone that you encounter tomorrow?

██████████ Obviously, there's a need for Kaweah Delta to modernize and update that wing. I think it would be our job to help contribute because we are one of the poorest counties in California and Kaweah Delta itself is not going to get the money and these facilities are necessary. So I think a raise in our taxes would be fine to help contribute to it.

Adam: All right. ██████████ how would you describe it to someone, what we talked about tonight?



Probolsky Research
100 Pine Street Suite 1250
San Francisco CA 94111

San Francisco (415) 870-8150
Newport Beach (949) 855-6400
Washington DC (202) 559-0270

Oh, probably on the phone right now or right after. I mean, the point is there needs to be an upgrade. You mentioned that by 2030, the upgrade has to happen because of the earthquake. Why not take that and bring it upon us as community members to support this initiative, because it does impact our community. We are an underprivileged area. It is what it is, and why not modernize it and give the best healthcare out there for our low-income members?

Adam: you're up. You got 22 seconds, . You got to describe what we talked about tonight. How do you describe it to someone? You're on mute, by the way, 22 seconds or less, how do you describe what we talked about tonight?

We talked about a major development in our community that it's not without its problems, but more so, there's some great opportunities. I think what's incumbent now is for Kaweah Delta to do more of the outreach that it's been doing, and to deal with some of the issues that surfaced in the election, in the defeat of the previous bond issue. That worries me very much.

Adam: All right. I'm going to share with you all another slide to read, and I'm going to read through it with you.

Adam: Kaweah Delta has revenues of \$734 million in a year. The health care district, which governs it, receives \$1.2 million in property taxes, right? So just put that in context, the very tiny little amount of property taxes, \$1.2 million, and there's also \$3.1 million from a bond that was passed in 2003 as being paid back. So, less than \$5 million is coming into Kaweah Delta from taxpayers today from taxes and bond repayment.

Adam: Then, for example, \$1.8 million it costs to operate Kaweah Delta on a daily basis. The district's approximately basically lost about \$60 million in COVID-related losses. Just to juxtapose, to be clear, we've got about less than \$5 million coming in, even though some of that's from a bond measure to pay back bonds, but \$1.8 million a day it costs to run the hospital.

Adam: The district has reserves of \$316 million. That's the ability to run about 176 days to operate. Resources, provide world-class patient care, maintain, make modest improvements to facilities. That's what they're able to do today. They don't have the resources obviously to build a new hospital, which would cost hundreds of millions of dollars. I want to focus in on this \$360 million in reserves. They're sitting on cash, guys, right? They got cash in the bank. How do you feel about that? There's cash in the bank



Probolsky Research
100 Pine Street Suite 1250
San Francisco CA 94111

San Francisco (415) 870-8150
Newport Beach (949) 855-6400
Washington DC (202) 559-0270

and then they want to go out and raise money to go build a new hospital. Is that okay to have money in the bank and then go out and raise new money?

██████████ Absolutely. [crosstalk 01:39:33]

Adam: Why is that okay, ██████████

██████████ I think that's okay because they're our major hospital, and we need to make sure they have resources to keep running while we do need to pay for this. If they used all that to help pay or a majority of it, then that kind of limits them if something does come up and they need that money. I'd rather have them have that resources ready for future plans to make sure that a hospital is running at its best capacity and giving the best healthcare that it can give. [crosstalk 01:40:07]

██████████ If we had them use that money, it would be great and it'd help us out in the long run, but with them being our only hospital, I want to make sure they're financially stable and ready for whatever comes their way. I mean, COVID, they're already having some losses. If we used all that, and something happened again, it's not great.

Adam: ██████████ I see you agreeing. You're okay with having them have cash in the bank and still going out and raising money. Tell me why.

██████████ Well, when I read it, I just thought of kind of me personally having my own rainy day fund that I keep aside just in case. I also feel way more confident in the hospital, knowing that they have the funds in case something else pops up, unprecedented.

Adam: The opposing, ██████████, go ahead. Tell me what you think.

██████████ I think that it's beneficial for them to have that kind of money in the bank, because if they need a loan for a piece of equipment that goes down or whatever, then it gives them a better interest rate if they're going to obtain a loan in order to get what they need. Keeping that money in the bank is beneficial for everybody.

Adam: Anybody has an opposing view saying, "Hell no, you got money in the bank, go spend it. I don't want you to come after me for cash." Anybody feel like that? An argument that would sell you?

██████████ I kind of somewhat feel like that. I have like two opinions. I think in our society and with a capitalistic economy, it makes sense. But personally, I also don't think a hospital should be run similarly to a business. I think they do need to have cash in the bank in



Probolsky Research
100 Pine Street Suite 1250
San Francisco CA 94111

San Francisco (415) 870-8150
Newport Beach (949) 855-6400
Washington DC (202) 559-0270

case something happens because we weren't really prepared for COVID or anything like that. Something like that could happen in a moment's notice. So it is important to have some, but maybe not much.

Adam: Okay. All right. Fair enough. We're going to go through some things quickly here so we can get you out on time. Kaweah Delta is going to pay a large portion of the costs of whatever option is chosen. Is that the way you'd characterize it? We've talked about Kaweah Delta paying about half and then the taxpayer's paying about half. Does that make sense to you or is there a different way of saying it? It almost seems like they're kind of the same thing to me. Right? What are you smiling about, [REDACTED]

[REDACTED] They say we're paying a large portion of it. Well, you're paying the same amount that taxpayers are paying. I think that's a bad way to word it.

Adam: How would you say it?

[REDACTED] We'll be paying an equal amount, but I'd say, to pay a large portion is making us feel like, "Oh, you're paying the majority amount," if you're talking like that. But obviously, they're paying half of it and the taxpayer is paying the other half. Using that kind of verbiage is making it a different amount than what it is. Just be upfront. Tell us what it is and what the amount is. Don't beat around the bush.

Adam: How would you characterize it, [REDACTED]? Kaweah Delta's paying half and the taxpayers are paying half. How would you characterize that? How would you say that?

[REDACTED] We're in [inaudible 01:43:22] facilities, too, so why not make it a fair half [inaudible 01:43:29] also. I also hope that... This is probably another topic on funds from the government [inaudible 01:43:34] but I don't know if that would be... Because wouldn't the government money come from their half? Is that what you're saying?

Adam: Whatever they could raise from-

[REDACTED] The proposal.

Adam: Yeah, exactly. [REDACTED] how would you talk about where the money's coming from, and Kaweah Delta putting in half, taxpayers putting in half. How would you characterize that? What words would you use?

[REDACTED] Oh, I don't know. I think, obviously the objective is to promote fairness. Half is coming from here and half is coming from there, and that seems fair, but it is a for-profit



Probolsky Research
100 Pine Street Suite 1250
San Francisco CA 94111

San Francisco (415) 870-8150
Newport Beach (949) 855-6400
Washington DC (202) 559-0270

hospital. I realize we're in the poorest county in the state. I don't see any other way to do it.

Adam: [REDACTED] just said something. She said it's a for-profit hospital. Raise your hand if you think it's a for-profit hospital.

[REDACTED] It is. Is it not?

[REDACTED] No.

Adam: Okay. So one or two... Let's talk about that for a second. If it's a hospital that it's not for profit right there, they're not trying to make a profit-

[REDACTED] Right, but they're running it as a business basically.

Adam: Sure, it's a business.

[REDACTED] That's what I'm talking about. It's not a charity or run by a church or anything like that.

Adam: They need the money to pay the [crosstalk 01:45:20].

[REDACTED] Right.

Adam: So how would you talk about them? Would you call them a nonprofit? Would you call them a not-for-profit? Would you call it a public hospital? What's the words that you would use to describe the hospital as it is? [REDACTED], what would you say? What do you call them?

[REDACTED] Well, like she said. What was it that you said? How did you say it, Katherine?

[REDACTED] It's a for-profit hospital. It's not a charity hospital. That's all I was getting at. I wasn't saying that they were always trying to make a buck. What I meant is that there that they run it as a business and they have to pay the bills and they require community support. It's not a charity, coming from the Catholic church, for instance, or some other source. It's run like a business. When you go to the hospital, you get a bill and you pay for services.

Adam: Anybody have a different way of describing it? Yeah, [REDACTED]



Probolsky Research
100 Pine Street Suite 1250
San Francisco CA 94111

San Francisco (415) 870-8150
Newport Beach (949) 855-6400
Washington DC (202) 559-0270

██████████ Okay, it's a nonprofit district hospital, and the difference is that a for-profit hospital is run by a corporation, and that for-profit, the profit is given to the board. The board on a district hospital receives no funds. There's no benefit to the profit-sharing group. So, a for-profit hospital, if-

Adam: ██████████ how would you describe it? How would you in two or three words, how would you describe Kaweah Delta?

██████████ A nonprofit district hospital. Okay. ██████████, how would you describe it?

██████████ I guess in the most simplest of terms, I might say something like a public hospital.

Adam: Okay. Any other words, ██████████ What words would you use?

██████████: I would agree with Jose and say public.

Adam: Okay. All right. Let's talk real quick about Kaweah Delta has met with surrounding healthcare districts, agencies that are surrounding, that do not have hospitals and talked about something that came up earlier, the possibility of merging, of looking at it. There's no in-depth conversations, but they've talked about the possibility. That would allow the surrounding taxpayers to help support the new facilities and updates.

Adam: What concerns do you have if that happened? Would that change how you feel about the care that you might receive, or the bond, the idea of expanding the boundaries of those district lines? Do you think that would change care in any way, if you had growing the district lines? Raise your hand, if you think care at the hospital would change in any way. Okay. All right. How, if you grew the lines, ██████████ do you think care would change?

██████████ Well, I think when you take those lines out further, we're going out into even more impoverished areas. The only reason that those lines are drawn is for taxes and also for voting in the board members. I think with voting in board members... I apologize for the dogs and background. I think as for that, that would be good because it might diversify the group and it might also be more representative of the group, but as for taxes, since we're going into more impoverished areas, then do we really need to tax those people?

Adam: Okay. So, concerned over that. Okay. All right. Then, much of the advanced healthcare available at Kaweah Delta, open-heart surgery, neurosurgery, cancer care, would not be available to Kaweah Delta if the hospital didn't serve patients from outside the



Probolsky Research
100 Pine Street Suite 1250
San Francisco CA 94111

San Francisco (415) 870-8150
Newport Beach (949) 855-6400
Washington DC (202) 559-0270

healthcare district. When people from outside the district seek care at Kaweah Delta, the bills they pay, help support additional services at the hospital.

Adam: We had talked earlier, Jim had some comments about this concern over people from outside seeking services. Does that change the equation a little bit, this idea that people come in, get high quality care and pay that bill, which actually helps bring the hospital's revenues up? Does that resonate? Or the opposing view of those people are coming in and using our services, and they're probably not paying their bill? Which do you think is more real? Which message do you think you'd latch on to? The fact that the people from outside the district are coming in using the services, not paying their bills or people from outside the district are coming in and having big bills for really high quality care, important care, and paying them and helping lift the hospital's revenues?

Adam: Which one resonates more with you, [REDACTED]

[REDACTED] Neither, and both, I guess.

Adam: If you had to choose, which one? If somebody is making the argument and you've got to buddy up to someone who says one or the other, which one do you choose?

[REDACTED] I always play devil's advocate. I don't go either way.

Adam: [REDACTED], who do you choose? The person who says they're coming in and they're not paying, or the people that says they come in and they're paying the bill for the specialized care they're getting. Who do you believe more?

[REDACTED] I would probably go with the more positive aspect of it.

Adam: Which one is that?

[REDACTED] That they are paying their bills and that's improving the quality of the hospital.

Adam: Okay. Anybody have a thought on this? Which one do you think is more accurate picture? You believe more? Go ahead, and [REDACTED] you have a thought on that. You're muted, [REDACTED], go ahead and unmute yourself, [REDACTED] you're muted. Okay.

[REDACTED] The practical matter is that a large percentage of people's bills are being paid by either insurance, Medicare, Medi-Cal. It doesn't make any difference where they live. That's who's paying the bill. So it's not a total question of hoards of people coming into the



Probolsky Research
100 Pine Street Suite 1250
San Francisco CA 94111

San Francisco (415) 870-8150
Newport Beach (949) 855-6400
Washington DC (202) 559-0270

Kaweah Delta district and using services here and not paying for it. That happens. There's no question about it. But it's not as stark.

Adam: All right, guys, we got a minute or so left. What didn't we get to? What didn't we talk about tonight that we should have gotten to that you wish we did? Yeah. [REDACTED] please.

[REDACTED] Well, I just want to say that within Tulare County, there's three district hospitals. There's Porterville, Tulare, and Kaweah. The people within the county are paying taxes for a hospital. So, the people in Porterville in their boundaries are paying taxes for Porterville's hospital, and the one in Tulare are paying their taxes for Tulare's hospital, because they're all district hospitals.

Adam: Okay. Anybody else? What didn't we get to that we should have talked about? You wish we talked about? You wish you knew more about? Nothing? We solved all the problems already?

[REDACTED] I just want to know when people are coming in and they're voting, there's non-homeowner voters and homeowner voters. When the non-homeowner voters vote, how are you going to persuade them that they should vote for, because they don't own a home and they don't really care. So, that's a large-

Adam: That's a good question. From a district perspective, government agencies can't advocate for anything. There'll be no advocacy, right? There might be a public campaign or someone out there, but the district can certainly educate and explain the dynamics, but that would be for a political campaign, separate from the district.

Adam: I do have one last question. This is something that can be started and it looks like 2030 you can build the first phase and second phase of whatever option's chosen. It could start right away and they could start working on it now, or they can put it off for half a dozen years. Now, costs would go up, but who says, "Let's just get this started right now," and who says, "We should probably put this off for a little bit of time," for whatever reason. Who says start right now? Raise your hand, keep it up. One, two, three, four, five, six, seven. All right. Who says, who said we should wait a little while? One, two, three, four.

Adam: Why should we wait a little while?

[REDACTED] Nobody's got any money and we're trying to get through this pandemic, for one thing.



Probolsky Research
100 Pine Street Suite 1250
San Francisco CA 94111

San Francisco (415) 870-8150
Newport Beach (949) 855-6400
Washington DC (202) 559-0270

Adam: All right. Who else, [REDACTED]

[REDACTED] I was just thinking that we should explore more options for funding instead of them just taking out bonds and stuff. What if there was a campaign to get the government involved or something? Because it is something that is not earthquake reliant, so we should get the government involved and or the governor himself and be like, "Hey, we need funding for this." We can't rely just on the hospital and just on the citizens themselves. Everybody's broke, everybody struggled through 2020. Why don't you give us some money? Why don't you help us out?

Adam: Okay. Any other perspective why we might want to wait?

[REDACTED] How many are on unemployment? So how are you going to start taxing them?

Adam: Okay. I mean, it wouldn't start until 2022 or something like that, but okay. All right.

Adam: [REDACTED]



Probolsky Research
100 Pine Street Suite 1250
San Francisco CA 94111

San Francisco (415) 870-8150
Newport Beach (949) 855-6400
Washington DC (202) 559-0270

Adam Probolsky: Cool. [REDACTED]
[REDACTED] [REDACTED]
[REDACTED] [REDACTED]

Adam Probolsky: Aww. [REDACTED]
[REDACTED] [REDACTED] and I've lived in Visalia for almost 70 years.

Adam Probolsky: Amazing. [REDACTED]
[REDACTED] This is [REDACTED], and I lived in Goshen for the past five years.

Adam Probolsky: Okay. [REDACTED] Your audio is not working, [REDACTED] Make sure you have the microphone selected. Now you're on mute. I'm going to let someone reach out to you and get into that. [REDACTED]
[REDACTED]
[REDACTED]

[REDACTED] Yes.

Adam Probolsky: Okay.
[REDACTED] Yeah [REDACTED] moved to Visalia about 13 years ago.

Adam Probolsky: Okay. And then is it [REDACTED] your audio is not working either.
[REDACTED] Can you hear me now?

Adam Probolsky: Yeah. Perfect.
[REDACTED] Good. Okay. [REDACTED] and I am currently at home all day long with four kids.

Adam Probolsky: Understood.
[REDACTED] Yeah.

Adam Probolsky: [REDACTED]



Probolsky Research
100 Pine Street Suite 1250
San Francisco CA 94111

San Francisco (415) 870-8150
Newport Beach (949) 855-6400
Washington DC (202) 559-0270

Adam Probolsky: Okay. Who else? [REDACTED] what do you know about Kaweah Delta?
[REDACTED] I've read recently that they're going to be changing their name.

Adam Probolsky: Oh, really? Where'd you hear about that?
[REDACTED] At the... Sorry. Visalia Times Delta.

Adam Probolsky: Okay. All right. Okay. All right. This Kaweah Delta, you're talking about the newspaper?
[REDACTED] No, no, no, the hospital.

Adam Probolsky: Oh, [crosstalk 00:06:09].
[REDACTED] You are referring to the hospital, right? Kaweah Delta Hospital?

Adam Probolsky: Yeah. Yeah, yeah.
[REDACTED] Yeah.

Adam Probolsky: All right.
[REDACTED] I think she was saying she read it in the Visalia Times Delta.

Adam Probolsky: [inaudible 00:06:16]. Do you know what you heard... You thought you heard a name change, what name they were going to go with?
[REDACTED] I can't really recall what the name was.

Adam Probolsky: Okay. Anybody [crosstalk 00:06:28].
[REDACTED] I think it was Kaweah Health.
[REDACTED] Kaweah Health.
[REDACTED] Yeah.

Adam Probolsky: Okay. All right. Anybody else have any thoughts on what they know about Kaweah Delta? [REDACTED]



Probolsky Research
100 Pine Street Suite 1250
San Francisco CA 94111

San Francisco (415) 870-8150
Newport Beach (949) 855-6400
Washington DC (202) 559-0270

█
█ I have a fair amount of working knowledge about Kaweah Delta.

Adam Probolsky: Okay. All right. We'll keep going.

█ They have like a ring for delivering babies.

Adam Probolsky: Okay. All right. █ what do you know?

█ Well, I know of them as a competitor. I worked for Tulare Regional for many years. And so they were our top competitor.

Adam Probolsky: Okay. Anybody have anything specific they like about Kaweah Delta?

█ I like some of their doctors.

█ [crosstalk 00:07:26] Medical Clinic...

Adam Probolsky: What was that?

█ I like the concept of Visalia Medical Clinic, which they have obtained, I don't know, how long ago. Where it's kind of an all in one where you can go see your doctor. And if you need a referral to the orthopedic, you walk down the hall, you get an x-ray and then by the time you get to the orthopedics office, he's got the x-ray there in front of him. So I kind of like that perspective of when they acquired Visalia Medical Clinic.

Adam Probolsky: Okay. Anybody else something specific? Yeah, █

█ I like how they try to reach out to the community. The last year before COVID, I was part of a group that got together once a month and they just kind of... I forget what they called them, but it was just a way that they tried to keep you informed and kind of share what was happening.

Adam Probolsky: Okay, █

█ I like how they do the followup. Once you realize one of their services or you make a visit, I like how they send that follow-up to see how your visit went or what your opinion was of, if there was any improvements or anything needed.



Probolsky Research
100 Pine Street Suite 1250
San Francisco CA 94111

San Francisco (415) 870-8150
Newport Beach (949) 855-6400
Washington DC (202) 559-0270

Adam Probolsky: Okay. Anybody have anything they don't like about Kaweah Delta?

█ I'll just say I've only been here for a couple of years and I've only used their services once, it was an ER visit, but I'm pretty sure we were forgotten about in the waiting room or after we were helped for a couple of hours and I had to like track someone down. And so that's been my only experience with Kaweah Delta, so far.

Adam Probolsky: Okay. All right [crosstalk 00:09:10]. Yeah.

█ Are you wanting personal experiences or... What are you looking for?

Adam Probolsky: Whatever you're comfortable sharing for sure. I mean, if you want to share something extra special that you think is great or some dramatically thing, something like Tim that says, you feel like you were not treated well. I'm just interested in your... Yeah, absolutely. If you're comfortable sharing it, I definitely want to hear it.

█ Yeah, for sure. I mean, I've had positives. I have used Kaweah Delta a lot for myself and my kids. So I've had positive experience and I've also had negative experiences like █. I did have an experience at Kaweah Delta that was very negative in the ER department where I was going through a miscarriage and I was bleeding out and it took quite a bit to get medical attention, even though there was blood literally all over the floor. And so I feel like that was a pretty negative experience.

Adam Probolsky: Yeah. I can imagine.

█ In the ER, so.

Adam Probolsky: Wow. █

█ I've had a negative experience in the ER, back in November. It wasn't at the peak of COVID yet, but things were climbing that direction. And I did not at the time... Well, I figured I did, but I hadn't had the positive test yet. And they just put us all in a room with chairs and I literally felt like I was going to pass out and I asked for a place where I can go lay down and they said, "We're sorry, we don't have that. Your vitals look good. You shouldn't be fine in that chair." And the lady next to me was an older lady and she was slumping out of her chair. And by



Probolsky Research
100 Pine Street Suite 1250
San Francisco CA 94111

San Francisco (415) 870-8150
Newport Beach (949) 855-6400
Washington DC (202) 559-0270

the term third time that she slumped out of her chair, they decided to move her into a different area.

Adam Probolsky: Right. Okay. Any inspiration... Oh, yeah, [REDACTED]. Good or bad.

[REDACTED] I had a bad experience in emergency room as well. I took my grandson in, back in December. And two visits into the emergency room and they said he was fine, there was nothing else wrong with him. So third day we took him out to Valley Children's and they ended up keeping him and they admitted him due for respiratory issues. They said, "We can't believe that Kaweah, their emergency department didn't catch that." So it was pretty bad by the time we took them out there.

Adam Probolsky: Okay. Any positive stories, inspirational stories you want to share? Or any Other negative ones.

[REDACTED] I do have some positivity. It seems that like whenever test results are needed, that test results do come back fairly quickly. I know I can normally expect like a pretty quick turnaround to get blood results or lab results. That turnaround has been fairly quick. I know, going in and getting those results is actually a pretty easy process as well. Yeah.

Adam Probolsky: Okay. Yeah. [REDACTED] please.

[REDACTED] I think one thing about Kaweah Delta that a lot of people don't know and don't appreciate is the fact that they have started a residency program for six different disciplines. And we are in a physician shortage area and you have physicians do their training in their residency. There's a high chance that someone will stay in the area upon completing of that. So I think it's a really positive thing that the district has done that really benefits the whole greater community by bringing doctors and hopefully keeping.

Adam Probolsky: Okay. I'm going to share my screen here and let you read a little bit about Kaweah Delta and then we'll chat about it in a second here. So go ahead and take a quick look and read through it and then we'll talk.

Adam Probolsky: (silence)



Probolsky Research
100 Pine Street Suite 1250
San Francisco CA 94111

San Francisco (415) 870-8150
Newport Beach (949) 855-6400
Washington DC (202) 559-0270

Adam Probolsky: Okay. [REDACTED] clearly familiar with these details we assume, but everyone else who else found something surprising, shocking, amazing, scary, exciting [REDACTED] anything interesting to you?

[REDACTED] The general surgery and neurology, that is something that's important for this area. Had family members go through those areas and they were very satisfied with the Kaweah Delta.

Adam Probolsky: Okay. [REDACTED] anything interesting, shocking, surprising?

[REDACTED] I didn't realize it had that many beds. 613, it's a pretty large hospital.

Adam Probolsky: Yep. Okay. [REDACTED] what about you?

[REDACTED] The eight campuses was pretty surprising.

Adam Probolsky: Okay. Anyone else? [REDACTED]

[REDACTED]: [crosstalk 00:14:59] I did not know it was a level three trauma center.

Adam Probolsky: Okay. [REDACTED] you had something?

[REDACTED] Yeah. I just didn't know how comprehensive they were like with neurosurgery cancer treatment. I guess I just assumed... I knew they were the biggest, main hospital. I'm in Visalia, but I just assumed for those services, I'd have to go to Fresno or something.

Adam Probolsky: Okay. [REDACTED] I saw you nodding your head. What's your thoughts?

[REDACTED] Yeah. Same as [REDACTED]. I feel like I've never really noticed how many... I've only really gone to Kaweah Delta when I was really young for ear infections. So just knowing that they have neurosurgery and cancer treatment, I think that's interesting. And especially the mental health services, I feel I haven't really seen that here in the Central Valley as much as other parts of California that I lived in.

Adam Probolsky: Okay. [REDACTED], any thoughts on this?

[REDACTED] When I saw the mention of the cardiac surgery, a friend just mentioned the other day that her sister was having some treatment and that the cardiac department is somehow connected with a larger cardiac department, a



Probolsky Research
100 Pine Street Suite 1250
San Francisco CA 94111

San Francisco (415) 870-8150
Newport Beach (949) 855-6400
Washington DC (202) 559-0270

prestigious cardiac department somewhere else. So I thought that was pretty interesting.

Adam Probolsky: Okay. [REDACTED] anything stand out to you?

[REDACTED] The level three trauma center was what stood out to me. I know it's already been said.

Adam Probolsky: Right. Okay. Anything on here you didn't know, [REDACTED]

[REDACTED] I think one of the things, and just to mention, I think both in neurosurgery and the cardiac, the affiliations with hospitals and, or systems that specialize in those areas really does benefit our communities. The Cleveland center the cardiac center that they interact with. In neurosurgery, is the university of San Francisco's Hospital and their neurosurgeon. So partnerships are really important when you're in an area where you don't have those specialties and it's really does benefit this community.

Adam Probolsky: Okay. All right. Great. So now we're going to look at this map, everyone. And what this map is, we already talked about this being a government agency, right? And a five member elected board. This is the map of the actual boundaries of the agency itself within the grey area. So people who live within the boundaries pay specific taxes to the hospital district, property owners do, anyway. But obviously, anyone who lives outside of this map can show up at the hospital and get treated, wherever you are, you can just go to the hospital, they don't kick you out. Any thoughts on this map or what you think about people from outside the area using the hospital inside the district? [REDACTED] any thought on the map or thoughts on the map or anything interesting about that to you?

[REDACTED] It's interesting to see that... I thought a lot of people from Farmersville and Tulare go to Kaweah Delta because the next big hospital will be in Porterville Or Hanford. And I think the city of Farmersville would commute to Visalia in order to go to the district or to Kaweah Delta.

Adam Probolsky: Okay. Anything else? [REDACTED] anything interesting about this map to you?

[REDACTED] Growing up, I always knew that my friends, Farmersville would come to the hospital here, that's why I find it kind of interesting that it's kind of not involved



Probolsky Research
100 Pine Street Suite 1250
San Francisco CA 94111

San Francisco (415) 870-8150
Newport Beach (949) 855-6400
Washington DC (202) 559-0270

in this diagram. Also just the condensation of the City of Visalia is really interesting to just see.

Adam Probolsky: Great. Okay. [REDACTED] you have a thought?

[REDACTED] When was this map device?

Adam Probolsky: Good question. Just think about the boundaries of cities or the boundaries of counties, right? They probably have some logic to them at the time when they were developed or boundaries of countries, right?

[REDACTED] Because I noticed that the initial statement you've put out in regards to Kaweah, it mentioned that it founded in 1961. So I'm wondering, is this map reflective of the mentality from 1961 or is this updated?

Adam Probolsky: Yeah. I mean, no, it's original boundaries. There may have been some consolidations, but for the most part, it should probably be the original boundaries. [REDACTED] you had a thought?

[REDACTED] Yeah. I was just going to say, I don't have any qualms with anyone using medical resources outside the boundary, but at the same time, I do have the thought of, well, if the default hospital is this for say Tulare and Farmersville, it seems like it makes sense to have them within that boundary as far as contributing tax wise.

Adam Probolsky: [REDACTED] you had a thought?

[REDACTED] The margin at the bottoms of the boundaries were as of September 30th of 2012.

Adam Probolsky: Yeah. So must have been a little bit of a change there. Okay. All right.

[REDACTED] [crosstalk 00:20:38] this map, I can see when Tulare Hospital did close for a year, I think they were down for a year. You can just imagine the influx of people that were shifted to Visalia and then that's why they had to put up the tent and everything else outside to try to handle that overflow.

Adam Probolsky: All right. Yeah. Go ahead, [REDACTED]

[REDACTED] I just want to say, I agree with what [REDACTED] said about... He's put it real well. Obviously we don't want to turn anybody away, but if we know that that's



Probolsky Research
100 Pine Street Suite 1250
San Francisco CA 94111

San Francisco (415) 870-8150
Newport Beach (949) 855-6400
Washington DC (202) 559-0270

where people are going consistently for their healthcare, then it does make sense to have them contribute.

Adam Probolsky: Okay. [REDACTED] please.

[REDACTED] Yeah. What I was going to say is I find that really interesting because I noticed today Tulare has the Kaweah Delta campus, if that's what's officially called a campus or a satellite building, but as well as Exeter. Exeter a pretty big Kaweah Delta Clinic over there as well. So that's interesting in that they don't contribute, however, there's the different campuses that are in those cities. Better satellites, both of Kaweah Delta.

[REDACTED] And the surrounding cities are like Three Rivers, Woodlake. I mean, it would seem like all those would contribute to the Kaweah Delta fund or somehow, because it seems like they're all coming into the city [crosstalk 00:22:14].

Adam Probolsky: [REDACTED] can you turn your camera down a little bit so we can see your whole face or... Yeah, there we go. That's better. Perfect. Okay. Great. All right. So do you trust Kaweah Delta?

[REDACTED] Yes.

Adam Probolsky: Raise your hand if you think you trust Kaweah Delta. Okay.

[REDACTED] You would have to, right?

[REDACTED] I really don't have another choice.

Adam Probolsky: All right. How about... [REDACTED] what's your thoughts?

[REDACTED] I've had some negative experiences, but this was like about 20 years ago when I had to go in there to stay there for a lengthy time for surgery. And there were some rude nurses sometimes. And I just heard other patients ask me for things, they used to say, "You have to wait your time."

Adam Probolsky: So would you put yourself in the category of not trusting Kaweah Delta?

[REDACTED] Yeah. I have some problems with that because these are younger people that were being told they can't get services at that time. And they were in the hospital because they didn't have a need but like I said, this was almost 15, 20



Probolsky Research
100 Pine Street Suite 1250
San Francisco CA 94111

San Francisco (415) 870-8150
Newport Beach (949) 855-6400
Washington DC (202) 559-0270

years ago. So maybe things have changed, new staff, things may have changed and become better at the hospital.

Adam Probolsky: Okay. Yeah. All right. So when you're thinking about who you trust to tell you about the future of the hospital, who is it? Think about the kind of person, a doctor or a nurse, the CEO of the hospital, a board member of the hospital district, business leader in the community, whoever it might be. Who's the person you think you'd want to trust the most to tell you about the future of the hospital? [REDACTED]

[REDACTED] I would probably say a board member. I don't believe that a CEO would really put a lot of information out there because they usually have the spokesperson to do that. But I'd say a board member would probably be the best choice.

Adam Probolsky: All right. [REDACTED]

[REDACTED] I would definitely say the employees because it's the employees who choose to work there. I feel like I would trust the employees more other than a board member.

Adam Probolsky: And what does an employee look like to you? How does that person dress?

[REDACTED] I would have to think about [crosstalk 00:24:41].

Adam Probolsky: Is it someone who works in the billing office or is that someone works more in patient care or...

[REDACTED] I would say more so patient care because it's us, the community who is going into Kaweah Delta and we're dealing with the doctors. We're not... I mean, unless there're issues or whatever, we do meet with billing and et cetera but we are dealing with the doctors, we're dealing with the nurses. Those are who we are interacting with. So if I'm going to put my trust out there, it's going to be to those who I am going to walk in and interact with.

Adam Probolsky: Okay. Let's just go through. [REDACTED] who would you trust to tell you about the future of the hospital?

[REDACTED] I am going with [REDACTED] when she says the people that are working on the line, and the staff, also those that do the followup clinics to help those people when



Probolsky Research
100 Pine Street Suite 1250
San Francisco CA 94111

San Francisco (415) 870-8150
Newport Beach (949) 855-6400
Washington DC (202) 559-0270

they're recovering, those are the people that I would like to hear from them what they think of the future is going to be for the hospital.

Adam Probolsky: Okay. [REDACTED] who would you trust when thinking about the future of the hospital? Who would you want to talk to you about that? What kind of person?

[REDACTED] I like to think it's employees, but it's probably the board of directors.

Adam Probolsky: Okay. [REDACTED], what do you think? Doctor, nurse, frontline staff, CEO, who do you think?

[REDACTED] Well, I feel like the CEO is going to understand the future better because they're making decisions that are five years out, 10 years out. I understand what people are saying about frontline workers. If I could hear from a group of frontline workers, that would be one thing. But you can always have a disgruntled employee who's going to just be real negative and that may not accurately reflect on the situation.

Adam Probolsky: All right. [REDACTED] who would you want to hear from about the future of the hospital?

[REDACTED] I feel like it depends on what the topic is. If it is more about the care of the patients, I think I would want to know about the nurses or people who are directly in contact, not necessarily the doctors, just because I feel like they have a lot of different patients that they'd work with. But if it's things like, I don't know, bigger aspect things, maybe the board of directors, but also maybe bureaucracy might be a thing. So there could be some issues there too.

Adam Probolsky: Okay. [REDACTED] who do you want to hear from? Who do you think you trust the most when it comes to the future of the hospital?

[REDACTED] I'm really encouraged that the people would look to the board of directors. The board of directors are elected by the-

Adam Probolsky: [REDACTED] but I want you to put yourself in the position of civilian resident and just answer the questions in that regard. Who would you trust about the future of the hospital?

[REDACTED] I say the board of directors because they represent all of the stakeholders, both greater community and the employees.



Probolsky Research
100 Pine Street Suite 1250
San Francisco CA 94111

San Francisco (415) 870-8150
Newport Beach (949) 855-6400
Washington DC (202) 559-0270

Adam Probolsky: Great. [REDACTED] who do you think of when you think about the future of the hospital, who would you want to tell you about what's going to happen?

[REDACTED] I think that the board of directors is who I want to hear from. I agree with what [REDACTED] had to say or a group of a hospital members, what might be the biggest voice. But I think we're to see the future, would be the board of directors because they're held accountable by the doctors and the nurses and stuff like that for the future of the... Or what's going on in the future for them.

Adam Probolsky: All right. [REDACTED] who do you think of when you think about the future of the hospital, who would you want to hear from?

[REDACTED] I'd probably lean towards something like the board of directors. Before today, I didn't even realize it was a public governmental thing, but I trust the people that hold the hospital accountable. And my sort of best estimation right now is that something like the board of directors. I'm a little more skeptical of things like CEO and employees because I sometimes wonder if there's ulterior motives or trying to make themselves look good. So probably something like board of directors.

Adam Probolsky: All right [REDACTED] who do you trust? [inaudible 00:28:48] doctor, [crosstalk 00:28:49].

[REDACTED] It wouldn't be the CEO and the CFO as I've been majorly burned in the past when I was in Tulare by the CEO and the CFO. So mine would be more towards the staff and not just any staff, but staff that I know their person... Maybe people I go to church with, many of them work at the hospital. So I have relationships with them and I know them as people, as individuals and anywhere... It doesn't have to just be nurse, but even housekeeping, all the different positions in the hospital, I think gives a good picture. Yes, it might be for the future but if you know where you're at the present, you can kind of see where you might be headed in the future.

Adam Probolsky: Let me throw something out there. And this is not a knock on anyone, but board of directors, they're elected officials. It's kind of the mayor, or a council member or the Congressman, right? They're elected officials granted at a very local area. So we're kind of talking about politicians here, anybody who said that they want to trust the board members want to kind of change their opinion, knowing that



Probolsky Research
100 Pine Street Suite 1250
San Francisco CA 94111

San Francisco (415) 870-8150
Newport Beach (949) 855-6400
Washington DC (202) 559-0270

these are people that run for office, raise money, put themselves on the ballot. They have to sell themselves essentially-

PART 1 OF 4 ENDS [00:30:04]

Adam Probolsky: ... for office, raise money, put themselves on the ballot. They have to sell themselves essentially to voters. Everybody's still on board with the idea of trust in the board of directors? Anybody want to change their position?

█ I wouldn't change my position.

█: I would change position.

Adam Probolsky: You are? Okay.

█ I'm not changing position, but I will say I'm sort of hyper skeptical of anyone delivering a message and so I'm just less skeptical of the board of directors because I view them as being the people the hospital are accountable to.

Adam Probolsky: Okay. It's great. █ why would you change? Based on what I just said, why would you change your position?

█ Because if they're putting in false promises or just to give a-

Adam Probolsky: I didn't see them putting in false promises, I'm just saying that they're politicians at the fundamental level. And just to see if that's-

█ Isn't a politician at the fundamental level would probably be the reason why -

Adam Probolsky: Okay. All right, fair enough.

█ If there was a group of surgeons, like I said, the nurses. These are actual hospital leaders, then I think that would probably be a better message.

Adam Probolsky: Okay. So do you think Kaweah Delta, and I'll have you listened to this and then you can raise your hand for one or the other, you think Kaweah Delta is just a small town hospital you go to because it's close or is Kaweah Delta a hospital you choose for complex care because you think it's the right hospital to go to for that sort of thing? So, small town hospital because it's just close or the hospital you want to go to because they have the ability to treat you for complex things



Probolsky Research
100 Pine Street Suite 1250
San Francisco CA 94111

San Francisco (415) 870-8150
Newport Beach (949) 855-6400
Washington DC (202) 559-0270

and you trust them for that. Who says just a small town hospital to go to because it's close? One, two, three, four, five, six, seven. Okay. Who says it's the hospital you want to go to because it's got what you need? Okay. All right. Interesting.

Adam Probolsky: Can someone name the hospital they'd want to go to? J [REDACTED] where would you go? Shit's going down. Where do you want to be?

[REDACTED] Well, what's the one out by the San Francisco? My minds gone blank on what it's called. Stanford would be if you're really...

Adam Probolsky: All right. [REDACTED] how about you? Where would you want-

[REDACTED] I was thinking Stanford.

Adam Probolsky: Okay. Anybody else have a specific hospital? You're like, I want to be there if something's going wrong.

[REDACTED] I'm from Sacramento and had good experiences with UC Davis Med Center. So I think [crosstalk 00:32:35].

Adam Probolsky: [REDACTED], you had an idea?

[REDACTED] Same thing. UC Davis Med Center.

Adam Probolsky: Okay. All right. So it was referenced earlier, Kaweah Delta is affiliated with the Cleveland clinic for cardiac care. Has a number one range heart program in the nation. Cleveland clinic does. Kaweah Delta is the only hospital in California that has affiliation with Cleveland clinic. Raise your hand if you knew that, if you knew the Cleveland clinic affiliation to today? We've got one, two, three. Okay. Raise your hand if you think that's not necessarily impressive but important if you think that's a really good thing for Kaweah Delta for your community? One, two, three, four, five, six, seven. Okay. All right.

[REDACTED] Can I ask a clarifying... I just don't know what affiliation means so I was sort of torn on [inaudible 00:33:24].

Adam Probolsky: What do you think it means?



Probolsky Research
100 Pine Street Suite 1250
San Francisco CA 94111

San Francisco (415) 870-8150
Newport Beach (949) 855-6400
Washington DC (202) 559-0270

█ That some something at the Cleveland clinic has given some sort of stamp of approval for what's going on at Kaweah Delta. Maybe they send doctors here or something. But I don't know. I have no idea what the affiliation would be.

Adam Probolsky: Okay. Anybody else have a sense of what affiliation means with Cleveland clinic? Quick thought?

█ It means that they are involved with what happens at the Kaweah Delta, that also if they need an expertise or something that they would ask them for help.

Adam Probolsky: Okay. Staci, you have a thought of what that means?

█ It was my understanding that they send doctors here and are in close communication with the doctors for education and making sure that what's going on in Visalia is up to the standards of what they would expect.

Adam Probolsky: Okay. We're going to go real quick on this one, but tell me why it's important to you that Kaweah Delta has the financial and medical resources to provide great quality care? Why is it important to you that Kaweah Delta has the financial and medical resources to provide great quality care? █

█ It is sustainable in the community. It's not going to disappear on us.

Adam Probolsky: Okay. █

█ Financial and the what resources-

Adam Probolsky: Medical. Financial and medical resources.

█ As far as getting the medical resources, I feel like they're almost interwound, but there are conditions that emerged where you might not have that luxury of time to be able to travel to some of these other centers. So, you want to make sure you have it local within your community. That's what would be important to me.

Adam Probolsky: Anybody else why it's important that the Kaweah Delta has the financial and medical resources to have high quality care? Why is it meaningful to you? █



Probolsky Research
100 Pine Street Suite 1250
San Francisco CA 94111

San Francisco (415) 870-8150
Newport Beach (949) 855-6400
Washington DC (202) 559-0270

█ I forgot who mentioned it, but something about how they started having fellowships or something like that for students who want to go into medicine. I think that's just a really great way for Visalia to invest in its own community. So, kids or people who are growing up don't necessarily want to like move out to try to reach their dreams, whereas they can pursue a medical career here where we do have a lack of physicians.

Adam Probolsky: Okay. All right. So, are you aware of any improvements, physical improvements or other that Kaweah Delta need to be made to the facility? Any improvements that Kaweah Delta need to be making to the facility? █

█ Only that needs to be making or are already-

Adam Probolsky: Yeah, needs to be made. Something that you think needs to be fixed or changed or built or something like that.

█ I think that they probably need just more staff in general. There needs to be more, not just physicians, but also nursing staff available.

Adam Probolsky: Okay. How about facilities though? How about like facilities like parking or buildings or machines or medical equipment or anything like that? Anybody know of any facility? Yeah. Go ahead, Sarah?

█ I really think they need to improve the parking.

Adam Probolsky: Parking? Okay.

█ The parking is horrible.

Adam Probolsky: Okay. Anyone else agree, parking is horrible? One, two, three, four, five, six. All right. █ silent on this. I'm sorry. Somebody had another idea of what facilities that need to be improved. Go ahead, █.

█ I was just going to say though, the parking was an issue when I visited but they were also under construction. So, I don't know if that was a temporary thing. I don't know what construction they've been doing, but I got a little lost in figuring out how to get around.

Adam Probolsky: Anybody else know of any facility updates or changes needed to be made, physical things that need to be changed? █ any thoughts?



Probolsky Research
100 Pine Street Suite 1250
San Francisco CA 94111

San Francisco (415) 870-8150
Newport Beach (949) 855-6400
Washington DC (202) 559-0270

██████████ I thought a helicopter pad was supposed to be on top of the roof instead of in the middle of the parking lot.

Adam Probolsky: Okay. ██████████? You know anything that needs to be improved?

██████████ Well, I do but we're faced with losing over 200 beds because of a seismic requirement that is being placed on the hospital and it's looming out there in another 10 years and it's a huge issue to be dealt with.

Adam Probolsky: All right. We'll get to that. Okay. Well, the Mineral King of Kaweah Delta was built over 50 years ago before there were personal computers, mobile phones, before we landed on the moon in 1969 and has not been significantly updated since. This wing, the Mineral King Wing contains 206 of the 435 beds Kaweah Delta has in the downtown campus. There's a need for a more modern facility for it to better serve patients and the Mineral King Wing does not comply with State earthquake standards beyond 2030 and will need to be replaced.

Adam Probolsky: Kaweah Delta is in the planning stages to build new modern hospital wing. In general, do you support or oppose a new hospital wing being built? Raise your hand if you support the idea of a new hospital wing being built? Keep your hand up for me if you're going to say it. Okay. Everybody says yes. Nobody says no? Okay. All right. Why is it important, ██████████ that we build a new hospital wing?

██████████ Well, if it's in the plans, it can be put in through the California government to get funded and not just relied on the taxpayers to pay for it. And 2030 is practically almost here anyways, so it's going to be built whether we agree or I don't know, we would have to vote on it or is it going to be out of code in less than 10 years? So, it sounds like something that's going to be happen anyways.

Adam Probolsky: Anybody else feel they have a sense of why it's important to build a new hospital? Go ahead, ██████████ then ██████████ then ██████████

██████████ I think so. Primary, so we don't lose that bed space as we saw during the pandemic. The room or need for services was just limited on how many services they could provide to the community. So, I think that not losing the beds is a priority.

Adam Probolsky: Okay. ██████████



Probolsky Research
100 Pine Street Suite 1250
San Francisco CA 94111

San Francisco (415) 870-8150
Newport Beach (949) 855-6400
Washington DC (202) 559-0270

█ You hit on the nail. I was going I was going to say, we can't afford to lose essentially a third of the beds we have in the hospital. Walking through that wing, it's very outdated. You could tell it was constructed back in those days.

Adam Probolsky: All right, █ Why is it important?

█ Yeah. Obviously the community is growing, it's not going to shrink, so the need for a hospital or the need for Kaweah Delta is just going to continue to expand. So, losing that many beds would just be detrimental, not helpful in any way, especially with the community growing.

Adam Probolsky: All right. So, when you think about modernizing a hospital, what does that mean to you? Staci, when you think modernizing your hospital, what does that mean to you?

█ Well, obviously bringing within the earthquake requirements but also the computerized part of it. Everything's going electronic health record and so whether it be, I don't know, the nurse pushing the cart from room to room or if there's a computer inside each room that's locked up and only for their access. I don't know what the position is but I think some type of computer. The electronic health record is a huge part of the updated modern services.

Adam Probolsky: All right. █ what does modernization mean to you when it comes to the hospital?

█ Probably similar. I think of integrating technology. Although, I will say I'm a little hesitant when I hear a modernization because sometimes I think it's just an excuse for new. And so if there's false-

Adam Probolsky: Anybody else agree with what █ just said, sometimes modernization is just an excuse for new? Okay. █

█ But yeah. Monetization, I think of keeping up with current standards. So, things like the earthquake and also if it's literally detrimental to caring for patients, say, even just access, if you don't have proper access to all the rooms and equipment in the rooms and things like that. That's what I think of modernization.



Probolsky Research
100 Pine Street Suite 1250
San Francisco CA 94111

San Francisco (415) 870-8150
Newport Beach (949) 855-6400
Washington DC (202) 559-0270

Adam Probolsky: Anybody else might have an idea of what monetization means in the context of the hospital? Go ahead, [REDACTED]

[REDACTED] I think it also means staff. Sometimes you can bring other services into the hospital that you have to refer out to, so it's not just something tangible, it's the people who worked there as well.

Adam Probolsky: Okay. [REDACTED] you had an idea of what modernization means?

[REDACTED] Modernization means to me it's just an electronic part. Having the proper technicians there to upgrade the computers or to submit... I mean, not submit, but to replace certain components to keep that computer upgraded properly. And also this thing with the state codes as far as the earthquake for the community and as far as the hospital too.

Adam Probolsky: Okay. Yeah, [REDACTED] please?

[REDACTED] I think probably updating more to do with like cell phones and waiting in line. Instead of just being there physically, putting like maybe a reservation in or something. And with the whole COVID deal and probably Zoom meetings so that way people can see their loved ones laying in bed or checking on them and stuff like that.

Adam Probolsky: Okay. All right. So in 2016, Measure H, a general obligation bond measure failed to get enough support from voters. So it was on the ballot in 2016 and it failed. Raise your hand if you remember knowing anything about Measure H? Keep your hand up for me. One, two, three, four. Okay. [REDACTED] what do you remember about Measure H?

[REDACTED] Oh, I just remember the voting cycle coming around and the different yard signs out. And then I remember hearing about why it failed and-

Adam Probolsky: Why was that?

[REDACTED] Well, from Kaweah Delta's standpoint, they felt like they didn't communicate well enough. I mentioned earlier that I was in one of these focus groups or... I can't remember what they were called and the lady said one of the big reasons we started these groups is because of Measure H failed and we realized we just weren't communicating the need or the vision well enough with the community.



Probolsky Research
100 Pine Street Suite 1250
San Francisco CA 94111

San Francisco (415) 870-8150
Newport Beach (949) 855-6400
Washington DC (202) 559-0270

Adam Probolsky: Okay. Do you agree with that or does that jive with you? Does that sound logical or not?

█: Yeah, it makes sense. I can't really judge how well they had communicated in the past, but it makes sense that that's part of leadership is communicating.

Adam Probolsky: █ what do you know about Measure H? What do you remember?

█ I don't remember much, but I just remember there was a lot of bad publicity on why they wanted that bond to pass. I just remember there was just a lot of negative comments towards just that bond.

Adam Probolsky: Anything specific?

█ No, not really. I'm sorry. It's been so long.

Adam Probolsky: No, it's fine. Vincent, what about you? What do you remember?

█ I remember that Kaweah Delta was having a rough year that year, I think, and it seemed like they wanted to raise taxes a lot. And it seemed to me it was more of the doctors were going to get the money. Who was going to get all this tax money and where were they going to spend it? And it seems like there was going to raise a lot of taxes at that time in 2016.

Adam Probolsky: Okay. █ why do you think Measure H failed?

█ Lack of communication as was said? We didn't have a good story and we didn't tell it well.

Adam Probolsky: Okay. Okay. Everybody, go ahead and take a quick read of, whoops, of Measure H. And this was the actual ballot question, and then the part of the bottom I added on. We touch on about it in a minute.

Adam Probolsky: (silence)

Adam Probolsky: Okay. Is this jogging anybody's memory? Anybody who didn't already have an opinion on measure H or a thought remember something now? █ yeah.

█ That 48,70 per parcel tax was I remember because it just looking at my tax statement, we're already paying a portion of that to the school district, to the



Probolsky Research
100 Pine Street Suite 1250
San Francisco CA 94111

San Francisco (415) 870-8150
Newport Beach (949) 855-6400
Washington DC (202) 559-0270

colleges. The hospital, I think there's two maybe that we're paying. So, it's just an additional one. That jogged my memory a little.

Adam Probolsky: All right. Anybody else have a thought on Measure H after reading that?

My thing would be, it doesn't seem like Kaweah Delta is broken. So, a \$327 million seems like quite a bit when it doesn't seem like it's broke from the outside, if that makes sense?

Adam Probolsky: Sure, that's helpful. Okay.

Yeah. I'll just say based on reading this, I'm not sure how I would vote. I've only been here for a couple years so I didn't vote on Measure H but it definitely doesn't communicate to me that the idea that we're going to lose 200 beds in the next 10 years if we don't do something. And so that was sort of what motivated me to vote yes when you were pulling us in this. I think Christie was just saying, it sounds like we just want to make things better. I know it mentions the not meeting earthquake safety standards, but that sounds vague. I'm not sure what that would mean.

Adam Probolsky: Okay. [REDACTED], what are your thoughts after reading this?

I would say it's kind of generic and that I think I would have, like Tim said, I would be pulled more towards, this is what we're going to lose if we don't do this, would be a little bit more real, a little bit more tangible than, improve facility treatments for X, Y and Z.

Adam Probolsky: Okay. So, it's interesting. [REDACTED] says, this is what you're going to lose. That would be more compelling to her. We've already talked about the fact that there's 206 beds that are going to not be in compliance with earthquake standards. There's one school of thought that [REDACTED] brings up, this idea of almost the fear of loss versus hope of gain. This idea that someone would tell you, Hey, we're going to shut down a third of the hospital or there's going to be a three-day wait to see doctors. These are just things in my head. I'm just making stuff up. Almost a threat.

Adam Probolsky: My thoughts to you though [REDACTED]s, do you see that as a threat? If someone says, "Hey, we're going to have to shut down a third of the hospital." Does that



Probolsky Research
100 Pine Street Suite 1250
San Francisco CA 94111

San Francisco (415) 870-8150
Newport Beach (949) 855-6400
Washington DC (202) 559-0270

sound like a threat to you? Would you respond to that? Because I want to make sure I'm getting it right. What do you think?

█ I can see where it could depending on how it's put out there. There's people that are much more eloquent in speaking and writing than I would be. I wouldn't want that job, but I think there's a way to do it where you can stress the importance but not scare somebody.

Adam Probolsky: Okay. Anybody agree with that concept? █ yeah.

█ Yeah. I feel like just seeing the number \$327 million without context is just a shock because we didn't really necessarily look at the big budgets. What was it? The police get \$458 million a year or something like that and it isn't necessarily needed, that amount. But this is healthcare, this is people's lives. This makes more sense to me to be able to push towards this rather than other things. But seeing it in context, I think that would help that number.

Adam Probolsky: Okay. █ real quick.

█ Well, rather than threat, and I know that was your word, but I think communicating the need. And so I think being real with people and just like Staci said, if you can say it well, just communicate the reality and the need.

Adam Probolsky: Okay. All right. So Measure H or any future bond measure would only raise some of the money necessary to fund the cost of major hospital modernization and new construction. Kaweah Delta would raise other funds from hospital revenues, loans from banks, grants, whatever other place they could find the revenues. Does that make sense, the idea that a bond measure would cover a big chunk of it and then Kaweah Delta through revenues and loans and other things would be able to accomplish the rest? Anybody think that that's a good plan and a logical plan? Anybody think that's a off the wall or crazy? Okay.

█ I'll also add that if that language is in a kind of measure that's encouraging me to vote because it gives me the sense that, Oh, we're sharing, it's not just putting it all on us, we're sharing the burden.

Adam Probolsky: █ just said sharing the burden. Raise your hand if you like that phrase. We got one, two, three, four, five, six, seven, eight. Okay. █ you don't like that



Probolsky Research
100 Pine Street Suite 1250
San Francisco CA 94111

San Francisco (415) 870-8150
Newport Beach (949) 855-6400
Washington DC (202) 559-0270

phrase? Okay. Well, what does it mean to you when you hear it, [REDACTED] What does sharing the burden mean to you?

[REDACTED] I feel like it wouldn't necessarily be a burden because we're putting it back into the community, but I get the sentiment and I feel like that would be a good way to share it to the masses, but personally...

Adam Probolsky: All right. So after Measuring H failed, Kaweah Delta committed to transparency and education and formed a community engagement initiative. The initiative included ambassador groups, advisory groups, public forums including town halls and webinars. The initial goal was to involve community members in the planning of the future hospital facilities, to listen to feedback and concerns from the community and to involve others in important measures to help build trust. More than 200 community members including one who's here today, [REDACTED] have participated in these community engagement groups, not by design by the way, [REDACTED] you just came up organically. I didn't recruit you for that. I didn't even know who you were.

Adam Probolsky: Do you feel like Kaweah Delta has done a good job expanding their outreach and trust in the community through social media, town halls, virtual forums? Do you think the hospital's done a good job of late doing that kind of outreach to connect with people? Pete?

[REDACTED] I want to say yes. The last couple of years has been a big push for education for the high school and elementary schools and everything and the citizens as well. And I think they're doing a lot better job than what they were doing in the past. So, it's a very positive out there in the community about how the hospital is promoting services that are free to the community, which is good.

Adam Probolsky: All right. [REDACTED] you had a thought?

[REDACTED] I want to say yes, especially with social media. I know when COVID hit, I didn't follow Kaweah Delta's page beforehand. But after COVID hit, I started following their page to get the updates. And I feel like they posted very regularly on their updates and I would see other people would comment on them like, "Hey, could you add X, Y, and Z or also include X, Y, and Z?" And within a reasonable amount of time, they would accommodate the community's request to add different information for like COVID the daily COVID stuff. And so I thought that was really cool. That that was nice.



Probolsky Research
100 Pine Street Suite 1250
San Francisco CA 94111

San Francisco (415) 870-8150
Newport Beach (949) 855-6400
Washington DC (202) 559-0270

Adam Probolsky: Anybody else have a sense of a difference or a renewed sense of trust or feeling you've been outreached to from Kaweah Delta? Yeah, [REDACTED]?

[REDACTED] I feel like I get more emails and I don't know if it was because I did like how [REDACTED] said. Early on in COVID, a friend of mine said, "Check out this one." So I don't know if that got me on a list, but I ended up getting emails where it showed us all the graduates of the different programs or the people being assigned to residencies. So, I thought that was very personable because you can see who was coming in and where they were coming from. So, I feel like I do get more communication from the hospital. I don't know how it started though exactly.

Adam Probolsky: Okay. [REDACTED], do you feel like there has been a renewed sense of outreach and transparency?

[REDACTED] I've seen the commitment. I was part of that ambassadors group. But no question, with COVID, they have really stepped it up and I thought they've done a very good job of trying to be as transparent and providing as much information as they possibly can. I really do think they worked very hard at it.

Adam Probolsky: Anybody else has seen anything outreach wise from the district or from Kaweah Delta? All right. We're going to go to the next slide here. I'm going to share with you, have you read it and we'll talk about it in just a minute. So, I'll let you read through it.

Adam Probolsky: (silence).

Adam Probolsky: Okay. [REDACTED] what stands out to you? What's most interesting to you in there? You're on mute, [REDACTED]

[REDACTED] One thing I like about this it's actually trying to include the community in choosing between this process. I was curious about the RBB part. Were they also the team that was involved in expanding the emergency department?

Adam Probolsky: Okay. Well, we can get your answer on that? Anybody else something stand out here to you? Go ahead, [REDACTED]



Probolsky Research
100 Pine Street Suite 1250
San Francisco CA 94111

San Francisco (415) 870-8150
Newport Beach (949) 855-6400
Washington DC (202) 559-0270

█ I would say what stands out is they have the record of building lower cost hospitals that are highly efficient. That makes me feel better that they are trying to be efficient with money and also look at the building of the hospital.

Adam Probolsky: Okay. Anybody else, anything stand out that... Yeah. █ please?

█ One thing that I had to go back and reread to make sure I read it correctly was quality care for the next 50 years, which I questioned the 300 and something million dollars that the board was asking for and you're only looking at the next 50 years. So, it made me question why only 50? Where did you come up with that number?

Adam Probolsky: I think that's a good question. That's something maybe should be answered, I think. Just thinking in context, the last time the hospital was built 50 years ago and they're looking to replace it because it's gotten to the point where it's reached its lifespan. Anybody else think about that? Anybody I'll say, 50 years? Why aren't we planning for a 100 year hospital or a 200 year hospital? Anybody think that?

█ Yeah, the same thoughts crossed my mind as well. 50 seems like such a low number for such a huge improvement.

Adam Probolsky: Okay.

Adam Probolsky: All right. We're going to go ahead and look at some images here of patient rooms. The current patient's rooms in the Mineral King Wing are pie shaped and not conducive to a positive patient experience. They're cramped at 118 square feet. They lack space for visitors and modern care equipment. Patients' beds are up against a wall which limits access to a patient and limits the number of staff who can help a patient. That's right here. The Acequia Wing patient rooms are a bit larger and safer at 149 square feet and have a limited-

PART 2 OF 4 ENDS [01:00:04]

Adam Probolsky: We got 149 square feet and have limited space for visitors and family and limited space for modern medical equipment. And then the ideal patient room for the proposed new wing would be consistent with current best practices and hospital design includes larger rooms of 175 square feet, have a proper bathroom experience room for medical equipment and safer overall and allow



Probolsky Research
100 Pine Street Suite 1250
San Francisco CA 94111

San Francisco (415) 870-8150
Newport Beach (949) 855-6400
Washington DC (202) 559-0270

family members to stay overnight with loved ones. Any thoughts on these three different setups? Yeah, [REDACTED] go ahead.

[REDACTED] Sorry. It just brought me back to that comment that that gentleman made regarding improvement, expanding or redoing something is basically not really is just new.

Adam Probolsky: Great.

[REDACTED] Looking at your first room compared to your other one, there's a lot of patients that won't utilize everything you're going to be offering in these new rooms. So basically to me it's a waste of money. If you've got patients that are bedridden or don't get a lot of visitors or depending on the need, if I understand maybe like maybe maternity ward or somewhere where a lot of people would want to go visit the new parents and then there's rooms where your urgent care or your other places that don't require, or don't necessarily want all those people in the room. So there's a lot of questions regarding the space and the need for space.

Adam Probolsky: [REDACTED] what do you think about these rooms? These different scenarios, the three different places-

[REDACTED] I've been in the both style of rooms and my wife, she just recently gave birth to the one that's in the middle so that I was accommodating because I was on the sleep on the couch and it felt pretty comfortable to me. And then I visited my grandparents in the room that's on the middle King Wing and it was kind of cramped, but it was like I didn't see anything wrong with it because it had a door, it had a bathroom and it seemed like it was accommodating for like maybe up to two people. So maybe like limited of patients on the first one, but the second one was a really nice room. But I don't know what the improvement the third room would be, it just seems like a much larger room.

Adam Probolsky: Okay, [REDACTED] what's your thoughts?

[REDACTED] I would agree. I think it was [REDACTED] that said like that first room. So I delivered my kids and I believe it was a room more like the middle one, but you only stayed there for like an hour or two and then you got moved to the one on the far left. And as far as like a new parent and like you said, people coming to visit and want to see the baby, I can remember there were people literally standing in that little bathroom area-



Probolsky Research
100 Pine Street Suite 1250
San Francisco CA 94111

San Francisco (415) 870-8150
Newport Beach (949) 855-6400
Washington DC (202) 559-0270

Adam Probolsky: When people say, when I explained that this is a problem because medical equipment won't fit and you can't access the patient on one side and here, similarly, you have issues with appropriate medical equipment fitting and access for family and things like that. Is that compelling to anyone? Raise your hand if you feel like that's compelling one, two, three, four, five, six, seven, okay, seven. So some of you feel that way.

█ It's part of what's compelling though.

Adam Probolsky: What's compelling for you?

█ You saying having enough room for a family and visitors, that's not very compelling to get a larger room. It's the medical equipment that's what's important, to me that compels me. I'm not worried about family coming and staying forever, but I am worried about the appropriate medical care.

Adam Probolsky: And what about not having access to a patient on one side? Raise your hand if that's like, OMG kind of territory, we got to fix that. One, two, three, four, five, six, seven. So pretty much everybody's concerned about access to patients one side except for Sarah. █ you're like, they we'll figure it out.

█ Well, no, I think it all depends like I said on the need, obviously, if you've got a patient that requires more medical care, you're not going to a nicer, bigger room would work. But if you've got a person there that doesn't require that much of care, obviously you're in the hospital, you're going to need the care but I think it all depends on the situation and the condition of the patient.

Adam Probolsky: Okay, all right. Now we're going to look at some of the options because there there's some plans in the works as we've talked about and I'm going to go through two of them. There's option one, which is two towers. And you see it would be conceptually be built in two different phases. So phase one right here, I'm sorry, phase one right here, the more orange. Five stories, 121, 120 beds, five pharmacy and dietary in the lobby, 452 car parking structure. Construction could start in the 26 completed by 30. And here as you see the dollar amount, about 318 and a half million, and you've got, here's your kind of overall total costs and there's some different things in here for construction and increasing cost is as the time goes on. And the EIR, environmental impact report, the reporting you have to do to kind of get to the point where you're able to build.



Probolsky Research
100 Pine Street Suite 1250
San Francisco CA 94111

San Francisco (415) 870-8150
Newport Beach (949) 855-6400
Washington DC (202) 559-0270

Adam Probolsky: And then there later on, you'd build the second tower with four stories, 120 beds, some more parking structure. And here's the details on kind of when the timeline would be and the cost. And then here's the way that would look, right? The first phase, second phase, okay? And then there's an option two where you would have phase one, essentially you'd build all the stories, right? You'd build the nine story structure and here's how it would lay out. But the top four floors would just be shells. So for the first round, from 26 to 30, you'd build this nine story structure and you'd build out the first five stories, and then as need arose, you would increase the actual build-out in the top five floors, and that would be kind of a schedule tentatively 2036 to 2040. And here would be the cost of those two different build-outs.

Adam Probolsky: So, and here's the way it would look here. Just a nine story tower. So concept is a two phases for option one where you build two different towers at two different times. And then option two would be one tower, but just build out of the shells over the course of time. Who has a sense of which option they prefer. Who raises their hand saying two different buildings, option one, raise your hand if you think that's the best plan. One, two, all right. And then raise your hand if you think that building one tower and then kind of keeping them as shells until you build them out is the better option-

█ Adam, I'm sorry I am confused by your slide with all three buildings being on the slide.

Adam Probolsky: Okay. So this one is the two-tower option with first phase, second phase. So option one, phase one-

█ I'm sorry, help me then these two structures over here are the parking garages?

Adam Probolsky: Yes, sir.

█ Thanks.

Adam Probolsky: No problem, so sorry. So option one, two phases of the building, tower one, tower two, and then option a two is one tower where the top floors are shelled and then you'd build them out over time. So we got two people who said they like option number one. And then who says they like option number two? Raise your hand. One, two, three, four, okay. I don't see █ weighing in here.



Probolsky Research
100 Pine Street Suite 1250
San Francisco CA 94111

San Francisco (415) 870-8150
Newport Beach (949) 855-6400
Washington DC (202) 559-0270

██████ Yeah, I'll go with one.

Adam Probolsky: Go with one, all right, so we got three for one. And then who just dropped off for a second there? who did we lose for a minute? Maybe ██████████

██████ Option one.

Adam Probolsky: Okay, all right. So what does everybody think? Tell me why you like your option, option one or option two. Go ahead, ██████████

██████ I don't think nine stories because of the way the structures are around main street and in that area, just a nine story just seems a little bit too big for me or that area.

Adam Probolsky: Okay. Anybody else have a sense of why they like option one, ██████████

██████ Oh, sorry, I voted option two. You want me to hold off a little bit?

Adam Probolsky: No, option two, go for it.

██████ All right. A couple of things, one, I feel like it smaller footprint as far as on the floor, which leaves the possibility for future development. And I also liked, I don't know if we were supposed to be looking at the numbers. It looked like it was cheaper by potentially 100 plus million dollars. So that seemed like two main reasons with smaller footprint and cheaper.

Adam Probolsky: ██████████

██████ Exactly what ██████████ said. I was thinking of this, it's already crowded down there. And so I think that the one structure would have been better. And then I was just trying to quickly add up the two numbers and I thought that that one looked less expensive and I believe it has more parking, I think 500 car parking versus 300 and something parking. So I was of 452. Okay.

Adam Probolsky: You had other parking also in this second phase.

██████ On the second phase of this.

Adam Probolsky: Okay. ██████████ you said option one. Why'd you say option one?



Probolsky Research
100 Pine Street Suite 1250
San Francisco CA 94111

San Francisco (415) 870-8150
Newport Beach (949) 855-6400
Washington DC (202) 559-0270

It just seems like if you pile somebody one big room, elevators and seem they're going to be crowded. If they were two separate buildings, I think would equal more room.

Adam Probolsky: Okay. are you coming back with us?

Yeah, I was going back Just trying to see the pictures a little bit better because I keep searching between the layout.

Adam Probolsky: Go ahead and bring your camera back, that'd be helpful.

Sorry, I didn't realize wasn't up. I just like the layout of option one better.

Adam Probolsky: Okay.

I like the layout look.

Adam Probolsky: Okay, go ahead, You were on option two.

Well, I'd said option one, but I think I've been persuaded to go to option two. The reason I originally said option one was what I think said that it does, or someone said, I can't remember, but it looks a little funny that it's going to be a lot taller than everything else, but the cost is compelling. So if it's going to save a lot of money to do it option two way, I would say do that.

Adam Probolsky: you, I, you said option two. What was your logic there

For me, I liked the flexibility of all of this is based on projections and when exactly you bring on your additional capacity can be very flexible. You can infill those shells over a period of time to meet your demand and do it in a much more cost-effective way than building a second building.

Adam Probolsky: Who agrees with that counsel for just said, the option two gives you flexibility to bring in that build-out and design. Okay. One, two, three, four, five. Okay.

Isn't that the way they did the current tower?

Adam Probolsky: What's that?



Probolsky Research
100 Pine Street Suite 1250
San Francisco CA 94111

San Francisco (415) 870-8150
Newport Beach (949) 855-6400
Washington DC (202) 559-0270

█ Isn't that the way that they did the newest tower that they have there? Jody?

█ Yes. █ filled in the fourth and fifth floor six years after the tower was finished.

Adam Probolsky: All right, █ you had something else to say?

█ Well, I was just looking at the bed space compared to the money that's going to be spent. You're looking at only maybe about 30 beds or a little over 30 beds. There's there's not a lot of more bed space that we're going to get. You're looking at 120 beds on phase one, phase two another 120 beds so it's only 240. Current hospital you said being 206 and the reason we're updating is to make it earthquake compatible, but we're not getting very many beds out of this.

Adam Probolsky: Okay, fair enough. █ what's your thoughts? Which one did you say? You said option two.

█ Yeah, but now I'm thinking about it. I don't really agree, I feel like nine stories might be a little too tall for that area. I like the idea of maybe saving space on the ground, but I think dividing it and maybe like each one having like their own purpose would be a good idea for having two towers.

Adam Probolsky: Okay, all right. So-

█ So I'm not in the business but those beds are going to be like filled up immediately once these things are going to be projected built.

Adam Probolsky: Yeah, I don't know what capacity the hospital operates at, but this is that they're planning for for the future. So do you think there's a problem? Do you think that these are all going to be filled up or do you think they'll plan properly for capacity needs?

█ Hopefully they plan properly for capacity needs, but I just hear the stories about like when COVID broke out, all the hospital beds are filled up and stuff like that. It seems like it has a lot of patients compared to hospital workers.

Adam Probolsky: Anybody else think that? Anybody else think there should be some bigger number of beds?

█ That was the problem with COVID is when it hit and the hospitals weren't designed to carry that many patients at the same time but I feel like that was



Probolsky Research
100 Pine Street Suite 1250
San Francisco CA 94111

San Francisco (415) 870-8150
Newport Beach (949) 855-6400
Washington DC (202) 559-0270

not just unique to Larry County, that that was seen throughout the world [crosstalk 01:15:17].

██████████ If you are planning for the future, you need to increase the bed size, the bed count.

Adam Probolsky: All right. So paying for all the needed new and updated hospital facilities could cost as much as a half a billion dollars, \$500 million or more. Kaweah Delta does not have all the money to pay for this and we need to raise a portion of the funds through a bond measure. As a public hospital, Kaweah Delta treats all patients regardless of their ability to pay and regardless of their insurance. Tulare County is among the poorest counties in California and it has the highest percentage of patients covered by Medi-Cal which pays hospitals the lowest rates. As a result, Kaweah Delta is paid much less than most hospitals in the state.

Adam Probolsky: Would you in general support or oppose a bond measure to pay for the updates needed? Raise your hand if you say based on what you know now you would support a bond measure to pay for the updates and build one of these options. Raise your hand if you say yes. One, two, three, four, five, six, seven, eight. Okay. So ██████████ and ██████████ say no. ██████████ why not.

██████████ Not necessarily aware of what a bond measure is, so was actually kind of looking it up while you were talking.

Adam Probolsky: Okay. You don't have to look it up, we'll talk about it. All right, ██████████ why do you say no?

██████████ It seems like it's just another tax that we're going to have to be paying for something else. Before, we're having here in Goshen, it was the roads and we're all trying to build up tax for the roads. And then now we have a facility being built here in Goshen for the homeless, and then we're going to have to be taxed on that as well. And then now it seems like another hospital bill as is another tax. And it seems like we're already the lowest of the low in Tulare County. And now we're just seems like we're going to be taxed more and more.

Adam Probolsky: Why do you say yes, ██████████ Why are you on board with a bond measure?

██████████ Sorry, did you say me?



Probolsky Research
100 Pine Street Suite 1250
San Francisco CA 94111

San Francisco (415) 870-8150
Newport Beach (949) 855-6400
Washington DC (202) 559-0270

Adam Probolsky: Yeah.

█ I hear it as a necessity and I think there are some public goods that require public support and I think medical care is one of those needs. So I'm not thrilled about... I'm a first time homeowner [inaudible 01:17:48] but I think it's for the greater good and I'm behind it.

Adam Probolsky: Okay. █ why do you think it's something you'd want to support? You're on mute.

█ I was gesturing like I completely agree with what █ was saying right now in terms of like, if that's having the services that a hospital offers, that's a luxury to be able to have that. And that's something that we have here in our backyard to be able to use at our disposal. We want those cardiological services, those neurological services, orthopedic surgery or whatnot. That's something that we have to all pitch in if we all want to reap the benefits of that when the time comes that we may need it.

Adam Probolsky: Okay. █ why do you think you'd be supportive of a bond measure.

█ for the future and for the growth of the community? We're going to get bigger. We're not going to get smaller and we need the services just what █ was saying for the future, we need to have these services available for our community.

Adam Probolsky: Okay. Anybody else has a reason why they generally support a bond measure? █ Why would you?

█ I think it's been well said, it's a community asset that we want and we need.

Adam Probolsky: Okay. █ what about you? What do you, what are you thinking?

█ My opinion was on that was that if it is a high footprint area of the underprivileged, then it is important for it to be updated and remain in that area because if not, then those people may not seek out medical care.

Adam Probolsky: Anyone else? █ your thought?

█ I agree with what everyone has been saying and for what it's worth that especially the way you present it, I kind of feel sorry for Kaweah Delta. It's easy



Probolsky Research
100 Pine Street Suite 1250
San Francisco CA 94111

San Francisco (415) 870-8150
Newport Beach (949) 855-6400
Washington DC (202) 559-0270

to kind of try to blame somebody else, but I'm just thinking, so it's either the state or the federal government that is making them meet earthquake standards, right? They've said this isn't safe but then yet they're not paying them enough through Medi-Cal and it just kind of feels like they're kind of getting screwed to be honest.

Adam Probolsky: Okay. So I'm going to talk through the two options here for a minute and option one with two towers, it would cost \$684 million to fund the hospital updates and new facilities. This would be about 319 million for phase one and 365 million for phase two. Kaweah Delta would work with banks and other institutions to borrow as much as it could to fund the project. Assuming Kaweah Delta could borrow about half the money, Kaweah Delta would pay about 160 million in phase one, a bond measure could cover 159 million about 50 50. Then a few years later, phase two, Kaweah Delta would pay an additional 183 million and the taxpayers would through bond measure pay about 182 million. So again, about 50 50, Kaweah Delta picking up a little bit bigger chunk if all things went according to plan.

Adam Probolsky: The total for the two bonds to taxpayers would be asked to cover would be approximately \$342 million. An average property owner would pay an additional \$35 per year for every \$100,000 assessed. And the actual rates would vary between like \$17 a year and \$67 a year depending on over the course of 30 years, that would fluctuate, but essentially about \$35 a year per \$100,000 . I know these are a lot of numbers. So let's say you have a house that's worth \$400,000, the homeowner would pay approximately \$142 per year for about 30 years. And that's based on, like I said, \$35 and 59 cents a year per \$100,000 .So \$142 a year for 30 years, does that sound logical? Does that sound crazy? Is that a problem? That sounds smart. What's your thoughts on that? [REDACTED] Yeah.

[REDACTED] Well, obviously nobody likes taxes, right. But if you think about what are taxes for and this has been said earlier, but it's like healthcare has got to be in the top three of what taxes are for and between law enforcement. So it's kind of like it's reasonable.

Adam Probolsky: So [REDACTED] says \$142 a year on average for \$400,000 houses property is reasonable. Anybody else think otherwise, think different? Have other words they were associate it. [REDACTED] says reasonable. Is there another word you would associate with that, [REDACTED]



Probolsky Research
100 Pine Street Suite 1250
San Francisco CA 94111

San Francisco (415) 870-8150
Newport Beach (949) 855-6400
Washington DC (202) 559-0270

Well, no one's ever excited to pay taxes, but I would say that I think reasonable is a good way to put it. And if we want to be able to continue to use services... If they lose those beds, then it will eventually affect all of us because we may be the one waiting for a bed, we may be the one who is waiting in the ER for hours and hours and hours for a bed. So I think we have to just realize that, unfortunately, we do have to pay taxes and we would have to assess that and we're getting benefit from it. All of us are getting benefit from it.

Adam Probolsky: do you have a different thought or different ideas of how you'd characterize that kind of money per year for a bond measure?

No, like I said back in 2016, that was the reason why I voted no, but I see that we have to invest in our future so I completely agree with everybody else. Nobody likes taxes, but we have to do it just for everyone's safety and health.

Adam Probolsky: how about you, what do you think about that?

I agree with, with the increase that they're setting up that you're saying about that, when it goes, I have like more clarification so that we have a better understanding of how the money's going to be spent and that it is communicated out to the community. What's the cost going to be in a breakdown? The more communications to the community, the easier it's going to pass.

Adam Probolsky: Well, let's just look at option two real quick. Option two, one tower costs about \$542 million to fund the updates of facilities. Kaweah Delta would borrow again as much as possible. Assuming Kaweah Delta would borrow half, it costs me about 220 million, Kaweah Delta and about 220 million for taxpayers for phase one. Then a few years later, Kaweah Delta would kick in for about 51 million and then 50 million to a bond. A total of two bonds would be approximately \$270 million. On average property owner would pay an additional \$31 per year, that would fluctuate over the course of those 30 years, but an average of \$31 or \$32, let's call it. So for every \$100,000, we're talking about \$62, I'm sorry, we're talking about \$32 a year for a \$400,000 house, we're talking about \$127, \$128 per year. Any different thoughts on that? This is a similar scenario, but you know, basically a few less dollars per year. You'll get, go ahead, .

I was going to say before that I would vote for the previous measure you were suggesting, but it sounds high. Like I don't, I get a kind of sticker shock when I



Probolsky Research
100 Pine Street Suite 1250
San Francisco CA 94111

San Francisco (415) 870-8150
Newport Beach (949) 855-6400
Washington DC (202) 559-0270

go, well, you know, 12, I don't have a \$400,000 house, but \$12 a month? That that's more than Netflix, that's a big bill. And so there's something psychologically that feeling like if it would be less than \$10 a month, sounds a little more palatable. In general I like the cheaper option, just for a number of reasons, but just that reaction to it. I'd vote yes on both of my gut reaction is this one sounds a lot more [inaudible 01:26:53]

Adam Probolsky: So [REDACTED] did some math in his head and came up with \$12 a month. I don't know if anybody else did math in their head, figure somewhere in that range, what comes to mind? What product or service or thing comes to mind when you think that kind of money on a monthly basis? Jorge, something come to mind?

[REDACTED] Going out to get a beer or deciding to get a burger. For 10 bucks to just buy someone, a beer or two and there you go.

Adam Probolsky: All right. [REDACTED] what comes to mind? Some kind of purchase or a service or product when you think about that on a monthly basis.

[REDACTED] Like going out to eat meat or something \$10 is what we spend. Basically, when I go, I think from me, I stop and get a burger, some fries that takes care of it.

Adam Probolsky: J [REDACTED]

[REDACTED] Everything going up I think that compared to what you used to go out now, a beer used to cost a \$1.50 now it's five bucks. So on top of this measures on everything else, there's a measure plus the road measures and every other measure, it seems like is that a reasonable amount but once you start adding three or four reasonable amounts, it starting to pay at the end of the month and end of the year, that the way I think about it.

Adam Probolsky: Anybody else think of some specific product or service they associate that kind of money with on a monthly basis? Nothing comes to mind. [REDACTED], you got something?

[REDACTED] I enjoy Starbucks looking like two and a half Starbucks.

Adam Probolsky: All right. Okay. So we're going to take another look at our... This will be our last slide and I'll have you read through it. Again, a lot of words, a lot of numbers,



Probolsky Research
100 Pine Street Suite 1250
San Francisco CA 94111

San Francisco (415) 870-8150
Newport Beach (949) 855-6400
Washington DC (202) 559-0270

but important to get through. Take a minute or two to read through it. Okay, [REDACTED] what stands out here to you?

[REDACTED] I feel like it's pretty much interesting that they have like [inaudible 01:29:41] 176 like half a year of like operating capital, but it just needs like to build a new hospital is what the issue is when it comes to finances.

Adam Probolsky: Okay. What stands out to anyone else? Yeah, go ahead, [REDACTED]

[REDACTED] So having worked at a hospital before in our management meetings, we always...

PART 3 OF 4 ENDS [01:30:04]

[REDACTED] Did a hospital before we, in our management meetings, we always talked about how many days on cash we had and so that's a really big deal. They would always give us this scenario of nothing else came in at this point, this is how long we could support the rest. So, I think it is important to have that reserve, but I think they need to, if they've got that money and they're going to be transparent, they need to explain that to people because otherwise someone could look and say, Hey, why don't you just spend the money that you have on this project, but you've got to understand what operating days mean and if you don't understand that it was catastrophe for us.

Adam Probolsky: I mean, [REDACTED] brings up a really good point. You're sitting on \$316 million, and you're asking me to come up with cash. Did that go through anybody else's head like hold on here. Oh, you [REDACTED] what were you thinking?

[REDACTED] I think it's measure bond measure M bond and then now we measure H, a bond H has failed. Then I think that again, another 13 years is just going to add another bond and I think about, it seems like every 15 to 20 years they're going to build something different or need something new.

Adam Probolsky: [REDACTED] what was going through your head when you saw that cash on hand?

[REDACTED] I was literally reading the sentence and I saw that reserves of 316 million and the first thought I had was oh, that's a lot. And then the parenthesis about 176 days of operating costs and it whipped me back into reality. The operating



Probolsky Research
100 Pine Street Suite 1250
San Francisco CA 94111

San Francisco (415) 870-8150
Newport Beach (949) 855-6400
Washington DC (202) 559-0270

capital needs to be right next to that dollar amount, it makes sense, but it's easy to see that dollar amount and just go, yeah, they've got the money.

Adam Probolsky: I don't know about you and no one has to raise their hand or tell me, but I would say a large portion of Americans and a big, big portion of Tulare residents don't have 176 days of operating cash on hand. Right? You couldn't pay your mortgage. People can't pay their mortgage or their rent for any extended period of time.

Adam Probolsky: Who thinks of themselves when it comes to your own budget compared to what the hospital has on here and anybody thinking those terms when you're reading this sort of thing? [REDACTED] does, [REDACTED] does, [REDACTED] does, [REDACTED] does, [REDACTED] does, [REDACTED] does. Who also thinks you don't have to agree, just curious, who also thinks, wait a second. Yeah, I wish I had that kind of cash, but I know they need that kind of cash. Like I want them to have that kind of cash on hand. I want to know that my hospital has got money on hand to get [01:32:59] done or if they don't, you want me to be worried about that? [REDACTED] has got a concern about that. One, two, three, four, five, six. give me some other ideas, throw some stuff at me based upon these numbers.

[REDACTED] I'm not responsible for 51,000 people's lives either. It's the employees, the number of employees that they have.

[REDACTED] Also a sign of financial stability is having that cushion and I think it would be concerning of Kaweah Delta didn't have that money if they didn't have that reserve that would be scary.

Adam Probolsky: Having money on hand and just being financially stable allows public agencies to borrow at a better rate. Is that compelling to anyone, this idea that you're financially stable and then when you sell the bonds at Wall street, they'll give you a better rate and everybody, the taxpayers, everybody saves. Raise your hand if that's compelling to you. One, two, three, four, five. [REDACTED] what else? What stands out here? What's going through your mind?

[REDACTED] I think it's important to have the two concepts of operations versus how you pay for a long-term asset and making the distinction that those two things have to be funded in different ways.



Probolsky Research
100 Pine Street Suite 1250
San Francisco CA 94111

San Francisco (415) 870-8150
Newport Beach (949) 855-6400
Washington DC (202) 559-0270

Adam Probolsky: That sounded like balance sheet stuff to me. How do you say that in a way that everybody else gets it?

█ I think 90% of the people buy their home over time. So that's a long-term asset. It's not something that you have to be able to pay for when you walk in the door and building a hospital that has a 50, 60, whatever a year life it is, shouldn't be spread out over the life of the asset and have a payback being able to afford it over that period. So operating money to keep your doors open and to provide the services that you need to do, that's operating. Showing that you're financially secured to do that is very, very important for someone to loan you the money over a longer period of time. I just think you need to separate those two concepts so that people understand that it's two different things.

Adam Probolsky: All right. The fact that Kaweah Delta is going to take on essentially 50% or more than 50% of the load through loans, through revenues, through grants, whatever opportunities that are going to go out and get the resources. Is that an important of this process, knowing that Kaweah delta is going to find half or so of the money and then the taxpayers through a bond are going to come up with the rest. Is that important to you? Raise your hand if that's important to you. Okay, everybody, feels that way.

Adam Probolsky: Now I want you to tell me how you would explain what we're talking about here. How would you explain to your neighbor or your spouse, or a friend, right? We get off this call. You sit there hit refresh, waiting for your incentive and you're talking to somebody and telling them, we're talking about a new hospital thing coming to town. What would you do? Why would you explain it, Pete?

█ Part of it would be going over the hospitals, not meeting some of the codes for quick, and also the expansion that is needed for the future of the community to expand. But also that the hospital has the correct writers to do the grants. If you don't have good writers and put it in the proper wording for the grants, you're not going to get federal money or money from companies that you want to go after. That's crucial. You have to have the creative writers to do the right wording and meet the right people to put in the right wording for that from the hospital. So I don't know if that's in the works right now. That's part of it, get that done.

Adam Probolsky: █ what would you tell someone about the need for new hospital and then how you're going to pay for it?



Probolsky Research
100 Pine Street Suite 1250
San Francisco CA 94111

San Francisco (415) 870-8150
Newport Beach (949) 855-6400
Washington DC (202) 559-0270

█ It hasn't been updated in a while and the thing is we just need equity for things like we need to bringing out to the modern times, so we can want to just provide quality care that's up to date, but also keep at least the same number of beds, if not more so for the future.

Adam Probolsky: What about paying for it?

█ Anything that the public is going to be benefiting from public health pay for it, but the more attractive part that I'll kind of try to emphasize with, my friends or people I talk with about it, but we're not going to be the only ones shouldering it. Half of it's going to be coming from their own efforts. They also got skin in the game, it's not just us.

Adam Probolsky: █ how about you? How do you explain this to a friend or colleague or family member?

█ I agree with █, you first explain the need of why the expansion or why the building needs to take place and then explain the resources that shows a commitment from Kaweah Delta as well to the community to share the cost.

Adam Probolsky: █ how do you explain it?

█ If they don't make these changes, more than 200 beds are going to be lost. Back to what they said, sharing the burden, I think it's nice and easy that you can say they're paying for half and the community's paying for half, that makes it really easy to communicate.

Adam Probolsky: █ what are you going to say to someone if you're talking to them about the subject?

█ I would tell them, it seems like Kaweah Delta is asking for a crap ton of money. However, it seems like it's necessary.

Adam Probolsky: █

█ I think it would be a breakdown of where this money was going and who's handling the money properly because it seems like it's a lot of money and I know that the medical field is top paying and how do we know it's going to these structures and not construction sites and building costs and what about the other hospital in Tulare, are there going to be building that up next? Is this



Probolsky Research
100 Pine Street Suite 1250
San Francisco CA 94111

San Francisco (415) 870-8150
Newport Beach (949) 855-6400
Washington DC (202) 559-0270

the only future in the next 50 years? Are Kaweah Delta going to be the main hospital until Tulare County or is it going to go through also hospital in Porterville? Is that going to be taxed on this as well? I think Kaweah Delta and the money. It seems like a lot.

Adam Probolsky: [REDACTED] what do you tell someone talking about the new hospital wing and,

[REDACTED] Well, Adam, I want to ask a question. Are you going to ask the question that was asked in the previous bond measure in terms of the difference between the tax base and the service area?

Adam Probolsky: We're going to talk to you about that in a minute. Yeah. Right now, what would you tell people?

[REDACTED] That the hospital needs to replace beds and it needs to be done fairly quickly or we are going to be at a loss for services.

Adam Probolsky: Okay. [REDACTED] what do you tell someone about the bond and the need for a hospital? If you think there is a need?

[REDACTED] So I feel like one of the major things for me personally, was the statistic about how we are one of the biggest communities that use like Medi-Cal and that kind of aspect of it. So it's definitely like an underserved kind of community that we have, but this would also be taxed upon like hundreds of thousands of dollars in property. I think that also is something that's important to notice because not everyone's going to have like a \$400,000 house. So it just depends on what kind of situation you're in.

Adam Probolsky: Okay. S [REDACTED] what do you tell someone?

[REDACTED] I think I'm share that 2030 is quickly approaching and explain how the earthquake guides are causing the fact that there's parts of the hospital that will no longer be usable and that Kaweah Delta is willing to shoulder part of the cost of it and that the taxpayers, unfortunately we would have to come alongside them, but in the longterm it would benefit the taxpayers.

Adam Probolsky: [REDACTED] what do you tell someone when you're talking to them about the bond and the need for hospital?



Probolsky Research
100 Pine Street Suite 1250
San Francisco CA 94111

San Francisco (415) 870-8150
Newport Beach (949) 855-6400
Washington DC (202) 559-0270

█ I probably appeal to their self-interest not out of fear, but if things go South and you need a bed and urgent cardiac surgery aren't you going to be glad that we voted yes on this and we can have this in our backyard.

Adam Probolsky: So let's go back to an idea that we talked about earlier that we've got the boundaries for the governmental subdivision just like the boundaries of a city or a County or a water district. That within those boundaries you elect the board members and you pay taxes, if you're a property owner a special tax and help repay the bonds if you're a property owner. But the people that live outside those boundaries don't necessarily don't pay that tax, but still get to use the hospital in the context of, they still get a bill, some of them pay cash, some of them have insurance that pays, some of them have government coverage that pays a lower dollar amount. Is there some concern that those people outside those boundaries get to use the facilities without having to pay that specific tax or repay those bonds. Anybody still has anybody have that concern? █ has that concern, █ One, two, three, four, five, six, seven, eight. █ why not? You're on mute, █ I.

█ I'm not understanding what you're.

Adam Probolsky: Just people within the boundaries of the district to repay the bond but people outside anyone, I'm from Irvine, I can drive up and go to the hospital or someone just on the other side of the line of the district can also go and use the hospital. Does that concern you? Does that bother you at all?

█ No, because you can go to any hospital. I can travel to Santa Barbara and use the hospital there if I wanted to.

Adam Probolsky: █ just brings up a point. I try to illustrate it, but he's the same way. He's one of your neighbors so he said that maybe it's more compelling to you. Anybody can go to any hospital. Why does it bother you that you're paying taxes, if you're a homeowner within the district boundaries and anyone can use it, anyone could use it anyway. What's what's the difference █

█ I think the percentage of people using the hospital that do not live in the district exceeds 50%. So we have the other way to do it is to say, well, let's shrink the hospital to serve the district and not the entire Tulare County.

Adam Probolsky: Okay. So you're saying turn people away.



Probolsky Research
100 Pine Street Suite 1250
San Francisco CA 94111

San Francisco (415) 870-8150
Newport Beach (949) 855-6400
Washington DC (202) 559-0270

█ I'm saying that fine, they can go to any hospital. They can go to Fresno, they can go elsewhere. The district should serve the district.

Adam Probolsky: █ go ahead.

█ I would say the concern there is, realistically speaking, if you're in Farmersville and you are needing to go to the ER, you're not going to drive to Santa Barbara. You're going to drive to your nearest hospital. You're going drive to your nearest ER. Therefore, I believe if you're in the surrounding area, where if there is something going on in your hospital, then they should be paying the taxes on the hospital that is in the nearest area.

Adam Probolsky: So much of the advanced care at Kaweah Delta, open heart surgery, neuro surgery, cancer care would not be available at Kaweah Delta if the hospital didn't serve patients from outside the healthcare district, when people from outside the district seek care at Kaweah Delta, the bills they pay help support the additional services that the hospital can offer. Does this change the way you feel about being able to access care at Kaweah Delta based upon where people live? They're kind of emphasizing the point, I said earlier, everybody pays a bill or gets a bill and some of those really advanced care have really high price tags to them. And those monies from insurance and people paying for them get paid by the people outside the district, which, which allows for some of those advanced cares and really supports those advanced cares care in the district.

Adam Probolsky: What do you think about that, █ Can people that come from outside help pay for some of those things?

█ Outside of that one map with [inaudible 01:47:12] right? My question would be where would you generate more income by just having them pay included into the taxes?

Adam Probolsky: No, no. What I'm saying is the people that come in from outside, they'd get a bill, then they pay that bill and that's a big part of Kaweah Delta being able to offer those services. Does that sound logical?

█ The statement to me itself doesn't make, say like where would you degenerate more income by including them into our taxes or just having them pay as they come, because I'm sure not all of them pay their bills. Many Americans know [crosstalk 01:47:50].



Probolsky Research
100 Pine Street Suite 1250
San Francisco CA 94111

San Francisco (415) 870-8150
Newport Beach (949) 855-6400
Washington DC (202) 559-0270

Adam Probolsky: Whether you pay taxes in the district or not, you still get a bill. When you go to the hospital to get a bill, so it doesn't really matter. [REDACTED] you had a thought?

[REDACTED] It's a question. Are you saying that if they were included in the district that they wouldn't be paying for these services?

Adam Probolsky: No, of course not. I'm just saying that people come from all over the place and get those specialized care and they pay a bill and the fact that you have this larger pool of people that get those services, help support having those services provided and offering at the hospital.

[REDACTED] Either way those services are going to be used, but it's whether or not the surrounding areas that are part of the people who use Kaweah Delta frequently are also contributing to the taxpayers that are helping build this and helping with all of this. Because other than that, it's irrelevant.

Adam Probolsky: Okay, [REDACTED]

[REDACTED] I just want to... oh, sorry.

Adam Probolsky: Go ahead, we'll come to you next [REDACTED] Go ahead, [REDACTED]

[REDACTED] Well, I was just going to ask you, they're not paying, their bills are not higher, right? They're not charged more than people in the district, but yeah, I guess I'm not, there's nothing compelling in what, what you shared about that. I mean, to me, I still say, like [REDACTED] said a while ago, if that is your main hospital, then you should help pay the taxes for it.

Adam Probolsky: Okay, [REDACTED]

[REDACTED] Yeah, I was just going to say that I wouldn't at all before not serving the hospital, not serving people outside the boundary or anything like that. It's relevant that people outside the boundary are using the services and paying their bills. But I, I liked Kristi's point that it seems like the boundaries should be who can reasonably be expected to use this as their default hospital as the tax space. But I wouldn't support closing service to anyone.

[REDACTED] I think I need to clarify when I said it was irrelevant. I meant that the cardio area, people who come in from out of the boundary for the cardio area help supports it. That's irrelevant to the outside communities, also being part of the



Probolsky Research
100 Pine Street Suite 1250
San Francisco CA 94111

San Francisco (415) 870-8150
Newport Beach (949) 855-6400
Washington DC (202) 559-0270

boundaries and helping pay on the taxes. That's the part where it's irrelevant if that makes sense.

Adam Probolsky: Okay. [REDACTED], what, what do you think?

[REDACTED] What are the requirements of the boundary to be expanded and how far of an expansion can the boundaries be placed? Are we saying that we want to expand as far East as Exeter because Exeter and Farmersville do have extensions of the hospital services there in this communities.

Adam Probolsky: Let's talk about that, our last point. Kaweah Delta has met with surrounding healthcare districts that do not have hospitals to discuss emerging healthcare districts or evaluating options that would allow the other districts to help support Kaweah Delta's building of a replacement facility. How do you feel about other healthcare districts consolidating with Kaweah Delta? Any concerns if that comes? Basically expanding that map to include other health care districts and having them help fit the bill for the bond. Anybody oppose that idea? What's that [REDACTED]

[REDACTED] Provide examples like which other healthcare?

Adam Probolsky: Just surrounding communities, adjacent healthcare districts. Who supports the idea of expanding the map and consolidating with other healthcare districts? Keep your hand up if that sounds like a logical thing to you. One, two, three, four, five, six, seven, eight, nine. Everybody thinks that that's a good idea. Okay. But what's the most compelling part of that for you?

[REDACTED] Just the fact that if they're going to be using the services, if they know that they're going to be consistently using the services, that there's going to be an agreement between the two affiliations, then it would make sense that they would help to fit the bill as well.

Adam Probolsky: Okay.

[REDACTED] If people outside the boundaries, are they going to be voting for this measure?

Adam Probolsky: It's possible, right? If you expanded the boundaries and included other residents, other voters in a newer, larger district, it's possible.



Probolsky Research
100 Pine Street Suite 1250
San Francisco CA 94111

San Francisco (415) 870-8150
Newport Beach (949) 855-6400
Washington DC (202) 559-0270

██████████ Because if they're going to be able to take a vote on the boundary on the measure, then I think that they should also share the responsibility.

Adam Probolsky: Okay. ██████████

██████████ It's helpful for people that may not know that there used to be a hospital in dynamo that had its own district. There was a hospital in Lindsay and Exeter that had their own districts. So those districts still exist and there could be a merger, but it's a very complicated process and that's unfortunately what is not allowed this to move forward, but it does make sense since all of those communities are served now by Kaweah Delta. But these historical districts prevent them from being included within the Kaweah Delta district

Adam Probolsky: Political decision. They've got to get together and make a decision. Before we go, thinking about the timeframe when this should happen, we've got this impending 2030 issue of not being able to be out of compliance. A General, you may or may not think there's a specific need. Who says, let's get started now and start moving this forward and have a ballot measure in 2022? Who says this is not the right time, let's put this off for a few years after that? Who says get started right now and, and make it happen? One, two, three, four, five, six, seven, eight, who says, wait, and put this off a few years, this is not the right time? ██████████ does. ██████████ what do you think?

██████████ I would like to see what the rest of the year is going to play out with financially and the raising of gas and everybody's employment situation.

Adam Probolsky: All right, and lastly, what didn't we talk about? What should we have gotten to tonight that we did not get too? Anybody? What'd you wish we talked about? Yeah. ██████████ go ahead.

██████████ The homeless situation in the community. There's people that are sleeping on the freeways, sleeping on the riverbanks, need a better clarification or explanation by the city of LA County. How are they going to help these people in the future?

██████████ They're trying to sneak them in Goshen.

Adam Probolsky: Anybody else? Any thoughts on things that we should have talked about?



Probolsky Research
100 Pine Street Suite 1250
San Francisco CA 94111

San Francisco (415) 870-8150
Newport Beach (949) 855-6400
Washington DC (202) 559-0270



I think that coming out of this COVID period there was one mention of a \$60 million deficit or loss during that came about as a result of COVID. I think a little more explanation needs to be given as to understanding that and how that's going to be dealt with going forward.

Adam Probolsky:

[Redacted text]



Have a good evening.

PART 4 OF 4 ENDS [01:56:05]



Probolsky Research
100 Pine Street Suite 1250
San Francisco CA 94111

San Francisco (415) 870-8150
Newport Beach (949) 855-6400
Washington DC (202) 559-0270

Group 3

Adam: Good evening. Welcome to our discussion group. Thank you for taking the time to join us this evening to talk about health care in Tulane County. There's the big reveal of our topic. My name is Adam Probolsky, I run a research company here in California, and helping me are Shalom and Scarlett tonight. Our goal is to have an open discussion. We are doing this for research purposes only, no one will follow up or try to sell you anything, of course. You will get the incentive. Give me until, probably Monday to get it out to you by email, but you know where to find me, how to reach me, if there're any issues with that. I'm certainly available for questions after the session. We are recording tonight because I can't take notes that quickly, so if everyone can just acknowledge with a thumbs up or a yes, that you're comfortable being recorded. I appreciate that.

Adam: All right. We are on a first name only basis tonight, makes it a little bit easier. So I think I just have to rename [REDACTED] and make it easier for everyone. I think that's everybody. And a couple of ground rules, only one person to speak at once. That will be really helpful, especially in this format. No such thing as a wrong answer, we want positive answers, negative answers, whatever you're really feeling, your true sentiments. And if you agree or disagree, say, "I agree." and say, "Why?" give us a sense of what it is that you're agreeing with or disagreeing with. My role is not to express my opinion, but I may bring up some ideas and see what you think about them. So as a warmup, let's go ahead and say our name the way we want it to be said, the way to be called and one factoid about us. So for instance, I'm Adam, and I haven't been on a plane in 18 months. [REDACTED] go, once you go.

[REDACTED] My name is [REDACTED]

Adam: Wonderful, [REDACTED]

[REDACTED]: [REDACTED], and I'm retired.

Adam: Wonderful, [REDACTED]

[REDACTED] [REDACTED]

Adam: Wow, [REDACTED]

[REDACTED] [REDACTED]



Probolsky Research
100 Pine Street Suite 1250
San Francisco CA 94111

San Francisco (415) 870-8150
Newport Beach (949) 855-6400
Washington DC (202) 559-0270

[REDACTED]



Probolsky Research
100 Pine Street Suite 1250
San Francisco CA 94111

San Francisco (415) 870-8150
Newport Beach (949) 855-6400
Washington DC (202) 559-0270

Adam: All right. [REDACTED]

[REDACTED] Hi, I'm [REDACTED] [inaudible 00:03:56].

Adam: I'm sorry. Say that again?

[REDACTED] I'm a stay at home mom.

Adam: Okay, great. All right, so like you said, unless there's some real background noise, keeping yourselves mic open would probably be helpful because we can have a more free flowing conversation. So first question is what do you know about Kaweah Delta or Kaweah healthcare? Go ahead and chime in and tell me what you know about them. [REDACTED] go ahead. What do you know? [crosstalk 00:04:19].

[REDACTED] The people who work there.

Adam: I'm sorry? Who said that? [REDACTED] you said something? No, okay. Go ahead, [REDACTED]

[REDACTED] Yeah, I know they just rebranded, I was born there, they'd been around Visalia for a very long time in different formats and different names. I know they've been expanding recently. They try to stay downtown to serve Visalia in the surrounding area. They haven't sold out to a larger conglomerate, tried to stay local. I think the reputation has been up and down over the years.

Adam: Okay. Anybody else? What do you know about Kaweah Delta or Kaweah healthca-

[REDACTED] This is [REDACTED] Kaweah Delta, I know that they are like all throughout Visalia and they had several different branches to serve several different needs. So there's not just the main hospital building. You know, they have several different locations, even general practice doctors are a part of their network.

Adam: Okay. Somebody else?

[REDACTED] I know the main Kaweah Delta hospital has been rapidly expanding the last couple of years with the feature of that new emergency room that they're about to finish up.

Adam: Okay. [REDACTED] you're very low when you talk, so if we can get you closer to the... We heard you, but the next time, make sure you're closer to the mic, that be great. [REDACTED] what do you know about Kaweah Delta?



Probolsky Research
100 Pine Street Suite 1250
San Francisco CA 94111

San Francisco (415) 870-8150
Newport Beach (949) 855-6400
Washington DC (202) 559-0270

█ They have a good heart area for heart surgery for people, and I've been there twice, unfortunately, but I like them. They're very friendly. They very helpful.

Adam: All right, █ what do you know about Kaweah Delta.

█ I just had an operation there two weeks ago and, seem to go okay. They've been here a long time. They seem to be involved in the community and I'm glad they're here.

Adam: All right, █, you're new, anything you know about Kaweah Delta, Kaweah health care? █ froze up. Anybody else? █

█ Yeah. I know several people who work there. I do know that I've heard some people go elsewhere for their medical needs. Try to go up to Fresno and some bigger places, but I've heard nothing but good things.

Adam: Okay. All right, █ what do you know about Kaweah Delta?

█ Not very much. I've only lived here for a couple of years and fortunately have not had to go to the hospital at all, but that's about it.

Adam: All right. Raise your hand if you've got something good to say about Kaweah Delta, something you like about them. Yeah, █

█ Yeah, I've had both of my boys born there, so as far as my experience with the baby ward, that was really great. They were very helpful, very nice people.

Adam: Okay. █ you had something to say?

█ Yeah, same with me. My son was born there about two years ago and it was great experience. I've lived here all my life. Kaweah Delta is kind of very synonymous with Visalia, I think if you live in by saw, you probably know someone or several people that live in Visalia or that work at the hospital.

Adam: Okay, █ you had something to add. Just something to know about Delta, something you like about them. Go ahead. You're on mute. By the way.

█ They're a sponsoring institution for medical education and residency programs.

Adam: How do you know that? Where'd you learn that?



Probolsky Research
100 Pine Street Suite 1250
San Francisco CA 94111

San Francisco (415) 870-8150
Newport Beach (949) 855-6400
Washington DC (202) 559-0270

█ I know that because I was hired by Venice health on the family-

Adam: We lost you, █ Your family, what? Okay, let's see if we can help, █. All right. Anybody have... Oh yeah, █

█ I can kind of jump off of what █ said. I know that because I had procedure done at Visalia medical clinic and I had one of the residents along with them, a doctor from Kaweah Delta actually, do the operation, not Visalia Medical Clinic. It was really interesting, my resident was really nice. It was cool because she got hands on experience during the procedure, and then I also had my regular surgeon there the entire time, and I do have friends that work there. I've been in the hospital I think one other time. Got responded really quick. They took care of me really well. I know that other people had different experiences, but every time I've done procedures with them I've been fine.

Adam: Okay. Anybody have something that they don't like about Kaweah Delta or they're there they're not happy with, or they don't like about it. No bad experiences. Anybody want to share █

█ I don't know if it's necessarily a bad experience. My husband was once admitted and we had, not the best experience with communication from some doctors, but I think overall, it was fine, but not the best medical care that we've received of all the locations we've lived and places.

Adam: Okay, we'll come around to everybody. █ You had something not so pleasant to report.

█ Same thing, husband. He went to the hospital to receive some attention from the emergency room, but this was more recently. So it had to do with COVID restrictions also. He was in so much pain that he could hardly even speak for himself, and of course I couldn't be there to help him. And they wanted him to sit in a chair. Sitting in a chair would cause him more pain. He needed to lay in a bed and they wouldn't let him lay in a bed, and then they told him there wasn't enough space for him to be admitted or to have a private space, because he was in so much pain, and they basically sent him home with some drugs and said, there wasn't enough space.

Adam: Okay. █, you had something to share.



Probolsky Research
100 Pine Street Suite 1250
San Francisco CA 94111

San Francisco (415) 870-8150
Newport Beach (949) 855-6400
Washington DC (202) 559-0270

Yeah, I've had a few experiences with Kaweah Delta. Both of my parents who've had strokes in the past. So with my mom it ended up that she wasn't able to get the care that she needed. So she was airlifted to San Francisco with my father. They had a doctor tell us that it was something else that was genetic, and so it kind of put our family into a frenzy for a few days only to find out that it wasn't the case. Just a lot of miscommunication with the doctors and he ended up getting released before he should have and ended up in the hospital again that night with another stroke. [crosstalk 00:11:31]. "Ah man."

Adam: Okay sorry to hear that. [REDACTED]

He is fine now.

This was recent, but my dad just came out of Kaweah Delta. But the first couple of months he was there recovering from the surgery some of the nurses weren't really tending to him properly and weren't giving him the medicine he needed, when he needed it at the time that they're supposed to give it to them. We've complained about it, but since then, it's been a lot better now, but yeah, that was about it.

Adam: Okay. So we're going to move to some information. I'm going to share some information for you to read and then we can talk through them. So go ahead and read through that and then we'll chat. (Silence).

Adam: Okay, [REDACTED] anything stand out? Surprising, shocking, great, bad. What does it mean to you?

The one thing that stood out for me was, that they had a renowned NICU which I didn't realize they had, that's pretty cool. I have two NICU babies. Both my kids were born premature so that's really important to me, and neurosurgery.

Adam: Okay, [REDACTED] Anything stand out to you, anything fascinating that you learned?

The level three trauma center is interesting.

Adam: Okay. [REDACTED] anything interesting to you then?

I think the whole concept of being a hospital district and kind of run sounds more like a government agency that's very unique in healthcare and I'm just starting to understand that whole set up.



Probolsky Research
100 Pine Street Suite 1250
San Francisco CA 94111

San Francisco (415) 870-8150
Newport Beach (949) 855-6400
Washington DC (202) 559-0270

Adam: Okay. Anyone else have something that surprised them, interested them from what they just read?

█ I'm surprised by the number of, "Campuses." whatever that means. I don't know What they all are, I know four or five of them.

█ It's interesting that they have a 5100 employees, pretty impressive.

Adam: Okay. █ anything interesting to you there?

█ Yeah, I had the same one about the level three trauma. I didn't know it was a level three.

Adam: Okay. All right-

█ This is █. I was surprised to notice that we voted for people such as the board of directors. I don't remember voting for anybody [crosstalk 00:14:57].

Adam: Okay. Anybody else have that same reaction?

█ I had a friend who was on the board, so.

Adam: Okay so you knew. █, you've got a thought, something stand out to you.

█ I was just surprised that it has 613 beds and it's the largest hospital in Tulane County, which kind of makes sense why we ran out of beds really quickly during COVID and all that stuff, especially if that's the largest and that's the only amount that they have.

Adam: Okay. All right, so now we're going to look at a map and this is a map of the boundaries of the healthcare district. So while anyone can go to the hospital, right? I mean, if you show up at a hospital, they're going to take you and they're going to treat you. The boundaries of the health care district are right here. You can see the grayed out area and that's within those boundaries. That's who votes for the board of directors and that's also who would pay a tax. So right now let's say there's a bond, there's a small tax that people pay to the hospital district. The people within that boundary pay it. If you're outside of the boundary, you don't. Anything surprising, interesting there at anybody.

█ Yeah, where do people from Farmersville go?

Adam: They go wherever they want to go.



Probolsky Research
100 Pine Street Suite 1250
San Francisco CA 94111

San Francisco (415) 870-8150
Newport Beach (949) 855-6400
Washington DC (202) 559-0270

██████ They don't get any say into what the Kaweah Delta's doing.

Adam: Well sure they don't vote on the healthcare district board of directors. That's true and they don't pay, let's say any special property taxes or any taxes in the district. But, I guess my illustration is I live in Irvine, I can show up at Kaweah Delta and they would help me, and if you were on vacation, Santa Barbara, the hospital's going to treat you there, right? Anybody, anybody concerned about that? The idea that someone from Tulane can show up at the hospital and yet, they're not a part of the hospital district. Anybody concerned about that?

Adam: ██████ tell me why?

██████ I've had experiences with different friends where they've been in different cities and they couldn't receive medical treatment because they weren't a citizen of that specific county and I just think it's weird again, that this is the biggest hospital until every county yet, it seems like Visalia is primarily paying taxes going to this hospital and primarily voting. Even Tulare's not necessarily represented on this specific map. So, that's a little bit concerning. I'm glad that we do serve multiple people, but it's just concerning why only by Visalia and Ivanhoe and Goshen are paying these taxes.

Adam: Okay. All right-

██████ Are these other surrounding cities paying some sort of tax to some other hospital district.

Adam: There are other healthcare districts in the county. So, there's possibility they're paying taxes in other capacities, but right now, keeping in mind that the... I mean we'll talk about a little bit later, but the taxes that you pay, they go directly to the hospital, are very, very minimal. Homeowners pay a very, very small amount for an older bond. Okay, very well. So, let's talk a bit about who you trust, right. Do you trust Kaweah Delta or Kaweah Health? Raise your hand if generically, right, yes or no. Do you trust Kaweah Health? Keep your hand up for me if you do: one, two, three, four, five, six, seven, eight, nine. Okay. So, ██████, you, say no. Why not?

██████ Just because of the experiences with my parents, I've had good experiences with Kaweah Delta. I had back surgery in high school and that went fine. But, you know, with doctors, you're practicing medicine. It's not a for sure thing, so.

Adam: Yeah okay. ██████ why don't you trust them?



Probolsky Research
100 Pine Street Suite 1250
San Francisco CA 94111

San Francisco (415) 870-8150
Newport Beach (949) 855-6400
Washington DC (202) 559-0270

█ I don't know if it's so much, I don't trust them. I think I just trust others more and-

Adam: Who would you trust?

█ ... So for instance, I have a cousin, who's a doctor and worked in the Fresno area. So I honestly look for recommendations from people that I know and, so for mine, it's just personal experience of both. A lot of my friends who work in Kaweah Delta, they like their job and I don't think that they're necessarily saying go somewhere else, but I, from other knowledgeable sources, I find recommendations typically, don't come from there when I'm seeking, whatever medical needs that I have so.

Adam: Alright. So, let's talk about the future of the hospital and who you would trust to tell you about the future of the hospital. Think about the kind of person, right. Is it a doctor? Is it a nurse? Is it the CEO of the hospital? Is it a reporter who's the kind of person that you would trust the most to tell you about the future of the hospital and what might be happening in the future?

Adam: █

█ Yeah, I'm not sure. I guess for reporters, I mean you'd want some who is not bias, obviously. I think coming directly from the hospital would be said in favor of the hospital. The ability to hear both sides on an issue.

Adam: All right. So █ doctor, board member of the hospital, nurse. █ who would you trust the CEO?

█ I would trust CEO and board.

Adam: Why is that?

█ Well, I guess it depends on anything in life. If you trust the media or whoever that with most major companies, you hope that the CEO, especially, is directing and giving the right message what's happening within the company.

Adam: Okay. █ who would you trust to talk to you about the future of the hospital?

█ I mean from a business standpoint obviously the CEO as well, but I don't necessarily trust corporate CEO's to tell me anything so.

Adam: So who, would you trust-



Probolsky Research
100 Pine Street Suite 1250
San Francisco CA 94111

San Francisco (415) 870-8150
Newport Beach (949) 855-6400
Washington DC (202) 559-0270

██████████ [crosstalk 00:21:47] I don't know who I would actually like [inaudible 00:21:49]
[crosstalk 00:21:53] if this is about where the future of the hospital is going to go-

Adam: Okay, but you wouldn't trust them.

██████████ ... Possibly the staff, like lower staff, like nurses. I would trust their perspective on the future of the business, much more than somebody who is profiting more from it.

Adam: Okay. One second, ██████████, who would you trust when you think about the future of the hospital? Who do you want to you to tell you about the future of the hospital?

██████████ Personally? I think it'd be the CEO. I think they're the ones that are going to be very involved in the entire operation. Whether we trust them or not, they're going to be very knowledgeable. They want this to go forward. They want to build a future. They want to connect with the community. I mean, again, whether we trust them or not, that's a whole separate issue, but that's who I would look for because they're the ones that know the business inside and out.

Adam: All right, ██████████

██████████ I would want to separate interviews where they didn't know that they're being interviewed in one interview with the CEO and one interview with the resident and then them telling you what they think the future of the hospital is.

Adam: Okay. All right. Who else has a sense of who.. ██████████, who would you trust to talk to you about the future of the hospital?

██████████ Because of my public health, the stakeholders, meaning community members, family, friends. I would get the insight from the nurses and employees. The CEO, not so much sometimes, but I would more and more like the community. What their perspective would be is a lot for me.

Adam: ██████████ Who would you trust?

██████████ I'd say the board and the CEO, combined effort.

Adam: Okay. ██████████ who would you trust?



Probolsky Research
100 Pine Street Suite 1250
San Francisco CA 94111

San Francisco (415) 870-8150
Newport Beach (949) 855-6400
Washington DC (202) 559-0270

█ I'd say the board or someone who is an actual employee of the hospital districts. Just kind of see what they're actively trying to push and improve and try and make the community better with what they're going to be offering.

Adam: What kind of employee, what does that person look like? What are they wearing?

█ Maybe a nurse or a doctor. Someone who's actually like on the floor. I mean, you can kind of trust a suit, but seeing the experience from someone who is actively working in the environment, I kind of trust the input a little bit more.

Adam: Okay, interesting. █ says actually working in the environment. I mean, raise your hand, if you think people wearing a suit, working, administering the hospital are actually working there or you think that they're not. I mean, it's okay either way. █ says yes, they wearing a suit, they're working there. █ says yes. █ says, yes, everybody else is like, nah.

Adam: All right, okay. This is a kind of a binary choice, right? Do you think Kaweah Delta is just a small town hospital you go to because it's close or do you think it's the hospital you choose for complex care because you want to go there. So raise your hand if you think you go there, just because it's small town hospital, you go to because it's close or... Okay we got one, two, three, four, five, six, seven, eight, nine. Okay and raise your hand if you think you go there because it's the hospital you want to go to for complex care because it's the right place to go: one, two, three.

Adam: Okay. All right. Kaweah Delta is affiliated with the Cleveland Clinic for cardiac care, which has the number one rated heart art program in the nation? Kaweah Delta is not only, the only hospital in California that has a Cleveland Clinic affiliation. Did anybody know that before, I just said it?

Adam: █ says yes, anybody else?

█ I had heard that.

Adam: █ says yes. Does that make a difference to you? The Cleveland Clinic affiliation and raise your hand if that's a good thing, you think it's helpful, one, two, three. Okay, not so impressed, all right.

█ Hey Adam, it's funny that more people didn't raise their hand on that because to me, Cleveland Clinic, the minute you said that it puts me in a whole different... Like I said,



Probolsky Research
100 Pine Street Suite 1250
San Francisco CA 94111

San Francisco (415) 870-8150
Newport Beach (949) 855-6400
Washington DC (202) 559-0270

I've only lived here a short time, but it puts it in a whole different category of top-notch hospitals in the world.

Adam: Yeah. So, tell me why it's important to you that Kaweah Delta has the financial and medical resources to provide great quality care, or why is it important to you personally that Kaweah Delta has the financial and medical resources to provide great quality care.

Because I can never tell when I'm going to wind up in the hospital.

Adam: Okay. All right, anybody else? Why is it important to you? Yeah, [REDACTED]

Well, the same thing, we're 45 minutes away from the nearest large city. So, if you're having an emergency and it doesn't really matter where you are, you go to the place that you're closest to. So to get that care is important.

Adam: Okay, [REDACTED], yeah.

Yeah, just that sense of security, knowing that you don't have to be airlifted somewhere. All this stuff that you need is right there for you, is just a sense of security.

Adam: Okay. Anybody else? Why is it important to you that Delta has the financial and medical resources to provide great quality care?

I got something. [crosstalk 00:27:40] Because you don't know if whatever you have is going to be grave enough or not and you've got to make sure that the hospital has enough funding to provide you the services that you need whenever you do get hurt or any of that sort. You've got to make sure it's well funded, well staffed, and that they're working around the clock to make sure you get the care you need.

Adam: Okay. Anybody else?

I think it's also important, as far as being well-funded and having the right medical supplies, those two kind of go hand in hand because you want them to have the most up-to-date equipment as well. You don't want them to have old stuff that's sitting around necessarily and then also the quality of doctors and nurses. I mean, can they pay better than other places? Are they attracting quality doctors and nurses with pay.

Adam: Who thinks that's important, is the ability to compensate doctors well and keep them around. Raise your hand, keep your hand up. One, two, three, four, five, six, seven, eight, nine, 10, 11. Well, pretty much everybody says that. All right. Well that's great. All



Probolsky Research
100 Pine Street Suite 1250
San Francisco CA 94111

San Francisco (415) 870-8150
Newport Beach (949) 855-6400
Washington DC (202) 559-0270

right, I think [REDACTED] you had another comment of why it's important for them to have financial medical resources.

[REDACTED] Yeah. Well, we're just in the central valley. We have a lot of migrant workers. There's a lot of undocumented workers in general and people need access to a hospital specifically. I remember my infants when I ended up in the hospital. If I had waited a couple more hours, I would have ended up dead, but because it was right there, I would have.

PART 1 OF 4 ENDS [00:29:04]

[REDACTED] More hours, I would have ended up dead, but because it was right there, I would have been fine, but if I didn't know that, and then you caught my case too late, and I tried to go to Fresno. I wouldn't be here today. So that's why it's important to me and just going back to COVID, if we didn't have enough medical supplies, we didn't have enough medical faculty or the central valley would not be treated. We had extreme numbers right in the beginning. And even then we ran out of hospital beds, the first county in California. So that's concerning too.

Adam: Okay. All right. So are you aware of any improvements? Like physical improvements, facility improvements that are needed at Kaweah Delta, Kaweah Health. Anybody, physical improvements, and many things they need to make?

[REDACTED] I've heard that the state is trying to make them replace the main building, because it was not earthquake-safe.

Adam: Okay. Anybody else hear that? All right. Anybody else hear anything else or experience anything else, anything you think needs to be fixed or built or changed physically?

[REDACTED] [crosstalk 00:30:04] construction, but I haven't been inside, but it's like they're doing something.

Adam: Somebody said something about parking.

[REDACTED] Yeah. It's kind of silly. But the main parking area for the Kaweah Delta Hospital is pretty bad with the traffic in that area. It can get pretty congested and try and find a spot anywhere to park is fairly bad. Even though they have the parking garage right across the street from one of the areas, but it's still fairly small.

Adam: Okay. And [REDACTED] you had something?



Probolsky Research
100 Pine Street Suite 1250
San Francisco CA 94111

San Francisco (415) 870-8150
Newport Beach (949) 855-6400
Washington DC (202) 559-0270

█ No, I moved from Carson, California to the central valley of Visalia. There are many one way steets when I went there. I went around three times and if you're not familiar with the streets, parking's a little difficult sometimes.

Adam: Okay. All right. Anybody else? Is there any physical improvements, facility improvements that need to be made at Kaweah Delta? So let me tell you about the Mineral King wing at Kaweah Delta. It was built over 50 years ago before there were personal computers, mobile phones, before we landed on the moon. In fact, in 1969, it has not been significantly updated, really very little done. The wing contains 206 of the 435 beds Kaweah Delta has at the downtown campus. There's a need for more modern facility to better serve patients. The Mineral King wing does not comply with state earthquake standards beyond 2030, and will need to be replaced. Kaweah Delta is in the planning stages to build a new modern hospital wing.

Adam: Do you support or oppose the idea of building a new modern hospital wing at Kaweah Delta downtown? Raise your hand if you generally support the idea, two, three, four, five, six, seven, eight. You didn't have any on that. All right. So █ I think he said we don't have a choice. Why else, █ Why would you support something like that?

█ You waste a lot of money. The danger and the liability aside, just sometimes the infrastructure alone in terms of; heating, cooling and fire, all that kind of stuff. You spend more money just to keep it rather than to have a brand new wing. Infection control was a big deal, there are a lot of new innovations in infection control. There are a lot of new innovations in how structure dictates function in terms of nursing units and team approach and things like that and if you have an outdated set up, it's not going to be conducive to working as a team and that's not going to be good for the patient.

Adam: Okay. Anybody else? Why you support the idea of a new wing. All right. Oh yeah. Go ahead, █ go ahead.

█ It's always good to have updated things, like the gentleman was saying before me, it's a technology thing. You can't keep living in an old house that's outdated and has bad electrical or not good fire safety, that's up to date. It will eventually become a safety hazard.

Adam: Okay. Anybody else? Go ahead, █.

█ Just from like a psychological standpoint, I've lived here my entire life and anytime, any little bit of construction happens in my sailor. We freak out about it. Like, "oh my God,



Probolsky Research
100 Pine Street Suite 1250
San Francisco CA 94111

San Francisco (415) 870-8150
Newport Beach (949) 855-6400
Washington DC (202) 559-0270

like, there's something new" So when we see a brand new wing like that, that's exciting to some people that have been here their entire lives.

Adam: Okay.

█ I agree. I think it makes the hospital more attractive to be updated.

Adam: Okay. Is that important to people having like good aesthetics? Does that make you feel better about the hospital as well as a little bit skeptical? So █ says, yes. Raise your hand if you think aesthetics are kind of important to overall care. One, two, three, four, five, six, seven. All right. Let's talk about modernizing a hospital. What does modernize mean to you, █ What does modernize mean to you in terms of the hospital?

█ Maybe more technology based I've seen with the whole COVID thing happening, how some hospitals, they have almost a mobile robot checking in patients. I think that's pretty much a definition to me of the modernizing. Just a lot of technology, making it easier for the patients.

Adam: Okay. █ what does modernize mean to you when it comes to the hospital?

█ It could be structural modifications that they are in need of per the state, or it could be like they just did with the new ER. Adding facilities, adding areas or changing the use of a certain space to better suit the needs of the hospital.

Adam: Okay. █ what does modernize mean to you when you think of the hospital?

█ I think in general, when you're ill and you go to the hospital, you want to make sure that you're dealing with the best technology possible with what healthcare it is so that you know, that you're in the best hands and that your chances of getting over whatever you have, you come out without any problems.

Adam: All right. █ what does modernize mean to you when it comes to the hospital?

█ I think of the surgical instruments, invasive procedures, and then also accessibility where there's closed captioning. There's more braille there, and even then they also have someone there that's able to assist anyone who's not necessarily familiar with technology and just like location to more outlets, but also within code and fire safety, because there's a lot more technology. So you're going to need more outlets and then also space for those instruments that are brought into the rooms.



Probolsky Research
100 Pine Street Suite 1250
San Francisco CA 94111

San Francisco (415) 870-8150
Newport Beach (949) 855-6400
Washington DC (202) 559-0270

Adam: Okay. [REDACTED] modernize. What does that mean to you? If you're a hospital,

[REDACTED] Like you were saying about technology and equipment. When my son was born, he was born in the newer wing. So to spend some time on NASA hospital, but then you'd have to travel through this maze to make it to the cafeteria, which was outdated and unappealing as well. I mean obviously not hugely important, but you can kind of sense that difference going from new to old. I think it would be nice if everything was as nice as their newer wing.

Adam: All right. [REDACTED] what does modernize mean to you?

[REDACTED] I think of efficiency, both in technology and just practices. I think within a hospital, just making sure that all of the education of the employees and the staff are efficient and thorough to provide that care, not just doing things the same way, because that's the way they've been done, but trying to think of innovative ways to save time and the energy of both the staff and the technology.

Adam: [REDACTED] What does modernize mean to you?

[REDACTED] I think more of the building spaces and the aesthetic, I think of natural lighting, just clean lines. I think now it's like some of the offices where they have the little square patches and the fluorescent lights and gosh, that's just so old and outdated. The absence of those things, and as somebody else mentioned, a better layout, some of the things that are hard to access and confusing to get from one place to another, that's kind of challenging to do in a hospital probably. Those are some of the things that I think of along with, medical technologies.

Adam: [REDACTED] what is modernize mean to you?

[REDACTED] The first thing that pops into my head is technology and equipment, but also focusing on the needs of the community and putting that at the forefront.

Adam: [REDACTED] modernize, what does it mean?

[REDACTED] I think everybody's pretty much covered it and I agree with it. Technology is constantly changing. I just had robotic surgery there, to me that's pretty impressive. The last time I was in a hospital, the new thing was a TV on the wall. So, much more needed and important things that can be done. I'd like to see a new hospital that was up-to-date and aesthetically pleasing is not prime importance, but it is important if you're building a



Probolsky Research
100 Pine Street Suite 1250
San Francisco CA 94111

San Francisco (415) 870-8150
Newport Beach (949) 855-6400
Washington DC (202) 559-0270

new hospital, let's make it look good and work well. It's got to be easy to get through and around and to.

Adam: [REDACTED] how about you? What does modernize mean in the context of a hospital

[REDACTED] Open spaces, integrated areas, functionality, faction control, single patient rooms.

Adam: [REDACTED] what does it mean to you?

[REDACTED] The updated technology, new machines. When I was in the hospital, having a portable x-ray machines, that's always very helpful. If you have a patient that can't make it out of their room, for whatever reason, you have many portable options that can come to them and still give them the care that they need.

Adam: [REDACTED] what does modernize mean to you when it comes to a hospital?

[REDACTED] Like everyone's already mentioned new and up-to-date with the improved equipment and technology, but also the aesthetics, maybe in the waiting room, the colors could be something warm and inviting, and just making me feel comfortable, and the seating sometimes helps to.

Adam: Okay [REDACTED] what is modernize mean to you?

[REDACTED] Kind of how everyone said about the technology, but also to follow up on what Alec said, making sure the buildings up to code, making sure everything is built properly because over the years, the law is going to change the building code changes all that stuff, so you have to make sure everything's running properly and that it's functioning.

Adam: Is there a different word you guys would use? Would anybody use a different word talking about what we were just talking about modernize is the word I used to talk about; updating aesthetics, updating equipment, updating rooms, all those different things is modernized a good word or is there a different word that you would use? Yeah.

[REDACTED] Maybe functional because if you can't use it and it doesn't work for whoever is needing to use it, it doesn't make sense.

Adam: Okay. Anybody else have another word they might use?

[REDACTED] Revitalize? Maybe.



Probolsky Research
100 Pine Street Suite 1250
San Francisco CA 94111

San Francisco (415) 870-8150
Newport Beach (949) 855-6400
Washington DC (202) 559-0270

Adam: Revitalize.

Adam: Right. So we're going to talk about Measure H anybody heard of Measure H before, [REDACTED] says yes. Anybody else? [REDACTED] said yes yesterday?

[REDACTED] Was that the one a few years ago or is this a new one?

Adam: Yeah. It was a few years ago. So you have three people?

[REDACTED] I voted for it.

Adam: [REDACTED] what do you remember about Measure H.

[REDACTED] I think it was a bond to help build new or update the hospital. A lot of people were complaining they didn't want their taxes raised and that sort of thing.

Adam: All right. [REDACTED] what do you remember Measure H

[REDACTED]: It was going to help fund the improvement of hospitals through, increasing taxes or if I remember correctly something about diverting certain taxes towards the hospital.

Adam: So let's take a quick look at information about Measure H. I will let you read through it, and then we will talk, chat about it.

Adam: This was the actual ballot question that was before the voters, and I added this part at the end.

Adam: Anybody have an idea of why they think Measure H failed? Go ahead, [REDACTED].

[REDACTED] I believe it was a property tax for only residents or property owners in Visalia and since the district is much larger than only Visalia and services many areas outside of just Visalia, as well as just property owners in Visalia, most property owners didn't want to pay the whole bill.

Adam: Anybody else have a sense of why it lost

[REDACTED]: 27 million, seems like a lot of money.

J [REDACTED]: I think those people would vote no, against any tax increase, just like a knee jerk reaction.



Probolsky Research
100 Pine Street Suite 1250
San Francisco CA 94111

San Francisco (415) 870-8150
Newport Beach (949) 855-6400
Washington DC (202) 559-0270

Adam: Anybody remember [REDACTED] brought up one. Did anybody remember any other arguments against Measure H.

[REDACTED] I think it was a special election. So the healthcare district opted to spend the money to do a special ballot and everything aside from a regular voting period.

Adam: So Measure H or any bond, future bond, quite frankly, would only raise some of the money necessary to fund the cost of a major hospital re-modernization and new construction. Kaweah Delta would raise other funds from hospital revenues, loans and grants.

Adam: Does this make sense? Is it a good plan? The idea of if the hospital were to go out with a similar situation, you got to raise money to build and modernize a new hospital. Is that a good plan to raise some of the money from the voters, from the property owners and some of the money from revenues and other sources, grants, and things like that, is that logical, or is that sound not logical? [REDACTED]

[REDACTED] I've done like philanthropy work, and I've also like served on eight councils where we give out grants, review grants and stuff and half of the time we have to have commitment and they have to raise a portion of the grants for accountability. So I could see how they're wanting to raise the funds and raising it from grants and other outside stuff. They are wanting to get plans from community because they serve the community, but I think it just goes back to the fact that if you pull up that map again and you see the amount of people that are paying that taxes, it is very, very small compared to the district or the entire county. And that's just to, it's saying it's serving, but anyone could come to Kaweah Delta and still get served and the amount that they're issuing in these bonds. It's almost impossible to rate that in grants and just the revenue that they're gaining from the hospital. So to ask that, obviously you're asking community for more than you're probably going to contribute. So, that is definitely a little deterring.

Adam: Okay. Anybody else? The concept of raising some of the money from property taxes, raising some of the money from revenues and borrowing and other places, does that make sense or does that not make sense?

[REDACTED] Makes sense to me.

[REDACTED] I would say that anyone that's paying taxes should contribute not just property owners.



Probolsky Research
100 Pine Street Suite 1250
San Francisco CA 94111

San Francisco (415) 870-8150
Newport Beach (949) 855-6400
Washington DC (202) 559-0270

Adam: So after the failure of Measure H, Kaweah Delta committed to transparency and education informed the community engagement initiative. This initiative included ambassador groups, advisory groups, public forums, including town halls and webinars. The initial goal was to involve community members in the planning of future facilities to listen to feedback and concern from the community and to involve others in important measures to help build trust, more than 200 community members have participated in these groups.

Adam: Does anybody know anybody who's participated in any one of these groups, any of the outreach by Kaweah Delta? Do you feel like Kaweah Delta has done a good job expanding their outreach and being more transparent in the last couple of years? Anyone raise your hand, if you feel like they've done a good job of being more transparent and doing better outreach, anyone feel like they're doing a worse job, nobody has a sense of it. So let's go ahead and talk a little bit about the future of the hospital to go ahead and read this and then we'll chat about it.

Adam: Okay. We'll take one more minute and then we'll talk. Anybody have anything that surprised them, interest them, what comes to mind when you see this. [REDACTED]

[REDACTED] That's a big process they're going through to get the bidding and building ideas for the hospital. It seems to be good to me that they're getting an architect that has done a similar size hospital as ours, because that way they would perhaps know the size limitations of what everything they would need to go into there to help the same size of a community and a hospital. I think it needs to be done. So got to start somewhere, right?

Adam: Yeah. [REDACTED] anything stand out to you, anything super interesting to you.

[REDACTED] I mean, if they started with that many and they got down to two, I don't know that they should decide one way or the other based on the community. I can't imagine they are very different, but maybe you will show me something that will look very different, but I'm assuming they look pretty similar.

Adam: [REDACTED] you had something to say.

[REDACTED] Is this talking about the last bond?

Adam: No, this is going to going forward. We haven't talked about a bond yet. This is just the idea of building something.



Probolsky Research
100 Pine Street Suite 1250
San Francisco CA 94111

San Francisco (415) 870-8150
Newport Beach (949) 855-6400
Washington DC (202) 559-0270

██████████ I know that is what's coming, because I remember this process was done last time and it did not work out. So they've got to figure out something that will get more people involved, and in fact, I'm fairly involved with the city and I have not seen any of this stuff, I have not seen the plans. I have not seen anything about committees or citizen input or anything at all. So it seems like they are not getting the word out.

Adam: They got to show some more respect to ██████████

██████████ I would agree with ██████████ on that. I live in Visalia. I work downtown and this is honestly the first I've heard of it. I'm involved in social media with Kaweah Delta. Haven't heard anything about it. So if they're trying to get the community involvement and get their opinions, I think they've done a pretty poor job at it. I'd be really interested to see what the two different options are and provide any feedback.

Adam: Yeah. This is kind of the precursor to informing the public. So you would not necessarily have seen plans. You may have seen outreach from them to involve in general involvement, but not necessarily this stuff, ██████████ anything stand out here to you?

██████████ No, none in particular.

Adam: Okay. ██████████ you have some thought.

██████████ To be honest, this seems very superficial to me, it seems like a businessman specific or board members specifically wrote this up within size next 50 years, and it wants a community, if you're talking about the next 50 years, why aren't you reaching out to high school students? Why aren't you reaching out to college students? Many of them are of age to vote. Then also too, it says; "Let's talk about hospital beds. Let's talk about hospital rooms, what about patient care? If you're saving money? I would like to know where that money's going. What's the intended plan". I feel like this is kind of setting up a strategic plan, but it's not giving me any of the strategic details. So I would really like that. Especially if you're asking for team members help. You are really kind of hiding all of this stuff and not getting as much to go on, so how can we make an informed choice?

Adam: Okay. Obviously this is two paragraphs. If there is a plan, I think it will be very open. This is just kind of basic information, but what do you think that they should be doing with high school kids and college kids?



Probolsky Research
100 Pine Street Suite 1250
San Francisco CA 94111

San Francisco (415) 870-8150
Newport Beach (949) 855-6400
Washington DC (202) 559-0270

█ If it is saying community outreach, to be honest, the only community outreach that I've even received or heard about it. I was very involved at college quiz and very involved at Fresno state right now, the only outreach I've seen is commercials.

Adam: Oh, █ I think we lost you.

Adam: All right. We'll get her to come back. Hopefully. So anybody else, any other thoughts on this, █

█ I guess it is never par for the course that any time you go into something like this, that's so important, and as part of the community want to be proud of a hospital that's state of the art and modernized and all those great things and beautiful and something that you're proud of it within a city to have, like a lot of cities have in the country, but yet here, we've got to try to go through and get one that's built the cheapest and take the short path to appease the voters to say yes to something that's so important that, like I said, that when you're sick, I don't want to have some hospital that doesn't know what they're doing.

Adam: So you feel what you just read here is the short path.

Adam: Anybody else agree with that?

█ They are trying to get around from what happened last time. Obviously the voters voted it down because of cash and not thinking long-term.

Adam: █ what's your thought?

█ I just had a comment about how they chose someone that work at the Marcet hospital. I would just want to know as a community member here, how the community there reacted after it was built, did they like it? how was that now, prior to the voting and now that they have a bill, how do they feel about it? That way we know what we have to look forward to as well.

Adam: Okay, █ you had a comment also.

█ Yeah. Something about this, just kind of underscores the whole issue you brought up before about the Cleveland clinic connection. That's a financial arrangement to be branded with that name. If there's true clinical integration, you would think they'd have a place at the table about how they're going to make a whole new hospital building. So it just makes you kind of cynical to talk about these national affiliations when they brand



Probolsky Research
100 Pine Street Suite 1250
San Francisco CA 94111

San Francisco (415) 870-8150
Newport Beach (949) 855-6400
Washington DC (202) 559-0270

you in a way that's to your advantage, then when you really need help, you're on your own.

Adam: Okay. Fair enough. So we're going to move on and look at some hospital rooms. So the current patient rooms in the Mineral King wing are pie shaped and not conducive to positive patient experience. They're cramped at 118 square feet, they lack space for visitors and modern healthcare equipment. Patient beds are up against the wall, which limits access to a patient and limits the number of staff who can help a patient. The Acequia wing patient rooms are a bit larger and safer at 149 square feet and have limited space for visiting family and limited space for modern healthcare equipment. The proposed new wing, the ideal patient rooms would be consistent with current best practices in the hospital design, which included larger rooms at 175 square feet have proper bathroom experience. They have room for medical equipment safer overall, and allow family members to stay overnight with their loved ones. Any thoughts on these three different rooms? Anything concerning or aspirational exciting, or you don't really care? What are your thoughts, folks?

█ I definitely agree that the current rooms in the Mineral King wing are not ideal from experience and.

PART 2 OF 4 ENDS [00:58:04]

█ Well from experience and I don't know like, is that their opinion of what the ideal patient room is, or is that some sort of research that they've done or that I'm curious where the word ideal is coming from.

Adam: That's a good point. Yeah, I think this is what experts have developed as the more ideal scenario, but it's a good question. █ what do you think about these three situations? Any thoughts on that?

█ Yeah, I've also been in current patient rooms in the Mineral King Wing and they're just way too cramped. I mean if you have more than two people inside there, it feels like you're in a can of sardines. I like the next image because it does offer a little bit more room for equipment, but I also really liked the ideal patient bathroom just because it makes it more accessible for anybody who might be needing it.

Adam: Okay, anybody else? █ what's your thoughts on these different setups?



Probolsky Research
100 Pine Street Suite 1250
San Francisco CA 94111

San Francisco (415) 870-8150
Newport Beach (949) 855-6400
Washington DC (202) 559-0270

██████ Yeah, I've personally been in the Mineral King, very cramped, doesn't make for a memorable experience. You're kind of visiting someone you kind of quickly go away. And yeah, I just wonder what the ideal patient room, how many rooms are we possibly missing out on? Or could we have [crosstalk 00:59:33] a hundred more square feet... it's twice the size of the original. It sort of looks like as far as the total room area.

Adam: Okay, any other thoughts? ████████ you have any thoughts on this room setup? Which one? Different ones.

██████ Well, I'm thinking that showing this would be one way to sell a bond, this is what we have now, and this is what we're looking at. It allows more room for moderate equipment, allows family members to stay overnight, et cetera. All those things are really positive and might make a difference to people.

Adam: Raise your hand if you think kind of showing Mineral King versus ideal patient room, if that's compelling to you, if you think it would be compelling to other people to want to be able to build a new hospital. One, two, three, four, five. It's pretty much most people except for ████████ Not compelling to you? Oh, it is okay, all right. Okay, so now we're going to talk about these two different options.

Adam: And before I get to them, I'll say there's two different options we're going to look at and with each option, option one and option two, there'll be two phases with any. So option one will have a phase one and phase two, and then we'll look at option two, which we'll have a phase one to phase two. So I don't want to get confused by that. Let's look at it first. I'll go through all of them first and then we can chat about it. So, here we go, so option one is two towers built in two phases. The first tower phase one, will be built and operated for several years before the second tower would be built or even started. This option gives Kaweah Delta the flexibility of the community needs change. For example, they could build the second tower larger or smaller if those needs change.

Adam: So you can see first tower, here's what you get with that, parking structure, pharmacy, a better cafeteria experience there. Who was it? ████████ or somebody that had a hard time getting a sandwich or something. And then, so this is the cost, right? And then that escalates over time as you build. And here's the other things along with it, an EIR is environmental impact report. So, there's the cost of it, the second story, the second phase, here's what you get with that. And it costs about 365 million. That's kind of the plan. Here's how it would look, right? You'd have first tower, second tower, parking garages. So option two is a single tower and let me explain that a little bit. The tower



Probolsky Research
100 Pine Street Suite 1250
San Francisco CA 94111

San Francisco (415) 870-8150
Newport Beach (949) 855-6400
Washington DC (202) 559-0270

would be built at one time, but the top four floors, as you can see, they'll be built as shells and they'd be able to be built out later floor by floor as needed.

Adam: So you can see here again, nine stories overall built, four of them shells. Here's all the different features of it and a cost of 440 million. And then you've got the second phase would be to fill in the various shell floors and at a cost of a little over \$100 million. You'd have the first one starting, as soon as 2026 and the second phase, 2036. And here's how that would look, single tower. So again, option one, two towers phased in over time and then option two with one tower with the stories built over time. So with that, I'll kind of go in between the two, raise your hand if you like option one better, one, two, three, four, five, six, seven, okay eight. All right and then raise your hand if you like option two better. One, two, three all right, why option two [REDACTED]?

[REDACTED] The overall price I think was a little bit lower for this one. And it also leaves more space to build in the future if we need to build a second tower or another tower in the future.

Adam: Anybody agree with that idea that it gives you more space to do something in the future? Raise your hand if that's something you thought about. Okay, [REDACTED], why do you like option two better?

[REDACTED] Because you can do most of the dirty construction now and be done with it. And then you just outfit the inside later.

Adam: Okay. [REDACTED] why do you like option number one better?

[REDACTED] I don't know why, it just seems kind of weird to construct a large building but like half of it is empty like the shell. I mean, I do agree with the points of, realistically to add on, to build above existing buildings and I like [REDACTED] point of having the space as well. I think it's just having just a vacant empty building that's kind of weird.

Adam: Okay, all right. Anybody else have a thought on the two options? Why they chose it? What attracted them to that option? [REDACTED], yeah.

[REDACTED] I think it would probably be better and possibly easier to start it all now, then they don't have to keep on begging people for money. Basically, let's have a plan and let everyone know, Hey, if we do this, we'll be set up for this many years, we can all be safe and healthy and we won't have to be asking you'd write more checks or trying to fundraise and raise taxes anymore. I know and the space thing also we only have so many



Probolsky Research
100 Pine Street Suite 1250
San Francisco CA 94111

San Francisco (415) 870-8150
Newport Beach (949) 855-6400
Washington DC (202) 559-0270

downtown areas. So that way if they would like to build a specialized something or more parking, I think doctors' offices, whatever is needed they'll have that space for that too.

Adam: Okay, [REDACTED]

Adam: [REDACTED] Why do you choose? Which one did you choose?

[REDACTED] Initially chose one, but now I'm leaning more towards two. If you could go back to one, I think I saw that the... yeah, it's going over current parking, which is kind of concerning. Because then parking is already limited there so where is everyone going to park? And then I do agree with what Michaela said about building up. And then also just the fact that it's [inaudible 00:09:07] done but the parking was something I notice as you're building.

Adam: Okay, [REDACTED] you have a thought? [REDACTED] you're muted.

[REDACTED] Oh, sorry. So for the first option, I'd feel like for the people that are willing to hop on board with the bond, it'd be hard. I feel like it'd be hard to get them to sell them the second option. Hey, give us all this money and you're going to get half of a construction, it's just going to be built there, but there's not going to be anything there. The first one gives them like their functionality right away, operational. And they could see that as opposed to okay there goes our money, we're going to see that in a lot of years down the road.

Adam: Yeah, [REDACTED]

[REDACTED] I think when you say in the future as need arises, I think that makes it more difficult for people to agree and it's difficult to start a construction that then you're basically saying, well, we'll agree on this later. Which is more difficult to do, I think when you have a community involved. And so I could just see in the future those floors remaining vacant for a lot longer than necessary, just because of lack of consensus on what to do with them or when. So I do like that it is more efficient with space, but ultimately the plan perhaps if they had said, "no, this is the phasing of each floor." and had that thought out beforehand, I think that might solve that, resolve that issue, but they would just need to think what to do. I don't think it's as [crosstalk 01:08:55] [inaudible 01:08:55]-

Adam: [REDACTED] brings up a good point. So there's one way of approaching it saying, "Hey, we're going to build this tower. We're going to leave the top four floors until we need them and we're going to build it out as needed." Or you could say, "here's our plan 2036,



Probolsky Research
100 Pine Street Suite 1250
San Francisco CA 94111

San Francisco (415) 870-8150
Newport Beach (949) 855-6400
Washington DC (202) 559-0270

2037, 2038". Does that meaningful you? One kind of provide some flexibility based on need, the other one gives you certainty hey, we're spending your money this way. Who says flexibility is more important and who'd rather see a specific plan? Who says flexibility? One, two, three, who says a specific plan? Okay, all right that's helpful.

Adam, I guess coming with number one, mainly because you know tech, everything changes. So, 20 years from now we could find out that building codes or layouts of hospitals need to change. Look what happened to airports after 9/11, we all thought airports were pretty much never probably going to change internally and they did. Look what COVID has done to probably restaurants and everything for the future, so I think if we could have this shell, this hospital that you're not using and find out that well, actually we can't use those floors because they don't meet certain criteria that we don't even know. It could happen 20 years down the road.

Adam: Okay, all right so paying for all of this, takes money, right? And so the need to update the hospital would cost half a billion dollars or more. Kaweah Delta does not have all the money to pay for this. And we need to raise a portion of the monies through a bond measure. As a public hospital, Kaweah Delta treats all patients regardless of their insurance and their ability to pay for services. Tulare County is among the poorest counties in California and has the highest percentage of patients covered by Medi-Cal, which pays hospitals the lowest rates. As a result, Kaweah Delta is paid much less than most hospitals in the state. Would you support or oppose a bond measure to pay for the updates needed? In general, would you support or oppose a bond measure to pay for the updates needed? Raise your hand if yes. Keep your hands up, one, two, three, four, five, six, seven, eight, nine, 10, 11, 12. Okay, we brought [redacted] on board, somehow she peer pressure or are you really on board?

[redacted] I think mine would be, with qualifications I just don't think throwing money at it. I think there are underlying issues that need to be also addressed. So this isn't [inaudible 01:11:39] all of a sudden Kaweah Delta is going to be this amazing facility if we just throw a bunch of money at it.

Adam: Okay, how do you think a bond measure would impact you or without any, you know, details or anything else? How do you think a bond measure would impact you [redacted]?

[redacted] It was just increase taxes by a little bit, or just increase taxes from my check. But I honestly wouldn't mind it as long as I know it's going towards something like building the hospital improving it, I'd be all for it.



Probolsky Research
100 Pine Street Suite 1250
San Francisco CA 94111

San Francisco (415) 870-8150
Newport Beach (949) 855-6400
Washington DC (202) 559-0270

Adam: [REDACTED] how would a bond measure impact you?

[REDACTED] I think more of the overall future of the hospital in terms of the economic pressure. I've been in systems where everything is about getting the bonds and the daily performance sometimes get neglected and everything is devolved into this financial discussion. So, it's just like anybody else who overspends on a mortgage. Is it the right thing to do or not?

Adam: Okay. [REDACTED], how would a bond measure impact you that you think?

[REDACTED] I probably really wouldn't notice it as far as the other property taxes and I'm a homeowner and I think I'll notice it somewhat. But it's as far as how that stuff gets worked out was mortgage and everything I don't really pay too close attention to, I think there's people that do own multiple properties and that's probably the thing. I know the city passed the... I don't know if it was 2018 or the recent one, like a sales tax increase. And I think they essentially presented that as 40% of people come to Visalia to shop. So it was kind of like taking this load off of actual Visalia residence where kind of other people were contributing. So I don't know if that's something they can do.

Adam: Okay, anybody else have a sense of how a bond measure would impact you?

[REDACTED] As [REDACTED] was talking, I was thinking our home values, right? We're all homeowners so our home values would potentially increase because we have a state of the art facility right here in Visalia.

Adam: Anybody else agree with that idea? Home values could increase because you've got a better medical facility, a better hospital nearby. Raise your hand if that makes sense to you. Okay, all right.

[REDACTED] Adam, I would just add also that they want to consider something else besides, do like a gas tax or something. You get so many people that come through the city, tourists that are going up to the parks or whatever. Why not try to pull a little bit of money out of other ways, besides just hitting in the people in the town?

Adam: Okay, okay so let's go through some numbers here and it's a lot of numbers. You saw some of them, but I'll get to talk through it a little bit. So option one, two towers approximate cost to fund the overall new facility and updates is \$684 million. That would be 319 million in phase one and 365 million in phase two, because prices go up over time. So Kaweah Delta would work with banks and other institutions to borrow as



Probolsky Research
100 Pine Street Suite 1250
San Francisco CA 94111

San Francisco (415) 870-8150
Newport Beach (949) 855-6400
Washington DC (202) 559-0270

much money as they could to fund the project and raise other monies with grants and other things. So that would mean that Kaweah Delta would borrow about half the money and would pay for 160 million of the first phase, taxpayers upon about 159 million, the first phase. And then a few years later, phase two would be started and Kaweah Delta would pay for 183 million, taxpayers would pick up the tab for about 182 million.

Adam: The total of the two bonds for the taxpayers would be \$342 million. The average property owner would pay an additional \$35.55 per year for every \$100,000 in excess value. It was actually very based on the time, over the course of the 30 years, but the average will be 300. So it could be as little as \$17 and which is \$67 a year per 100,000 but the average would be \$35.55 per 100,000. So that would mean a \$400,000 home value would pay \$142 a year on average, over the course of 30 years. Would you support this? Who says yes? \$142 a year gets you... Kaweah Delta pays part of it. So one, two, three, four [crosstalk 01:16:48]-

█ Hey Adam is that the whole district or is it just the city of Visalia?

Adam: The whole district. Yeah, everybody in the district, property owner \$142 a year.

Adam: Okay, anybody say no? It's okay you can say no. Oh, we lost █ all right █ do you say yes or no?

█ Yes.

Adam: Okay, so, all right, I'm going to go through the second one. So option two, right? The one tower costs about \$542 million to fund the hospital updates and facilities. Kaweah Delta would borrow about as much as they could, assuming again, they borrowed about half, 220 million would be response, would be paid by Kaweah Delta. And about 220 million in phase one would go to be paid by taxpayers. Phase two, sometime later would be an additional \$51 million paid by Kaweah Delta and another \$50 million paid by the taxpayers.

Adam: Total of \$270 million bond, so a little less than the previous one. Average property owner would pay about \$31 per year for every \$32 a year for every 100,000. It would vary between 25 or so dollars a year and 62 over the course of those 30 years but the average would be \$32. So you get a 127 or \$128 per year over the course of 30 years, a little bit less than the other proposal. Who would support this? All right, █ or anybody



Probolsky Research
100 Pine Street Suite 1250
San Francisco CA 94111

San Francisco (415) 870-8150
Newport Beach (949) 855-6400
Washington DC (202) 559-0270

who doesn't like this idea is it because of the option two and you don't like the one tower or is it some other reason? [REDACTED]

[REDACTED] I lost the words, sorry.

Adam: Okay, anybody else have a reason why they'd oppose the option two option? An option which is 127 versus option two, which is 135, any concerns over that?

[REDACTED] It might be just that I didn't like that option. I don't know [crosstalk 01:19:05] if you're asking which amount I prefer, that's a different question right there, but I didn't like that option, so I didn't want to do that.

Adam: Okay, all right. Does that... again, I want to gut check the concept right? If Kaweah Delta through revenues, through grants, through borrowing, covering about half and having the taxpayers pick up the other half. Is there a different scheme that you think might be a better way of doing it? Something else that might be able to... you might come up with your own head on how to accomplish the goal?

[REDACTED] Yeah, it seems like they're taking a mission impossible. I mean as you said, there's the Medi-Cal, the lowest funding, all these things that we just accept, we just swallow this stuff. And the state has visited those things upon us and we've taken it and now we're going to go fund our own way. It seems like there needs to be advocacy on different levels to get money, to fund things properly, to take care of human beings who live here.

Adam: What does fund properly look like? Where does the money come from Joe?

[REDACTED] Well, I mean there has to be an innovative way of looking at the costs of medical care, given the demographics that use this hospital and the state should allow the money in a different way in order to equalize that.

Adam: So, give me a sense, where would the money come from?

[REDACTED] From another county.

Adam: Okay, so Rich County resources would be directed to Tulare because they've got the resources. Okay, all right... so yeah.

[REDACTED] I don't know when the right time to say this is but I think for me like when you're asking, would I be on board with this option or this option when it's just coming down to



Probolsky Research
100 Pine Street Suite 1250
San Francisco CA 94111

San Francisco (415) 870-8150
Newport Beach (949) 855-6400
Washington DC (202) 559-0270

numbers. And honestly, maybe it's just I have my background is just in teaching and so I deal with kids and if I want them to buy in, not with actual money, but buy into something I have to sell them and make them confident that what they're buying is worthwhile. And I think, we've kind of said earlier that some people don't feel as confident with Kaweah Delta. I think for me personally what it would take was them selling me on their vision and what they care to do with this before I would ever even think about consider voting yes on any of these issues. They'd have to sell me in their confidence. They'd have to give me a vision of something. I think in a clearer way than they have. So I don't know when that's supposed to happen.

Adam: So you just hit on the next topic and you're going to do it. So you're the marketing professional who is going to not sell the bond because government agencies don't sell bonds or government agencies can't advocate for a bond. They can put it on the ballot and say, "here's what happens if it passes, here's what happens if it fails." But they can't advocate for it, but let's say you're the outside a person. You decided this is your passion, you want everybody in your community to support the bond and support this project. How would you sell it? How would you tell your friends and family and colleagues about this and get them excited about it?

█ You actually asking me?

Adam: I am, █ Go for it.

█ I don't have a medical background, so that's hard to say. I think though anytime you're selling something, you want to show the support of the people who work there. Like I don't know the people who work at Kaweah Delta, would feel. They would like I'm sure working in new facilities, but I don't know if they... like do they feel valued as employees? Are they turning around and saying, I think like my first step as the CEO and the people in charge of Kaweah Delta would be an internal look and innovation in terms of like, how do you get these people that are working here passionate about this idea? And then once you get your team on board, then it just almost sells itself, I think. Then you have the support of the people of the community, because they're going to experience that with their visits there. I don't know if that answers the question.

Adam: █ what are you going to tell your friends and family about this conversation about the future of the hospital? What would you tell them based on what you heard tonight?

█ I would say that, so it's trying to sell them on it and say that later it'd be providing more jobs, making conditions a lot better for the hospitals that they would see if there's any



Probolsky Research
100 Pine Street Suite 1250
San Francisco CA 94111

San Francisco (415) 870-8150
Newport Beach (949) 855-6400
Washington DC (202) 559-0270

statistics on mortality rates. They'd be like, "Oh it'll go down." That the facilities will be better, more improved, cleaner, just letting them know, Hey, that this is beneficial for the community and these are all the reasons why.

Adam: Hey, [REDACTED] brings up a good point. Let's say this is going to create 500 local jobs, this process, right? Is that compelling? Is that something we talk about? Bringing new jobs when it comes to this thing, raise your hand if that's a compelling thing for you. One, two, three, four, five, six, seven, eight, nine, everybody but [REDACTED] and maybe he is a yes, we'll see. All right and [REDACTED], what are you going to tell your friends and family, when this subject comes up about the idea of a new hospital? Modernization, all this, what's your message to them about this? You're on mute [REDACTED].

[REDACTED] There we go, okay. So a lot like [REDACTED] was saying, just making sure that it's not that we're throwing money into it.

Adam: Forget that part, what are you going to tell them? What are you going to say? This subject comes up, two months from now, you're sitting at dinner and someone says, "Hey, I hear they're doing something with the hospital." And all of a sudden, you remember what you heard, what are you going to tell them?

[REDACTED] I am optimistic, I would hope that this is going to bring in more jobs for the community. I would hope that it would increase productivity and to make our community feel safer and be able to feel more secure when we do have emergencies.

Adam: Okay, [REDACTED] what are you going to tell people when this topic comes up?

[REDACTED] I say this lightly, but I guess I would tell if you're really ill sick, you have to be in the hospital let's say for weeks and weeks, would you rather stay at the Roach Motel or the Four Seasons Hotel?

Adam: Okay.

[REDACTED] Where would you rather be? The hospital is not getting any newer and every year that goes by, it gets older and older and older. And if we don't act now, it's not going to get any better.

Adam: All right, [REDACTED] what are you going to tell people when this subject comes up?

[REDACTED] I think it's needed. We have to have it or else the state could close down the hospital potentially. So I think it's just the way, depending on how the hospital district decides to



Probolsky Research
100 Pine Street Suite 1250
San Francisco CA 94111

San Francisco (415) 870-8150
Newport Beach (949) 855-6400
Washington DC (202) 559-0270

present the project to the public and the details of the funding, whether they're going to get the support or not, but bottom-

PART 3 OF 4 ENDS [01:27:04]

Whether they're going to get the support or not. I mean, but bottom line is it's needed. And I just, they just fixed the ER, I know they just opened it maybe several weeks ago. So I think it's, how it's going to improve specific people and their experience at the hospital. I think that's important and I haven't been in the hospital a long time, thankfully. But I think relating to people's specific experiences and improving these.

Adam: Okay. what are you going to tell people when you, the subject comes up?

I will probably kind of do just something like this, how I'll ask for their opinions as well. I'd be kind of be curious what other people think about even if I'm not like doing research. I would just want to know their opinions and how it might differ from mine and just get other people's perspective. But I would pretty much tell them how I feel, like this whole little experience kind of got me to see how necessary this stuff is, for the security and the feel of trust in the community for this hospital.

Adam: what are you going to tell people about the hospital if it comes up?

I just think in life, most of the time we think about the future. Like we pay car insurance, we pay regular insurance for the future. So why wouldn't we pay for a hospital in case we need it in the future. And also to, I could just tell my own story. If I, someone, before we decided to build a hospital, someone decided to become a nurse at the hospital and they treated me, and that's why I'm alive today. But that might not be the case for someone in the future, if the hospital closes and what if that's your grandchild? What if that's your son? What if that's your father? So it's needed and it's necessary and it [inaudible 01:28:41]. I mean, that's how I would [said 01:28:43] it. Even the cigarette commercials, I still remember that girl with a hole in her neck and I've never forget it because it was so stark.

Adam: Okay. what are you going to tell someone when this topic comes up?

Like other people have been saying it's a necessary thing for our community to update our hospital. It's old, it's outdated, we need the new facility. It's great to have state of the line buildings and modernized healthcare facility in our own backyard. It's going to increase our home values and it's only going to be about \$150 a year.



Probolsky Research
100 Pine Street Suite 1250
San Francisco CA 94111

San Francisco (415) 870-8150
Newport Beach (949) 855-6400
Washington DC (202) 559-0270

Adam: Okay, anybody else? [REDACTED] what would you tell people about that hospital in the future, if this came up?

[REDACTED] Well, it's pretty obvious we need it. We don't have a choice, but at the same time, I agree with what [REDACTED] says, that it's not that expensive and we got a better place to live. I think that's important.

Adam: Okay. [REDACTED] what about you?

[REDACTED] I would tell them, "Hey, remember COVID whenever there are so many people in the hospital we couldn't get surgeries done, or people couldn't even have knee replacements, or they were worried about people being able to come to the ER for other necessities like heart attacks". You know, we need a bigger hospital to keep on helping our community. That's just how it is when the community has grow you have to have them grow with you.

Adam: [REDACTED] you have another thought?

[REDACTED] Yeah. Also considering how Tulare's hospital is and how they've been dealing with, I guess they're the boards of directors and now it's closed down. Having something like Kaweah Delta being improved is beneficial for not only the people in the district, but how in the map, outside the district. So like Tulare people who need to come up to Visalia to get the treatment, it's great that we are updating the hospital.

Adam: [REDACTED] What are you going to tell people if the subject comes up?

[REDACTED] I would tell them that it's a new and improved hospital. Of course there are some [deployments 01:30:59], new and improved equipment technology and a better community. When there's a hospital that is treating everybody properly. And new improved technology like I said, it helps with the community.

Adam: [REDACTED] how about you? What would you tell people?

[REDACTED] I'd probably just say it's a necessary thing. It's pricey and it's not going to be done, they won't start for five years and it won't be done for 10 years. So, that's kind of a bummer as far as, I also don't know if they're using local workers, contractors. I don't know if the architect is local. So I would think for the messaging, if you can kind of say, so if it does take four or five years, I think most of us, most people in Visalia [cynically 01:31:57] say something it's going to be done by 2030. [Well 01:32:00] just assume we're probably



Probolsky Research
100 Pine Street Suite 1250
San Francisco CA 94111

San Francisco (415) 870-8150
Newport Beach (949) 855-6400
Washington DC (202) 559-0270

done like 2031 or 2032. And then, and if, I would assume if I'm a person, like an elderly person, I probably wouldn't go for it because I don't think I'd be around, so.

Adam: [REDACTED] what would you tell people?

[REDACTED] If you want Kaweah to be a player in the future, then this is the cost of doing business.

Adam: Okay. All right. So there's two, several, but there two kinds of schools of thought. Like, "Okay, we have this plan, we're ready to go, costs go up over time so let's get started. Let's do it now". Like in 2022, right? You'd see something on a ballot or, "Hey, we're just getting through COVID, I don't know how things are going. Maybe put this off a few years". Raise your hand if you're get started now. One, two, three, five, everybody. Anybody want to change it and say, "No, let's put this off for a few years and let's see how things go".

[REDACTED] It seems like a golden opportunity. Healthcare is in the news every second.

Adam: Okay. All right. Let's look at, last thing I'll share with you here is a little bit about the finances of Kaweah Delta. So revenues right now are \$734 million a year for the healthcare district, for the hospital and the district.

Adam: They receive 1.2 million in property taxes a year. So that's pretty, very small amount the property taxes that come from the district property owners. And then 3.1 million that's paying back Measure M Bond, which was 2003. So again, very small number compared to the cost of \$1.8 million a day to operate the hospital, to operate Kaweah Delta. And the district has approximately \$60 million in losses related to COVID 19. The district also has \$316 million, about 176 days of operating capital on hand. District resources be able to provide this world-class care, maintain modest improvements in the facility, that's pretty much what they've been able to do. They don't have the revenues or the resources to build the new hospital and modernized, which would cost hundreds of millions of dollars. Anything stand out to anybody in this situation? Anything surprising there?

[REDACTED] Can you break down the Measure M to how much that is per year, per person or?

Adam: Well, I mean, if the other ones are \$300 million and they're \$140 a year, how about a whole lot less than that. I mean, how about-



Probolsky Research
100 Pine Street Suite 1250
San Francisco CA 94111

San Francisco (415) 870-8150
Newport Beach (949) 855-6400
Washington DC (202) 559-0270

What I mean is how does that compare to what we're facing with this new bond? We have a new bond.

Adam: Yeah.

Is it going to be 3.1 million a year or is it going to be 5 million a year? You know, [crosstalk 01:35:12]

Adam: Well, it's going to be enough to pay for the facility. It's going to be enough to pay the contributing part of the-

You already said it would be \$615 million. So you know, how much does that per year? That's all I'm asking.

Adam: Okay. Well, I don't have the math in front of me, but it'd be enough to pay for the contributing part of the taxpayers. So here's a question, 360 million cash on here. They're sitting on bank people, right? They're sitting on \$360 million, and now they're going and asking you for cash to pay for a new facility and modernize your facility. Is everybody okay with that?

Adam: Anybody concerned that, what are you thinking?

Well, as a business runner myself, you have to have money in your bank to keep your business going. So that doesn't mean they're like bankrolling and stuffing the money under the mattress. I mean, they have to have money to keep paying their normal bills, just like you and I do. But just like, if you want to add on to your own house, you still have to have your money to keep paying your insurance, your electric bill, while you're doing, adding on that man cave or whatever you're adding on to your house while you're doing that too.

Adam: Alright. Okay, so brings some good point. Right, having reserves is important. They're a hospital, you want them to have resources around. But you know, most Americans don't have 176 days worth of operating capital. Adrian, does that worry you at all the way they're asking me for cash and yet they got cash in the bank?

Adrian: No, Because I was just thinking from like a practical standpoint. I mean, look what happened with COVID and if they weren't, if they have those reserves for, something that were to happen again, we would hope nothing like that again happens. But I'm sure when COVID hit it impacted their revenue by substantial amount. So I would think that



Probolsky Research
100 Pine Street Suite 1250
San Francisco CA 94111

San Francisco (415) 870-8150
Newport Beach (949) 855-6400
Washington DC (202) 559-0270

having that amount of money is just something, that's a good idea to have in case something else. Another emergency happens where they need to pay for the cost of operations without as much inflow of money coming in.

Adam: Raise your hand, if you disagree with what [REDACTED] just said. Okay, so let's, we're close to wrapping up here but we've got a few more things to cover. How do you feel about people who use the hospital facilities, but do not live within the boundaries of the district? They still get a bill, right. So, I mean, again, I can go there, or somebody from some place just outside the border can go there. People within the district can go there. How do you feel about people coming from outside the district and using the hospital facility?

[REDACTED] I would say it's fine to tell, I need one of those beds.

Adam: Okay. So, what would be the alternative of just like checking people's papers and seeing if they live within the boundaries and if they don't, tell them they can't come.

[REDACTED] No, I'm not saying that at all. I mean, I think that you just still need to keep it an open door. Because again, with COVID whatever, when you need to lean on another hospital, we'll be able to go to Fresno or whatever. You got to have that just for the well being of everyone, but.

Adam: Alright. [REDACTED] how do you feel about people from outside the district, those boundaries that I showed you earlier using the hospital, your hospital?

[REDACTED] I think the hospitals are for people and I don't care where they're from. I would also hope that if I were somewhere else, either visiting or that people would also feel the same about me. Yeah, I have no problems with that and I assume that they're paying taxes and things for other purposes.

Adam: So [REDACTED] brings up an interesting point. So everybody's paying taxes in their respective place. People in Kaweah Delta healthcare district are paying though for this hospital and those other people aren't paying for this hospital. Kind of interesting maybe to consider they're doing it in other places. [REDACTED] how do you feel about people outside the district using your hospital?

[REDACTED] It's fine for our specific need or situation. The only thing I was thinking about is if a bunch of people are coming from a different district and using Kaweah Delta, and yet that district is paying to increase a capital cost, to increase the size of the hospital. For



Probolsky Research
100 Pine Street Suite 1250
San Francisco CA 94111

San Francisco (415) 870-8150
Newport Beach (949) 855-6400
Washington DC (202) 559-0270

instance, when Tulare hospital was shut down for a long time. I'm sure all of the people that would usually go to Tulare were coming to Kaweah Delta. So, should Tulare have been incorporated in Kaweah's district to help that people in that area pay for Kaweah district. Now that it's back open probably not an issue, but if had that been a much longer term issue, then that would be a different conversation.

Adam: Those are one of the arguments. Again, [to measure age 01:40:37] a couple few years ago was this idea that outside the district boundaries, they were coming into use your hospital, and they're not paying the property taxes to cover that bond or in this case, some future bond. We've now solved that problem and we now are okay with it because we understand how the business model works, or we just now collectively we're all in this together because of, we see that because of COVID, or is there still a little bit of like, "Hey, I'm paying this tax because I own a home here and those people aren't". Anybody feeling that sense a little bit. Anybody think that, even their neighbor or someone they know might be like, "hold on here". You know, I'm not sure.

I wouldn't be opposed to charging somebody an extra entry fee. If they're from outside the area to come and use our facility. I don't think there'd be anything wrong with charging some extra saying, "You're not paying taxes to build this facility. We're going to charge you a sort of entry fee for your contribution towards using our facility". But trying to extend the borders doesn't really appeal to me. I mean, it needs to be done, and if we're within the borders and the bill at the bond comes now we need need to vote. Yes.

Adam: All right. you have an idea?

Yeah. I mean, this is not a carwash. People don't want to use the hospital unless they're having a baby, I would expect. And if there were any way to have a bond to more than bill the hospital, you'd got my interest there, have a better wellness center, do other things that make Visalia healthier, another in and out burger, another Dutch brother's coffee. I mean, what are we doing as a community? To me, I mean, incorporate some of that into the bond to make this area healthy and then we'd benefit from that because we live here.

Adam: Okay. Now, you know brings up a good point. I will say your bond measures, they can only pay for structural technology kind of stuff. You can't pay for services through them. But it's, I think a good point. You can kind of play up the things they're doing. All right. So, let's [all 01:42:59] talk about much of the advanced care available at Kaweah Delta. Heart surgery, open heart surgery, neurosurgery, cancer care would not be



Probolsky Research
100 Pine Street Suite 1250
San Francisco CA 94111

San Francisco (415) 870-8150
Newport Beach (949) 855-6400
Washington DC (202) 559-0270

available at Kaweah Delta if the hospital didn't serve patients from outside the healthcare district. Because you got a big pool of people, with people coming to use those services and by those services. When people from outside the district seek care at Kaweah Delta, the bills they pay help to support additional services at the hospital. Does that make sense to you? Right before we were kind of talking about maybe them being detractors, but the reality is the people that come in from outside the district are a part of that whole structure paying the bills for those advanced cares. Does that make a difference? Does that mean to you, [REDACTED] Yeah.

[REDACTED] Well this kind of relates, I had a follow-up question to the previous question. Because it seems like in Fresno a lot, like the Clovis area, those facilities are sought after, by a lot of people not in those counties. So I'm curious because what it seems like is Kaweah Delta has this you know, it seems like people are upset about people coming in from outside the district. And yet in those Clovis areas that's happening all the time and yet they don't seem to have the issues with poor reviews and that. So I'm curious what the discrepancy is there and I don't know if that's necessarily. Yeah, just that people are coming in from outside those districts. So that's kind of a follow-up question. I don't know if you would have that data available.

Adam: Not particularly but valid question. Anybody else? Yeah, [REDACTED]

[REDACTED] I guess it would be interesting to see how other hospitals handle it, because it already happens nationwide and worldwide. When you think about New York city where there's maybe hospitals that are from expertise is cancer or whatever. If someone's got a major illness, a lot of times they want to go to LA or bigger, better hospitals than [inaudible 01:44:58] so.

Adam: Okay. And anybody else have a thought about the fact that people from outside the district contribute to the overall ability for the hospital to have those advanced care. Does that make sense? You know, go ahead, [REDACTED]

[REDACTED] I just had like a question about that. So if, it seems to me based on the map that along the outside districts are usually more in the rural areas. So if the majority of those are on Medicare, how much revenue is really helping towards the hospitals? Since then you say they get a less amount for the hospital if it's on Medicare.

Adam: Yeah. Okay, good. It would be good to maybe see those numbers, how they line up. Okay. Last subject, I want to bring up, we'll talk about one of the thing. Kaweah Delta has met with surrounding healthcare districts to do, that do not have hospitals to



Probolsky Research
100 Pine Street Suite 1250
San Francisco CA 94111

San Francisco (415) 870-8150
Newport Beach (949) 855-6400
Washington DC (202) 559-0270

discuss merging healthcare districts or evaluating options that would allow other districts, residents in other districts to help support Kaweah Delta's building and replacing the facility. How do you feel about other healthcare districts consolidating with Kaweah Delta? So basically Delta's boundaries, growing to include the residents and the voters in those areas, property owners in those areas, paying taxes towards Kaweah Delta. Any thoughts about that?

██████████ I think we're talking about the Exeter and Lindsay. That's two of them that have had hospitals in the past, but don't anymore. And I'm certainly in favor of them if they want to join in Kaweah Delta. And, I mean we're a regional hospital that does attract people. I know, you know, anyone who gets in trouble in Porterville is not going to spend much time in Porterville hospital, they're coming up here. So, we want to capitalize on that, on the fact that we are the regional big guy. Although many of our people may go to Fresno or San Francisco or something, we are for this area, the big guy, and we need to be inclusive rather than saying, "Well, you're just going to get taxed more". No, we need to include you. You need to be included in this because you get the benefit of it.

Adam: ██████████ what do you think about growing the borders of the health care district and having the property owners in other parts of the county help foot the bill?

██████████ He made a great point. We are somebody's Fresno. We are somebody's Clovis hospital. So, just increasing other people who are contributing to our hospital would be beneficial.

Adam: Anybody else have the concern over the possibility of growing the boundaries of the health care district. It's kind of like, kind of like taking, growing the size of a city, right? In this case, it's a healthcare district. We're bringing in a different group of people, they're paying part of the taxes, but there's some of you they're also electing your board members. ██████████ yeah.

██████████ I was just had the concern for the specific bond, because a lot of these are rural communities. And if you present this, like the amount that they be paying became for your [inaudible 01:48:10] is less than what they normally pay like per month and car insurance. But it's just another sum that they're going to think of. So I feel like if we included them prior to passing this bond, it might result in the bond failing. However, if you include them after passing the bond and be like, "Hey, you're in this district now, this is what you kind of agreeing to". Then I feel like it can be beneficial.



Probolsky Research
100 Pine Street Suite 1250
San Francisco CA 94111

San Francisco (415) 870-8150
Newport Beach (949) 855-6400
Washington DC (202) 559-0270

Adam: Interesting, anybody else share that concern? If you were to say, grow the boundaries, the district in 2021, and then you have a bond measure in 2022. Your more rural populations might be less likely to vote, yes. And that might hurt the chances of a bond passing. Is that a consideration for anybody? [REDACTED]

[REDACTED] I agree with [REDACTED] after I thought about it. Because I [inaudible 01:48:58] I lived in Springville and Porterville area and they don't like I say very much. Can say, you go out to Lindsey and Exeter and you ask him to join us. Well, if it costs money, thanks. You know, I can use the hospital anyway, I don't care. So I really think [REDACTED] has a good point there.

Adam: [REDACTED] what were you, you're nodding.

[REDACTED] Yeah, I agree. I think that the distance just to drive into Kaweah Delta and the fact that they're just a little bit farther radius from Kaweah Delta, they're going to say "No, no, no, that's not my area. I don't want to pay for that". You know the people who benefit from the home value increase, they should be the ones who are paying for that.

Adam: Okay. Yeah [REDACTED], go ahead.

[REDACTED] We have to rethink how we deliver care because it's not all about coming to the hospital. You know, the hospital needs to integrate in the community and a counter to that other argument is we bring services to Porterville, we bring services to Lindsay, whatever you want to say, but you can't be arrogant about saying everybody has to come here to get healthy.

Adam: Okay. All right.

[REDACTED] I believe [inaudible 01:50:10] open a clinic in Exeter recently in the last year or so.

Adam: Yeah. There are other, there are clinics all around. Okay, what didn't we get to tonight? What was like the topic that you're like, well, why the hell didn't we talk about dot, dot, dot? What didn't we talk about that we should have talked about tonight? Yes. [REDACTED]

[REDACTED] Just marketing in general. I'd be curious on what marketing strategies you all would respond to do. I know personally I liked the commercials and the testimonials, but I just would be curious to what would convince you.

Adam: Okay. Anybody else, what didn't we get to tonight? Nothing on your mind that we should have flushed down?



Probolsky Research
100 Pine Street Suite 1250
San Francisco CA 94111

San Francisco (415) 870-8150
Newport Beach (949) 855-6400
Washington DC (202) 559-0270

█ I had a thought at one point, you mentioned how or somebody mentioned how everybody is a taxpayer from somewhere, but what about non taxpayers who walked through the doors of the hospital?

Adam: Give me example of who is a non taxpayer.

█ An immigrant who is living here on a visa or not working here.

Adam: So he doesn't pay property taxes.

█ Property taxes, Correct.

Adam: Or maybe income taxes, but they would still pay sales tax. Right?

█ Sure. But those aren't going to be going directly towards this measure.

Adam: No. And neither does income tax either. So it's really just, it's essentially, this is about the tax, [crosstalk 01:51:39] the tax will go to property owners, right. Because you also have some people with some pretty big landowners. Yeah. I don't know where █ grows his stuff, but he may be a little bit more impacted than the rest of us, because big property owners could have to pay a little bit more. Yeah, go ahead, █

█ I just wanted to know one thing, would this at all go towards like the people that are actually working. So like with the bond helped them get a salary rate, a wage increase or anything like that?

Adam: No. So bond just, I mean, I don't normally answer a ton of questions in programs in sessions like this. But, no bonds can only pay for facilities and like physical things, technology upgrades and things like that. It can't go to salaries or, I mean, obviously you don't pay for the salaries of the people building the facilities, but it can't go to like doctors or something like that. Yes, █

█ One thing I kind of wished we kind of went more into depth was the percentage of what the bonds going to go towards, like the facilities versus the equipment, like what percentage is going to what, and just to see where the money is actually flowing.

Adam: █
█
█
█



Probolsky Research
100 Pine Street Suite 1250
San Francisco CA 94111

San Francisco (415) 870-8150
Newport Beach (949) 855-6400
Washington DC (202) 559-0270

[REDACTED]

[REDACTED]

Thank you, Adam.

Adam:

Goodnight.

[REDACTED]

Goodnight

PART 4 OF 4 ENDS [01:53:42]



Probolsky Research
100 Pine Street Suite 1250
San Francisco CA 94111

San Francisco (415) 870-8150
Newport Beach (949) 855-6400
Washington DC (202) 559-0270

Group 4

Adam: Good evening. Welcome to our discussion group. Thanks for taking the time to join us. I am Adam Probolsky. I'm in a research company here in California, and we're here to talk about healthcare in Tulare County, and we'll get some more detail in a minute.

Adam: You were invited because you live in Tulare County, some total of your qualifications. This is just for research. No one's going to follow up with you, other than sending you an incentive. There's nothing else, no follow up or anything like that and [inaudible 00:00:35] sell you anything. I'm certainly available for questions afterwards. We will be recording tonight, because I can't take notes that quick and we're on a first name only basis. Everybody can acknowledge that they're okay being recorded, that would be great. Say yes or thumbs up or anything like that.

[REDACTED]

[REDACTED]

[REDACTED]

[REDACTED]

Adam: My goal is to have a kind of open discussion, a frank discussion. No one dominated the conversation and there's no right or wrong answer. Feel free to share whatever's on your mind. Negative comments are just as good as positive comments for us. If you disagree say I disagree and say why and same thing for agree. My role is not to express an opinion, but I may bring up ideas to see what you think about them and I may move the conversation along if I need to, because we've got a lot of content to go over.

Adam: So let's go around the group and let's just say your name the way you like it to be said and something about yourself in six seconds or less. I'll start, I'm Adam and I have my first plane ride in June, coming up late June since I haven't been on a plane in more than a year and a half. Karen, how about you?

[REDACTED] I'm [REDACTED] and I'm retired. [REDACTED]

Adam: Right, [REDACTED]

[REDACTED] [crosstalk 00:02:11] just finding out new things.



Probolsky Research
100 Pine Street Suite 1250
San Francisco CA 94111

San Francisco (415) 870-8150
Newport Beach (949) 855-6400
Washington DC (202) 559-0270

█ Yes, I'm here.

Adam: But do you have your video or no?

█ No, I have to connect through my phone.

Adam: Okay. Did you do that yet?

█ I'm working on it.

Adam: Okay. All right. █ is your audio better? █ you're muted.

█

█

█

█

█

█

Adam: Who just said something? █ Okay, let's get started here. What do you know about Kaweah Delta or Kaweah Health? █ go ahead.

█ I've got a little bit of experience there. Both my husband and I have been there to the ER. I don't feel like I had a really positive experience there.

Adam: Okay.

█ I don't know much about the facility itself. I know they just recently changed their name.

Adam: Okay, fair enough. █ what do you know about Kaweah Health or Kaweah Delta?

█ Kaweah Delta they got the hospital downtown. I mean I've had service there, seemed to be okay. Generally we have our children go to their primary care, but usually if they have an emergency we send them to Fresno, up to Valley Children. But Really my wife has had all four of our children at Kaweah Delta. I don't really have any bad things to say about it.



Probolsky Research
100 Pine Street Suite 1250
San Francisco CA 94111

San Francisco (415) 870-8150
Newport Beach (949) 855-6400
Washington DC (202) 559-0270

Adam: Okay. [REDACTED] what do you know about Kaweah Delta, Kaweah Health?

[REDACTED] Familiar with the hospital downtown. I've been there a couple of times for lab work. Haven't had a whole lot of services done through Kaweah Delta. I hear mixed reviews about it from friends and family.

Adam: Okay. [REDACTED] what do you know about Kaweah Delta, Kaweah Health?

[REDACTED] Unmute, okay. Unmute, sorry. I don't know if I'm fair to speak on this, because I just lost my fiance. It'll be a year on the 11th next month and he was at Kaweah Delta, and I'm not very happy with them right now to say the least.

Adam: I'm very sorry to hear that.

[REDACTED] But prior to that, my fiance used to think they were a pretty good hospital. He used to take his mom there. Like I said, I've only been out here about nine years. I've never had any good services directly from them. I've heard mixed reviews too. Now I just call them [Killya 00:08:07] Delta, because I feel like that's what they did to my fiance, because they're understaffed or too busy or I don't know what.

Adam: Sorry about that. [REDACTED] what do you know about Kaweah Delta, Kaweah Health?

[REDACTED] I've never actually been into the hospital. I take my kids to Visalia Medical Clinic, which I know is run through Kaweah Health. They seem to do just fine. My husband actually works at Kaweah Delta sometimes. I know a little bit about what he does and I've talked to some of the moms that have delivered there and they liked that they had private rooms for recovery. They didn't have to share with somebody else and that's about it.

Adam: Okay. All right, and [REDACTED] what do you know about Kaweah Delta, Kaweah Health?

[REDACTED] I'm not too familiar with their medical services, I've never really used them before. Like everyone else I've heard mixed reviews about it. I use the fitness center they own. That's all I can attest to really.

Adam: All right. [REDACTED] how about you?

[REDACTED]

Adam: Better.



Probolsky Research
100 Pine Street Suite 1250
San Francisco CA 94111

San Francisco (415) 870-8150
Newport Beach (949) 855-6400
Washington DC (202) 559-0270

[REDACTED]

[REDACTED]

[REDACTED]

[REDACTED]

[REDACTED]

[REDACTED]

Adam: All right. Real quick, if anybody has anything to share of something you like about Kaweah Delta or Kaweah Health, raise your hand, chime in.

[REDACTED] I do.

Adam: Yeah, [REDACTED], go ahead.

[REDACTED] Well, like I said, since they opened the Urgent Cares in the last few years, I mean there's one right down the street from where I live, I love it. They know me because I've got two younger kids. So they're always sick with a cold or some kind of virus and I'd go in there and have asthma. They're quick, and that's what I love about the Urgent Care. I have to say that. Really I have to give them kudos, because I had an incident and a flare up, [REDACTED] From one Kaweah Urgent Care that was closed, they sent me to the other one and I was seen like that. So their Urgent Cares are amazing and that's what I love since they started opening those up. I go there rather than go to the ER any day.

Adam: Anybody else have a something they like about Kaweah Delta? It doesn't have to be healthcare. It could be some other part of what they do or how they operate.

[REDACTED] Oh, and the women's thing they did. They did a conference not too long ago on women's health and it was on virtual. That was a really good conference. I wish I could have gone in person, because sometimes they give a lot of nice little gift things, little band-aids, just giveaways. That's one thing that I really enjoy with them. I've gone to the National Women's Conference here in Visalia that they have in November, it's for migrant women and Kaweah Health does really good outreach there for them. They do the diabetes and all that. I really appreciate that they do that for the whole city every year. It happens in November.



Probolsky Research
100 Pine Street Suite 1250
San Francisco CA 94111

San Francisco (415) 870-8150
Newport Beach (949) 855-6400
Washington DC (202) 559-0270

Adam: Okay. Anybody else? Anything else they want to share?

█ Yeah, I would just add to that, that I like the fact that they're a huge employer in the city of Visalia.

█ Mm-hmm (affirmative), that's true.

█ That hospital basically almost supports the entire downtown. I mean, they're one of the reasons that our city has a great downtown and we totally support it [crosstalk 00:14:28] hospital.

█ That's true.

█ So I just think that's a really positive aspect of it.

█ That's true.

Adam: Okay, anybody else?

█ I agree with █ their Urgent Cares [crosstalk 00:14:32].

█ Mm-hmm (affirmative), yeah.

Diana: They were very efficient. During all this COVID time you could even do virtual visits right away [crosstalk 00:14:39]. That's very-

█ They were amazing on that.

Diana: And then Kaweah Delta with... My mother-in-law passed away. Every year they send out a mail on her anniversary death. [crosstalk 00:14:55]. They have reached out to see if we need to go to a support groups and stuff like that.

█ That's neat. I didn't know that. That's awesome. [inaudible 00:15:05].

Adam: Okay. Anyone who hadn't shared anything about what they didn't like about Kaweah Delta, Kaweah Health yet? If you're somebody who didn't share yet, anything you want to share that you don't like about Kaweah Delta?

█ My experience has only been with the ER.



Probolsky Research
100 Pine Street Suite 1250
San Francisco CA 94111

San Francisco (415) 870-8150
Newport Beach (949) 855-6400
Washington DC (202) 559-0270

Adam: Okay.

█ Personally, I'm a Kaiser member, but since there's no Kaiser near here, I ended up having a █ So I went in through the ER and they took care of me pretty quickly. I think they knew that they needed to do something quickly, but I was only there overnight and then transported to the █. They wanted to get rid of me as quickly as possible I think. But my husband has had more recent experience with the ER and there was just a long wait. Of course, they're busy and we tried to take that into consideration, but there was a long wait for him to even be seen or have any testing done or anything. A long wait for him to get into a room. I mean, I think at one point he was in the hallway. Again, they're busy.

Adam: Yeah. All right, I'm going to share with you some slides of information that we'll read. I want to go ahead and read it and then we'll chat about it here.

Adam: (silence).

Adam: Okay, let's go ahead. █ anything surprising, shocking, fascinating here for you?

█ I didn't realize that it employed that many employees. I knew they were a large employer, not in our city, but that 5,100 employees is quite impressive.

Adam: Okay. Anybody else?

█ It missed that they just recently built the helipad. Where's that in there? Did I miss that?

Adam: There's no helipad in this thing.

█ Oh, okay.

Adam: █ go ahead.

█ I didn't know that we had a renowned NICU and pediatrics center. That's great, because I mean we would go all the way to Fresno to the children's hospital and they know that we have a pediatric center right off of Acres. I see that, but I've never been there. But it's nice to know that that's in Kaweah.

Adam: Yeah. Anybody else? Something that surprised you in this information?

█ Yeah. I didn't know there was eight campuses that span the area at all.



Probolsky Research
100 Pine Street Suite 1250
San Francisco CA 94111

San Francisco (415) 870-8150
Newport Beach (949) 855-6400
Washington DC (202) 559-0270

█ Yeah.

Adam: Okay.

█ I agree with █. I didn't know about the NICU. That's a pretty hopeful sign for me.

█ Yes.

Adam: And what about the fact that it's owned by the taxpayers, that you own it? Did you guys know that?

█ That I didn't know. I didn't know that either. It says by the elected voters and I'm like, "Hey, I'd like to vote. I want to be on that or check that out."

Adam: Sure. Okay. All right, here's a map. The voters who live within the boundaries of the map, elect the Kaweah Delta Health Care District board members, the board of directors. And the people within the map pay taxes to the Health Care District. But of course, anyone can go to the hospital, whether you live inside the boundaries of the map or not. Any thoughts on this map?

█ No, you have all the surrounding cities, which is good. Ivanhoe to Goshen, corners of Farmersville, and [crosstalk 00:19:53].

█ Anything else █ you have something you want to say?

█ Yeah. Who covers outside this area? Who put the boundary on this [inaudible 00:20:04]?

Adam: I mean, there are other Health Care Districts. They don't necessarily have a hospital, but there are other agencies that voters can vote in.

█ But it seems to me that the boundary doesn't necessarily align with the community that it serves, what I would think.

Adam: Okay, fair enough. Any other thoughts? Okay.

█ Because it doesn't go all the way down to [Tulare 00:20:40], so just saying. Yeah.

█ Tulare has their own hospital.



Probolsky Research
100 Pine Street Suite 1250
San Francisco CA 94111

San Francisco (415) 870-8150
Newport Beach (949) 855-6400
Washington DC (202) 559-0270

█ Yes, and doesn't Porterville have one too?

█ Porterville has a hospital.

█ Yeah, and now Exeter's with us though, right?

█ [crosstalk 00:20:53].

█ Exeter is part of us?

█ Yeah.

Adam: Yeah.

█ Okay.

Adam: All right.

█ Did Tulare open back up?

█ Yes.

█ I thought they were closed down. Oh, they reopened?

█ They reopened.

Adam: All right. So bottom line question, do you trust Kaweah Delta, Korea Health? The medical care they provide, the leadership to tell you the truth, to always consider the best interest of the community and how they operate. Broadly, do you trust Kaweah Delta and Kaweah Health? █

█ I do.

Adam: Oh, █ says yes. Why don't you raise your hand if you say yes first and keep your hand up for me. One, two, three, four, five, six, seven. Okay.

█ Are you talking about Kaweah Health as a whole or just a hospital?

Adam: Yeah, in general.



Probolsky Research
100 Pine Street Suite 1250
San Francisco CA 94111

San Francisco (415) 870-8150
Newport Beach (949) 855-6400
Washington DC (202) 559-0270

█ Like the [crosstalk 00:21:39] system?

Adam: Do you trust them to tell you the truth? Do you trust their healthcare? Do you trust their leadership? In general, do you trust Kaweah Health?

█ Yes.

Adam: I've got two that didn't raise their hands. Susie, you can put your hand down. So Carissa, why would you say you don't trust them?

█ Personally because of, again, our long history.

█ Experience.

█ I actually was born and raised here in Visalia and then moved with the military and came back █. I worked with them on a professional standpoint as well and my aunt and two of my cousins that are nurses and █ they're at Kaweah. So professionally and personally, we've had such a long history of negative experiences with them and how they've handled situations. Some of the things that have been done, because of being here such a long time, and things that were chosen to do by the board and whatnot, and hearing from my family who has worked there for a long time about things that have gone on internally, hasn't left much of a positive... We have to use them anyways, because that's the only option we have other than driving to Fresno, but mm-mm (negative).

Adam: █ you're kind of very dark. I don't know if you can sit closer or change the angle so we can see you a little bit better. There's moments where it gets better. That's better, much better. Perfect. So █ I think I have a sense of it, but can you tell us why you don't trust Kaweah Delta?

█ So if I just base it on the one experience with my fiance and the 11 day stay that he had there, it would be very negative and very bad. But like other people said, "That's our hospital in this area. We kind of have no choice but to trust them." I mean, I still will go there. I guess I do trust them in a sense that I will go there, because I have no choice, but if I base it on my experience with my fiance and his stay that was there, it wasn't good. The doctor was telling me positive things, the nurses were telling me the complete opposite. █ So it was a lot of different mixed feedback. I



Probolsky Research
100 Pine Street Suite 1250
San Francisco CA 94111

San Francisco (415) 870-8150
Newport Beach (949) 855-6400
Washington DC (202) 559-0270

would think I would trust the doctor's opinion more than the nurses and they left me very positive when it was negative in the end. I don't know.

Adam: Okay. Everyone, when you think of the... I'm sorry, [REDACTED]

[REDACTED] He was also pre admitted by his doctor before he went in and they told him to just report to the urgency that [inaudible 00:24:32] admitting him. When we got there they had not done any of the paperwork and he wasn't able to even get a room till the next day around [inaudible 00:24:42] supposed to be pre admitted by his physician.

Adam: [REDACTED] we're having a little hard time hearing you and the camera's shaking. So if you could maybe keep it stable and be able to speak up, that'd be helpful. All right. So when you think about Kaweah Delta and who do you trust to tell you about the future of the hospital, the future of Kaweah Health in general? Do you trust the CEO of the hospital, an elected board member? Do you trust a nurse? Do you trust the media? Think of that one person and what they look like and what they're dressed like and what their position is that you'd want to hear from, that you would trust about the future of the hospital? [REDACTED]

[REDACTED] I'd probably say a combination of the upper management, the head doctor and maybe a board member.

Adam: Okay. [REDACTED] how about you?

[REDACTED] Yeah, I agree with [REDACTED] Definitely not the media. For sure a lot of biases in the media. But yeah, I would look for a combination of their leadership and consistency and in whatever their message is.

Adam: Okay. Okay. [REDACTED] what do you think of when you think of someone you trust to tell you about the future of the hospital?

[REDACTED] I would definitely say that a board member would be a good start for knowing about the future of the hospital itself. I feel like employees who work there kind of get a sense for what the hospital's planning to do also, just because we have experienced working in the hospital in my family. You kind of get a sense for what's going to be happening in the hospital in the future.

Adam: Okay. [REDACTED] when you're thinking about the future of the hospital, who do you want to tell you about that? Who are you going to trust to tell you about that?



Probolsky Research
100 Pine Street Suite 1250
San Francisco CA 94111

San Francisco (415) 870-8150
Newport Beach (949) 855-6400
Washington DC (202) 559-0270

██████████ I mean, hopefully it would be all leadership. They would all be honest and have a good perspective of the future. But I guess if I had to trust someone personally, it would probably be a board member too.

Adam: Okay. ██████████ how about you?

██████████ Well, I think you'd want to go back and check what the board said in the past and kind of look to see what they've actually done in the past and you can see if they can build that kind of trust with you. So they said they're going to X a couple of years ago and they've done that. You can go back and rely on them going forward.

Adam: All right. ██████████ who would you trust to tell you about the future of the hospital? The CEO, the doctors and nurses?

██████████ The board members.

Adam: Go ahead.

██████████ It would be the board members. I feel like I'll listened to the CEO. I would listen to what they have to say. I do probably put more weight in the board, because they are elected and I feel like as a result of that, that they act as better in between, because they aren't employed by the hospital. There's not fallback if they don't fall in line there, and because they were elected by residents in our county, I just feel like that would be the best. That's who I would look to.

Adam: Okay. ██████████, who would you trust to tell you about the future of the hospital? You're on mute right now. You're muted, Susie.

██████████ Oh, there we go. Can you hear me there?

Adam: Yeah. Good.

██████████ Okay. So I'd actually want a board member and nurse, and I'd actually want some supervisory capacity to talk to me, because I want a sense of all of it. You want me to trust you. I do, you're in my community, I'm going to use you. Yeah, board member definitely, chief of staff, a chief resident, or chief nursing supervisor as well. Put all the faces of Tulare there who worked there. I want to see you all. I wanted to trust you. Like I said, I love a lot of things you do, but I'm not going to lie, I get a little nervous I never have to go to an ER there, because the length of time, things that have happened and so forth. I'll go to the other place like the Cyprus Center and so forth.



Probolsky Research
100 Pine Street Suite 1250
San Francisco CA 94111

San Francisco (415) 870-8150
Newport Beach (949) 855-6400
Washington DC (202) 559-0270

Adam: All right [REDACTED] who would you trust to tell you about the future of the hospital?

[REDACTED] I would say the board members as well, because they're the ones that all talk about anything that's going to be happening and making the decisions and kind of know what's going on.

Adam: Okay. [REDACTED] how about you? Who do you trust to tell you about the future of the hospital?

[REDACTED] I agree with just about everybody else that I would trust a board member. I think they'd be the one to give you the straight story. I mean, they'd have their finger on the pulse of what was going on.

Adam: So what about the idea that board members they're elected officials, they're politicians, right?

[REDACTED] Exactly.

Adam: They got to raise money. I mean, what's the difference between the mayor or the council member or the board member or the Congress person?

[REDACTED] [crosstalk 00:29:41].

[REDACTED] You can vote them out.

[REDACTED] [crosstalk 00:29:43].

Adam: Okay. [crosstalk 00:29:43] you can vote them out.

[REDACTED] [crosstalk 00:29:45] short term.

Adam: What does that do for you? Maybe they won't lie to you?

[REDACTED] That won't do anything.

[REDACTED] I feel like there's accountability. I feel like they owe accountability to those who vote for them and being involved in advocacy and whatnot. I've seen that people have a voice-

[REDACTED] Repicci and whatnot. I've seen that people have a voice as voters. We have a voice, and if we see them going in saying they're going to do something and they don't follow



Probolsky Research
100 Pine Street Suite 1250
San Francisco CA 94111

San Francisco (415) 870-8150
Newport Beach (949) 855-6400
Washington DC (202) 559-0270

through, that, we at least can go in and as voters make the choice to continue to keep them there or not. As opposed to hired employees at the hospital who we didn't have any say in how they got there, they're hired and paid by the hospital.

Adam: Does anybody have any concern over the politicians? Right? The elected

█ I do!

█ I think that's why you want some people that are, that are at the hospital more longer term.

█ Exactly.

█ There's often there's board members. Yeah. They're there, but sometimes they're there for short-term time and they don't necessarily have the tenure to carry out a long-term road plan of the hospital, I also think that. Oh, go ahead.

Adam: That's great.

█ Could I just, Can I add, I feel like it's important to know that like a CEO's job is to steer the way that the business is going to be running in any corporation at all. And so I feel like the CEO is going to know what the direction is. That's going to be going in the hospital. But I also feel like a CEO has just as much of a tendency to spin as a board member. And that's why it comes to okay. A board member. I can say I'm not going to vote for you next time versus a CEO where the community would have to come out and be like, call them for their head. If they did something they didn't like, okay.

Adam: All right, I'm going to give you a two points of view. And I want you to raise your hand for whichever one more accurately reflects how you feel. So one point of view is can we adapt to it as just a small town hospital you go to because it's close. And another point of view is a Kaweah Delta or Kaweah health is the hospital you choose for complex care because you want to go there. So is Kaweah health a place you go to just because it's a small-town hospital and you got to, or is the place you go for complex care because it's the right place to go. So who says small-town hospital? Just because it's there. One, two, three, four, five, six. Okay. And who says, it's a place you go to for complex care? Cause you want to go there. One, two, who didn't, who didn't put their hand up, █ why don't you unmute yourself and tell us why?



Probolsky Research
100 Pine Street Suite 1250
San Francisco CA 94111

San Francisco (415) 870-8150
Newport Beach (949) 855-6400
Washington DC (202) 559-0270

Well, I'm just like, I'm on the fence on both of them because it's a small-town hospital and it's here and I'm going to have to trust them. But the other thing is it's like, I want to see a doctor or a nurse. If you're going to be changing the hospital. I want to see the people working. You know, happy employees are happy, or good workers. And sometimes a disgruntled employee. I have a job because I got the job and I'm working at it, but I want you to be able to take care of me. My, I'm giving you my life. I want you to take care of my child. I want you to really give me your attention. So is it as is? Yes, I do. It's here and I'm going to use it, but I'm not going to lie. I got my next season done in Fresno that's this year.

Yeah.

Adam: All right. So Kaweah Delta is affiliated with the Cleveland Clinic for cardiac care. It has the number one thing has the number one rated heart program in the nation. Kaweah Delta is the only hospital in California that Cleveland clinic affiliates with. How does this make you feel? Let's change, first? Who, knew that that Kaweah Delta, Kaweah health was affiliated with Cleveland clinic. Raise your hand if you knew that a one. Okay. So one, one person knew that anyone have a, does that evoke some response, any thought from you that, you know, does that make you happy? Sad? Kind of curious if we have a thought on that?

I'm not sure what exactly that means. Affiliated with them, what do we send patients there to give them advice on the daily. How does that help?

Adam: Okay.

Adam: It brings up questions to you. Anybody have any, make you feel one way or the other about Kaweah Delta, Kaweah health based upon the affiliation with Cleveland Clinic?

No. It makes me feel, yeah.

I think if, if it's the only hospital in California that Cleveland clinic is associated with, I think that's a pretty good affiliation. That means that somebody did a lot of hard work to get that affiliation. And that means that there's going to be research and money and information about the heart specialty coming to our hospital. And so that is encouraging.

Adam: All right. So let's think about financial medical resources. So I'm going to ask you, tell me why it's important to you. If it is important to you, that Kaweah health has the financial



Probolsky Research
100 Pine Street Suite 1250
San Francisco CA 94111

San Francisco (415) 870-8150
Newport Beach (949) 855-6400
Washington DC (202) 559-0270

and medical resources to write great quality care. Why is it important to you that Kaweah health has financial and quality medical resources to provide care? [REDACTED] why is it important to you personally?

[REDACTED] Well, like I said before, we, I'm still a Kaiser member. I will be until I turned 65, but my husband's already 65. And, for us it means a lot for me anyway, excuse me. No, especially about the cardiac care. I think that's a feather in their cap, but we, since we moved here, we've looked forward to having Kaweah health be our go-to hospital. And we just kind of bared and whatnot, going to Fresno all the time to go to Kaiser. So.

Adam: Okay. Anybody else have a strong reason why having the, Kaweah health, having the financial and medical resources to very great quality care? Why it's important to them?

[REDACTED] I think it's important that we have, they have that financial backing to keep the good doctors here. I mean, I've, I haven't had to do such major surgery with dealing with health issues like that. I try to keep as healthy as I can, but have really good doctors here and nearby is really crucial to this community.

Adam: Anybody else agree with that, that you think having financial resources means having better doctors? Raise your hand if you think that's a kind of connection, you see that connection? 1, 2, 3, 4, 5, 6, 7. Okay, great. Anybody else have a reason why financial resources and healthcare resources are important? [REDACTED] go ahead.

[REDACTED] I Think because they're the only provider for our local community, like I said, with the majority, even of urgent cares the only hospital for such a large, not just our city, but our surrounding communities as well. I think the more financially stable, the more resources that they have, the better care, hopefully that they're able to provide to the community.

Adam: Okay, go ahead, [REDACTED]

[REDACTED] Well, the financial resources at the hospital contribute to what kind of like hardware is available for surgery. How many ORs are available? How many MAs are available? I know that there are certain, there are hospitals in the surrounding area that are smaller and they have way worse reputations than Kaweah Delta, because their operating rooms just don't, they just don't have the same resources. And you have a doctor go in there and they don't have the hardware they need, or they don't have the MA that knows what's going on and that makes a huge difference in how well your operating outcome is going to be.



Probolsky Research
100 Pine Street Suite 1250
San Francisco CA 94111

San Francisco (415) 870-8150
Newport Beach (949) 855-6400
Washington DC (202) 559-0270

Adam: Okay. We're going to move on to the next topic. And that's, are you aware of any improvements that need to be made to Kaweah Delta facilities? So raise your hand if you know, of any specific improvements that facilities that need to be made. Parking, I think they need to upgrade their parking.

█ Drastically! Yeah.

Adam: Raise your hand if you know of any facility that needs to be your, okay, █ what facility part of the Kaweah Delta, Kaweah Health need to be upgraded.

█ Well, I just, when █ I mentioned parking and I fully agree, I think that's, that's half the battle. Sometimes when you're going to Kaweah Delta is just, you know, finding a parking area that's closer, convenient. Right? I know they've done a lot of construction there. I don't know exactly what that entails, but yeah, I think parking is, it's just a convenience thing. Ultimately, at the end of the day.

Adam: █ you had something else.

█ I know they're currently in the process of redoing revamping the emergency room, which I understand, but as a result currently, the rest of the hospital is crazy disorganized right there. And things are all over the place. It's just really unclear. Sometimes people going into visit where they need to be. I'm hoping that once the ER, the new part of the ER, opens up, maybe some of that will be remedied, but currently it's a hot mess. And because they're expanding in their location downtown, the parking is atrocious because that's basically where they are fronting the freeway. They, the parking lot really was where they had, where they added the Helipad, where they've expanded out and added onto the hospital over the years has then taken away parking. And unfortunately, at least at the main hospital, there's not a lot outside of that for them to add parking, unless they get a parking structure and maybe he did something with the city. I don't know how they would do that.

Adam: █ You had something to add? Facility-wise?

█ All of the ladies that have given birth there. All said that the food was like, okay, it wasn't great, like when they've given birth elsewhere, but the food was way better elsewhere. Like they were okay. But it wasn't great.

Adam: All right. So let me tell you about the mineral king wing, Kaweah Health. The mineral king wing was built over 50 years ago before there were personal computers, mobile



Probolsky Research
100 Pine Street Suite 1250
San Francisco CA 94111

San Francisco (415) 870-8150
Newport Beach (949) 855-6400
Washington DC (202) 559-0270

phones. And before we landed on the moon in 1969, and it has not been significantly updated since. The wing contains 206 of the 435 beds that Kaweah Health has at the downtown campus. There's a need for a more modern facility to better serve patients. And the mineral king wing does not comply with state earthquake standards beyond 2030, and will need to be replaced Kaweah Delta or Kaweah health is in the planning stages to build a new modern hospital wing. Do you support or oppose a new hospital wing being built? Raise your hand if in general you support a new hospital wing being built. Keep your hand up. If you do 1, 2, 3, 4, 5, 6, 7. Okay. So everybody says yes. Build the new hospital wing. All right. So, well, let's talk about modernization. So what does modernize mean to you when you think about a hospital? So you're going to modernize, what does that mean to you? [REDACTED]

[REDACTED] I think it means it's, you know, expand to accommodate more of a population. You know, if the population's growing in a town, then I think you need to expand to accommodate that.

Adam: Okay. [REDACTED] why, what, what does modernize mean to you?

[REDACTED] Combination thing. I think upgrading, some of the equipment, maybe some of the need, the dated machinery you have to do, scans that kind of stuff, updating the rooms, yeah. Modernize technology, going, paperless, building, going electronic, being able to serve customers better on a electronic basis. I know that a lot of doctors our MD live and that kind of stuff, I'm getting some of the networking stuff kind of updated and figured out as well.

Adam: [REDACTED] what does modernize mean to you when it comes to a hospital?

[REDACTED] Echoing what [REDACTED] said, it's just a matter of having equipment technology that that's up to date, not old that's hindering their operations.

Adam: Okay. [REDACTED] what does modernize mean to you?

[REDACTED] Okay. I know I agree with what the other guys are saying, but I mean, making sure your staff is trained on the newest technologies and systems and maybe making sure they're, kind of like that extension of that Cleveland clinic thing that you're cooperating with other hospitals across the country, in the world

Adam: [REDACTED] What does modernize mean to you?



Probolsky Research
100 Pine Street Suite 1250
San Francisco CA 94111

San Francisco (415) 870-8150
Newport Beach (949) 855-6400
Washington DC (202) 559-0270

[REDACTED]: I'm just like, they were just saying like more, more current equipment, more current technology. Train the staff more to work with that technology and stuff. And like you said, it hasn't really been upgraded know since it was made from making it more modern is, definitely looks like it's good

Adam: [REDACTED]. What does modernize mean to you?

[REDACTED] Obviously modernize is going to include good equipment and then new training and things like that. But if we're talking about a new wing of the hospital, then I wouldn't be expecting some modern finishes, flooring that's nice, outlets on every wall, wifi available everywhere. Like, I mean, if we're talking about a new wing of the hospital, I want it to be someplace that if I have to stay there for 10 days, I'm not going to be like dying. Cause I got a TV that's only this big, and a plug that's clear across the room so I can't get my phone and that kind of stuff.

Adam: [REDACTED] what does modernize mean to you?

[REDACTED] I think everybody's covered the majority of the technology and like the girl just before me was saying I've been in the newer wings that they've added fairly recently, but the older part, like the main hospital that's been there since I was born, also stayed there recently, just a couple of weeks ago. And it's the rooms are tiny. They don't, there's, the finishes are terrible. The technology really could be updated. I think she covered a lot of it, but hopefully like she said, the look of it and the technology and what's available there, just being more comfortable, we've been to other hospitals like in San Francisco, UCSF, UCLA, other things where they're using things that are just make it a lot more efficient, not just for the patients, but also for the staff to be able to do their jobs more effectively and efficiently as well.

Adam: [REDACTED], what does modernize mean to you?

[REDACTED] Basically I'm going to Piggyback on what everybody has said, but one of the things too is if you're going to build a wing or are they also going to include like training? Cause we have, we were, there was always a need for nurses, CNAs, LVNs. Are you going to collaborate also to provide training, with the college of sequoias nursing program. And so they can get more assistance to ease, assist the nurses and the doctors in there and incorporate all the new technology in with that and just educate also your community and why not keep our staff, you had the boomerangs that came back and keep our, you know what I mean, what I'm trying to say with regards to also more training and



Probolsky Research
100 Pine Street Suite 1250
San Francisco CA 94111

San Francisco (415) 870-8150
Newport Beach (949) 855-6400
Washington DC (202) 559-0270

teachings in collaboration with the hospital to assist with that as well, the modernization.

Adam: [REDACTED] What does modernize mean to you?

[REDACTED] Like everybody says just generally upgrading, advancing, keeping up with the times updating equipment that they're using, making sure everything's up to current standards, everything changes so quick.

Adam: Okay. All right. Very good. Yeah. [REDACTED]

[REDACTED] I was just going to add that, I would hope that it would include retrofitting the original section up to earthquake standards. Yeah. That could be horrible, horrible thing.

Adam: So, so let's, let's get to that here. The, the next thing, and that is in 2016 measure, H was a general obligation bond measure that was on the ballot and it failed to get enough support from voters. Does anybody know anything about measure H? Raise your hand, if you know anything about measure H [REDACTED] knows about measure H [REDACTED] Go ahead, [REDACTED] what do you know about measure H?

[REDACTED] I, yeah, they're just trying to pass a bond. You know, I just, honestly didn't hear a lot about it, but for the election. And so just questioning on, you know, where the money goes, you know, with this tax fair, you know, earlier we were talking about, you know, future plans. And I also think it's not important, not only highlight future plans, but highlight what you've done with people's tax money up to that point. People like to know how their money's getting spent. At least this person does.

Adam: [REDACTED] So what do you know about measure H?

[REDACTED] Lot of what he said, I know there was on Facebook, on social media. There were some groups here locally. In regards to that, I know that was a big piece. Like you said, a few years ago with the retrofitting. And I know personally when I voted, a lot of the negativity was coming because as taxpayers, we've been paying into this.

[REDACTED] Like I said, I've been here almost 50 years. We've been paying into this for a long time. We're supporting the hospital and there hasn't been transparency on where the money's going. They're building newer stuff. They're adding to the hospital. You know, we got the hello pad and the emergency room and whatnot, but some of these other things, they've had decades to figure out what they were supposed to do as far as



Probolsky Research
100 Pine Street Suite 1250
San Francisco CA 94111

San Francisco (415) 870-8150
Newport Beach (949) 855-6400
Washington DC (202) 559-0270

retrofitting for the earthquake safety and they haven't done it and they put it off and there was no transparency about why they didn't do it.

And I feel like as taxpayers, and again, my opinion and kind of from the groups that I was in reading about that it seemed like there was a lot of community concern about documenting where that was going, what they were going to do and what was going to be different because they've added onto it. But yet at the same time, there's sections of the old part of the hospital that are literally just not being used.

Adam: Okay. I want to focus on age. So I'm going to share this information here. This is the 2016 ballot measure. This is what you would have seen on the ballot. The information here at the bottom, the second section I added. So you go ahead and read about measure H that was, that failed within 16, and then we'll talk about it.

Adam: Okay. Who can tell me why they think measure H failed. Listen to that.

Just a quick thought. I don't know if it's why it failed, but it seems like a small area of the population. And it's supporting this whole bond package when it seems like the area that it serves, maybe a combination of expanding the area to include some new payers, as well as maybe, maybe a half to half, maybe with the new payers and maybe a small property tax increase. I mean, 50 bucks per 1000 dollars at cents value. I mean, that's not insignificant.

Adam: Does anybody else have a sense of why measure H might have failed.

Usually anytime you mentioned taxes and your tax is going up to me. I agree with him too. I mean, it's 50 bucks is not, there's not much going up on your taxes. And I voted for measure H. So yeah, anytime you just say taxes are going up, people are immediately turned off by that, but they don't realize, Hey, this is, this is to help your community. This is like I said, it's a hospital. You got to go to, you're going to go to it. You have to. And sometimes you have to invest.

Adam: Anybody. Remember any messages against measure H or any messages for measure H,

Like I mentioned before with the retrofitting, I don't think what I'm reading here. I don't think that the hospital part, because I remember a lot more of the, the cons as opposed to the pros for it. I don't know that the hospital did the best job, engaging the community and being detailed as far as what the statement says about what their plan



Probolsky Research
100 Pine Street Suite 1250
San Francisco CA 94111

San Francisco (415) 870-8150
Newport Beach (949) 855-6400
Washington DC (202) 559-0270

was to do with it. And I also agree with somebody who said previously, my understanding is we probably have maybe at least 40% of the patients at Kaweah Delta come from outside of those who are actual taxpayers paying into Kaweah Delta. And we're supporting such a larger community that for it, just to be all go on b [REDACTED] residents, as opposed to everybody else that is engaging, going to the hospital for services, doesn't seem fair basically. Right?

Adam: So [REDACTED] brings up a point. Anybody can go to the hospital, right? Whether you live within the boundaries of the district or not does that concerned people, you think that somehow is unfair that other people can come and use the hospital, but they don't have to pay the local taxes.

[REDACTED] Can I make a comment on that.

Adam: Please? Yeah.

[REDACTED] Okay. For me personally, I live here. We pay taxes here. We pay to support that. But because we don't feel like they provide the best services, we're paying for a hospital here, but yet we don't, even if we have the choice, if we're not like going by ambulance, and it's an emergency, we're choosing to leave Visalia and go elsewhere for care. And so you've got that happening with other people. To me, if they had more money, if they had more resources, maybe they'd be able to do better. And if they expanded the amount of taxpayers, if it was including all the surrounding cities close by that are using Kaweah Delta and added it there, then I think that it might be better.

Adam: [REDACTED] What do you think about that? That, within the boundaries, people pay taxes right now. Not really, very much at all to the hospital, but everybody can use it. Now. They still get a bill, right? They still pay the bill. Is there any concern over the fact that people, you know, across some arbitrary election line, get to use the hospital, but don't pay taxes locally?

[REDACTED] Well, I'd imagine they'd done some assessment of, let's say heal. What people from outside our community are using the hospital and then try to do some analysis. Let's say that we own 25% of our customers are coming from Tulare or from Exeter.

Adam: Why does that matter?



Probolsky Research
100 Pine Street Suite 1250
San Francisco CA 94111

San Francisco (415) 870-8150
Newport Beach (949) 855-6400
Washington DC (202) 559-0270

Adam: Anybody who comes, gets a bill, right? Whether, it's, somebody pays the bill typically. Maybe sometimes not, but why does it matter where someone lives in relation to local taxpayers users? What does that matter to you?

██████ Well, if you go back to this, they're going to ask the local community to pay the 50 bucks for a hundred 1000 and their value. Right. Then they were paying for people that aren't necessarily the priority for our community. If they're getting a bill, I guess they're getting the services and they're getting pay it back though.

Adam: Well, what do You think about it ████████, people who live outside the district use it, but you're paying the taxes, whatever those amounts are.

██████: Well, I mean, it would make more sense for them to pay, to have the arbitrary line, furthered out if those people are going to use the facilities or not. But I mean, what's the alternative, or are you just going to, check someone, where they live at before they can use the hospital and not let them use the hospital.

Adam: So, right. All right. So any future, measure H or quite frankly, any future bond would only raise some of the money necessary to fund the cost of major hospital modernization and new construction. So Kaweah Delta, Kaweah health would have to raise other funds from hospital revenues, other loans and grants. Does that make sense? Is that a good plan? This idea that, they potentially seek monies from taxpayer and they'd use revenues and loans and money from grants from federal state government put together this package between taxpayer money and other money to, in order to fund all the things they need to fund. Is that sound like a good plan, or does that sound crazy or a problem? Is there a better way? Any thoughts on that?

██████ I think it's a good plan, it's always should be a combination. It's always a community or a village, to bring everybody together to be for the good of everybody. Whether the people coming from minute with an out of the city or new city, I mean, it, doesn't, we're doing the same. Like I go have my neck fusion in Fresno, I'm doing the same thing. And believe me, they charged me up and it was paid they're going to charge him and he's going to pay it.

Adam: So ████████ it's a good plan, right? There should be something from coming from everywhere. Anybody disagree with that, that the idea of taxpayer money, coupled with revenues, loans, grants, does that jive with you? Is there anybody that doesn't think that jives, should there be some better way doing it?



Probolsky Research
100 Pine Street Suite 1250
San Francisco CA 94111

San Francisco (415) 870-8150
Newport Beach (949) 855-6400
Washington DC (202) 559-0270

█ I feel cautious about the idea of them taking out loans on top of doing bond money. Not that it's a bad idea. I mean you've got business loans. I just, I feel like where is the revenue going to come from to pay back that loan?

Adam: Anybody else have that thought or agree with that thought from █ concerned about it?

█ You don't have enough Revenue, to pay back those loans, over the course of time, then potentially your hospital's closed down. So got to over leverage yourself.

Adam: All right. So after the failure of measure H, Kaweah health committed to transparency and education, they formed a community engagement initiative. The initiative included an ambassador groups, advisory groups, public forums. There were town halls webinars. The initial goal was to involve community members in the planning of future facilities to listen to feedback and concerns from the community, and to involve others in important measures to help kind of, understand and build trust.

Adam: More than 200 community members are participating in these community engagement for groups. Do you feel like, well, first of all, has anyone been a part of any of those groups, any of that outreach? All right. And do you feel like Kaweah Delta has done a good job expanding their outreach and trust in the community through social media, town halls, public forums, all this outreach they're doing. Who thinks that they have done a better job at that kind of outreach and transparency? Raise your hand if you think they've done a better job. One, two. Okay. All right. I'm going to, I'm going to go to a bit of information here. I'm going to share it with you and you can read it and we can talk about it.

Adam: Here we go.

Adam: There we go. So go ahead and read that and we'll chat about it in a minute.

Adam: (silence).

Adam: Okay █, what stands out to you? What do you find interesting about this? █ you're on mute. Go ahead, █

█ So they are trying to find something that they can accommodate with this company. They're saying that they're highly efficient even though it's lower cost. So they're



Probolsky Research
100 Pine Street Suite 1250
San Francisco CA 94111

San Francisco (415) 870-8150
Newport Beach (949) 855-6400
Washington DC (202) 559-0270

obviously trying to save and cut corners here. Maybe they need to raise more awareness so the voters will want to pay the taxes for them.

Adam: [REDACTED] what stands out here for you?

[REDACTED] That they conduct a transparent and public bidding process. A lot of people say, "Well I wasn't able to bid, I didn't know anything about it." The fact that they're out there and letting the public know that they're trying to be transparent and they're trying to make it affordable for them to build and be able to provide more beds and so forth for the community.

Adam: Great. [REDACTED] what stands out to you?

[REDACTED] Well, it sounds like they're going to add on to the hospital instead of modernize and bring the part of the building that's already there up to today's standards. Am I misinterpreting what I'm reading?

Adam: No, you're interpreting it well. Yes.

[REDACTED] I mean, why don't you work with what you've already got and make that better rather than just add on.

Adam: Anybody else have that thought what [REDACTED] just said, improve what you have already versus build something new?

[REDACTED] Yeah.

Adam: Raise your hand if you think that's something you were thinking as well. One, two, three, four. Okay. All right. [REDACTED] what stands out to you?

[REDACTED] I can't say that from the 2016 timeframe where they were pushing [inaudible 01:02:38] till now, that I've seen any significant change as far as community engagement from the hospital. I feel like I'm pretty involved in this kind of thing. I can't say that I've noticed a difference as far as what they're really doing to increase transparency. I think the only real noticeable thing I've seen is because of that election and some of the board members that were voted in. Because of the involvement in groups I was in before, I know some of them and so I feel like I hear more from them now, but not from the hospital itself.

Adam: Okay. [REDACTED] what stands out to you in this information?



Probolsky Research
100 Pine Street Suite 1250
San Francisco CA 94111

San Francisco (415) 870-8150
Newport Beach (949) 855-6400
Washington DC (202) 559-0270

Well, I think it's pretty ambitious to [inaudible 01:03:19] this facility to be good for the next 50 years. I mean, 50 years is 50 years from now.

[crosstalk 01:03:26] time.

I mean, the technology and things like that are going to change so much. I mean, I doubt that's going to be the case.

Adam: Okay. [redacted] what stands out to you?

I think the fact that they've limited it down to two options and now we see what's next, what those options are.

Adam: Okay. [redacted] what stands out to you?

I think it's interesting that they've hired somebody who did a hospital in Merced. If they were trying to be transparent I would want to know what people think about the hospital in Merced and if they did a good job there. The other thing that stood out to me was actually the 50 years. I thought it was good that they were shooting for that high, because that means that if we're talking about hospital beds and hospital rooms, and they're looking at the projection data for how this area is going to grow, then 200 beds may not be enough beds for them to be just straight replacing. So if they were to double the number of beds by making the building taller or bigger, whatever, then that would be really awesome if that was what they were able to do for that 50 year goal.

Adam: Okay. [redacted] what stands out to you?

Just in general, I think I can commend their approach, how they're taking it. Due diligence with the bidding process, different options to consider and gaining community input for how to proceed. So I think they're doing the right thing.

Adam: Okay. [redacted] what stands out to you?

I would just second that.

Adam: Okay. Well, let's go ahead and look at some images of patient hospital rooms. The current patient rooms in the Mineral King wing are pie shaped and not conducive to positive patient experience. They're cramped, 118 square feet, lacks space for visitors and modern healthcare equipment. Patients' beds are up against a wall which limits



Probolsky Research
100 Pine Street Suite 1250
San Francisco CA 94111

San Francisco (415) 870-8150
Newport Beach (949) 855-6400
Washington DC (202) 559-0270

access to patients and limits the number of staff that can help the patients. Here, right here, this is the current ones.

Adam: The Acequia Wing patient rooms are bigger, a bit bigger and safer. They're 149 square feet and have limited space for visiting family and modern equipment. So kind of limited. The ideal patient room, the proposed new wing patient rooms would be consistent with current best practices and hospital design. Includes larger rooms of 175 square feet, have proper bathroom experience, room for medical equipment, safer overall, and allow family members to stay overnight with loved ones.

Adam: What do you all think about these different setups? Right, here's what's currently there in Mineral King. The thought is to replace it with the ideal patient room. Anybody's thoughts on patient rooms?

█ I think it's good that they're going to upgrade them to that better style, because I can only imagine the problems occurring with that bed against the wall when they're not able to access the patient all the way around to help with certain things. I just see that being an issue.

Adam: Okay. Anybody else have a thought on these setups? How the current patient rooms are?

█ You mentioned with the new patient room people can stay overnight with their loved ones, so I'm assuming that means that they can't do it already? If I'm [crosstalk 01:07:10]-

Adam: Not in the Mineral King, no.

█ Not enough room.

Adam: Yeah.

█ No, that's just terrible when they can't stay with their loved ones like that. Yeah. I've been in one of those rooms and they're not comfortable at all, not comfortable. They're not conducive to have family or anybody there.

Adam: Anybody else have a thought on the room setups? Yeah, go ahead, █ You're muted.



Probolsky Research
100 Pine Street Suite 1250
San Francisco CA 94111

San Francisco (415) 870-8150
Newport Beach (949) 855-6400
Washington DC (202) 559-0270

There's a big difference already. I've been in both the hospital rooms in the new and the old. The newer are so much better already. To be able to view what the potential newer rooms would look like are so much better. I was here, like I said, a couple of weeks ago in the old building. Even just for them to try to come in and do a lab work, for example, if they can't get you on one side, they have to call other people in to try to move the bed away from the wall to get in there.

So if you're requiring additional support, they have a hard time providing that. So already, like I said, the newer ones that they have are so much better. Then these newer ones, the amount of space in there, your ability to get around, I had been in for a stroke. If you're having to use a wheelchair or a walker to get around because of mobility issues, you're almost unable to do it at all in the current rooms, the old ones. It looks like it would be so much more accessible for individuals with disabilities to be able to get around in there with that.

Adam: Okay. Anybody else have a thought on the rooms?

Yeah, the Mineral King room looks like a prison cell.

: They're dark.

Not one I'd like to spend any time in.

Adam: you had a thought?

I think it's interesting that the size of the room is double in the new ideal patient floor plan. When you think about the size of like the carts that have to come in, if you have a new baby and they bring in like the blood testing cart, that thing is bigger than a person. Bring that in and then have a place to put it. There's not enough room in the Mineral King side. I would say in the Acequia room, it looks like that would be a really tight situation to bring the carts in for medical personnel to do their work.

Adam: Yeah. what are you thinking about this?

: There's an element of compassion, right, with the whole hospital experience. With family members being there, supporting, comfort and so forth. It's the little things I think that make a big difference. I think something as simple as the layout of a room can really enhance the comfort level of being there to support your loved ones and just the mental side of being there at a hospital.



Probolsky Research
100 Pine Street Suite 1250
San Francisco CA 94111

San Francisco (415) 870-8150
Newport Beach (949) 855-6400
Washington DC (202) 559-0270

Adam: All right. We're going to look at the two different options that are being looked at right now. Each one of those options has two phases. So there'll be a first phase and a second phase for option one and a first phase and a second phase for option two. We'll look at them both, and then we can chat about them.

Adam: So option one is two towers, right? You have phase one would be a five story tower, and here's the details, 120 beds, pharmacy, dietary, lobby. You build a 452 car parking structure. Here's the details of it. So 318 million, 318.5 million, and here's the cost. That would be one phase.

Adam: Then the second phase would come and you you'd have that finished by 2037 and then the next phase would come about a decade later or sometime later. You'd have four stories and these other details here. That's one option. Any thoughts on this concept of having one tower and then a second tower built in two different phases, phased in over time? Any thoughts on the dollar amounts?

█ I think the phase approach is a good idea, because you could also have lessons learned right from the first phase before you enter the second phase. You know what works, what doesn't work and adjust accordingly when you move into that next phase.

Adam: Okay. Anybody else thoughts on this? Oops.

█ The phases are a good idea too. Where somebody had said in the previous statement where it said, "Good for the next 50 years," this would help with technology in the halfway point going into phase two where they could maybe go better on the technology than what was previous in phase one. Or they can learn from phase one as well.

█ Yeah, or they can catch up with the technology if it's gone so far in advance.

█ Yeah.

Adam: Okay. █, you had a thought on this?

█ No, I was kind of similar. I mean, you think about it, like 10 years later they should be able to kind of get caught up as well. I mean, logistically I'm kind of wondering where these all would go.



Probolsky Research
100 Pine Street Suite 1250
San Francisco CA 94111

San Francisco (415) 870-8150
Newport Beach (949) 855-6400
Washington DC (202) 559-0270

Adam: Okay. So let's just look at that real quick. So here's this option one. You'd have the first tower then the second tower, that's the way it would look, right? Or actually technically the first tower, second tower.

Would they demolish the Mineral King wing in order to make room for these towers?

Adam: No, it would be used for something else. You can't have a hospital with that current setup based on the earthquake standards, but you could use it for other things like office and things like that. Okay, and then we've got option number two. You can see here there's one tower and the concept is you build all the nine stories, but you basically shell the top four and just keep them barren. You build out the bottom five and your second phase is actually outfitting building out the top. Gives you some flexibility in when you build that out and how you outfit it.

Adam: So here's the details. Again, the number of stories, the dollar amounts and things like that. Here's the second phase, the different costs, because it's more really just outfitting it more than it is actually functionally building it. Any thoughts on this concept? Here's the way it looks, a single tower.

With no parking structure?

Adam: No, with parking. Yeah. You've got 500 car parking structure.

Oh, okay.

Adam: Yeah, same overall concept. Just two story, two towers, versus one tower, couple of different other features. What are your thoughts on this idea that the one tower idea with the outfitting the upper shelled out floors later?

In a town I lived in five, six years ago, they had built a new hospital. They did something like this. Wasn't this size, but I don't know how they're doing now, but that seems like a good approach as well. If things move faster and they need it quicker, they could probably change the plan around, but then they have the facility already there. They don't need to worry about building the tower twice.

Adam: what do you think about this approach?

Well, I like it better than option one. I think what tha before me just said is, at least you've got the building there and then if the need be, then outfit it sooner. You don't have to wait.



Probolsky Research
100 Pine Street Suite 1250
San Francisco CA 94111

San Francisco (415) 870-8150
Newport Beach (949) 855-6400
Washington DC (202) 559-0270

Adam: All right. Anybody else have a thought on option two?

█ You'd get all that earthquake prevention that you need immediately down with one, doing this whole building at once, right? With the one tower?

Adam: I mean, you're building to current standards.

█ Right.

Adam: Okay. So go ahead and raise your hand if you like option one better. Okay, raise your hand if you like option two better. One, two, three, four, five, six. █, what's your preference?

█ I liked the first one a little bit better, because I feel like there's more room for error so that if they say, "Okay, we've got the first tower and we decided that the area is growing way faster than we thought and so now we're going to need to up it to 200 beds instead of 120 beds," then that's something they could work into the second tower. I also noticed that the car parking structure is almost half the size in the single tower versus the double tower. I don't know, I kind of liked the first one a little bit better.

Adam: Okay. All right. What about you, █ What were your thoughts?

█ Yeah, I was thinking that exact same thought, especially with the car structure. Looks like with the first one it would be almost 200 more cars than option two.

Adam: The first one has 452 car and the second one has 500.

█ But then the second tower has another car park.

Adam: Oh, I see what you're saying. I see. Okay. All right, the paying for it part. This building of a new facility, a new hospital wing would cost \$500 million or more based on what you saw there. Kaweah Health does not have all that money to pay for it. We need to raise a portion of the funds through a bond measure. As a public hospital, Kaweah Health treats all patients, regardless of their insurance ability to pay for services, your insurance or ability.

Adam: Tulare County is among the poorest counties in California and has the highest level of percentage of patients being covered by Medi-Cal, which pays the hospital the lowest rates. So as a result, Kaweah Delta is paid much less than most hospitals in the state. So now kind of with all this context, the option one, option two, how much this is going to



Probolsky Research
100 Pine Street Suite 1250
San Francisco CA 94111

San Francisco (415) 870-8150
Newport Beach (949) 855-6400
Washington DC (202) 559-0270

cost, why would you support or oppose the bond measure in general? Basically everybody said they support a new hospital wing earlier on. Raise your hand if you still support the new hospital wing based upon what you know now. One, two, three, four, five, six, seven. Okay. So everybody's still on board. What's the number one reason you'll support a new hospital, [REDACTED]

[REDACTED] Because I think they need more beds and more staffing and they need the upgrades.

Adam: Okay. By hospital I mean bond, right. So [REDACTED] why do you support a new bond measure to pay for a new hospital?

[REDACTED] Well, like I said before, I mean, I think this community is growing as if the housing being built around me is any indication, the town's not getting any smaller. So I think that it needs it to accommodate its population and it needs to stay up with the times. If it's going to be modernized and new technology and whatnot, then we need to keep up.

Adam: Okay. [REDACTED] why do you support a bond for a new hospital?

[REDACTED] Why do I support a bond?

Adam: I mean, if you support a new hospital, the way we're going to get there is by having a bond. We didn't get into the deep nuances of it yet, but why do you support that?

[REDACTED] I think it's just an important thing to have a successful business, is to modernize and keep building and improving. That's one of the reasons I liked the second option is because the hospital's currently in a fairly built environment. I mean, it doesn't have a lot of open space in its surroundings. So it seems to me, the higher you go, the longer you're going to be able to keep that hospital in the current location. [inaudible 01:20:30].

Adam: Okay. One option is to get on this ASAP. Put a bond measure on the ballot next year and get to building, assuming it would have passed. Another option is say, "Hey, hold on. Let's hold off. Maybe financial times aren't so great or whatever it is, it's in your head. Let's put this off five, six years and then do something about it." Who's in the, let's get on this now, camp, raise your hand? One, two, three, four, five, six, seven. All right. Who says, let's kick this down the road a little bit? [REDACTED] what do you say? Y [REDACTED]
[REDACTED]



Probolsky Research
100 Pine Street Suite 1250
San Francisco CA 94111

San Francisco (415) 870-8150
Newport Beach (949) 855-6400
Washington DC (202) 559-0270



Sorry. I think we need it and I think if we can get it going, the sooner the better. There would need to be changes to the proposed bond measure from how they did it last time for me to support it.

Adam:

Okay. Give me an example, what would the change need to be?



I think they need to redraw their boundary lines and I think they have the potential of raising their money by doing that. I feel like they should have done that before. Also, I think that when they proposed the last bond measure, like with the amount that would be coming out of our property taxes, they were basing it off of a 5% increase per year. That's not where we've been. We've had recessions. It's been at a 2%. If that's not going up at the rate that they're proposing that it does, then more money's coming out of our pocket for it. Like I said, the redrawing the boundaries would give them access to additional funds for community members that are outside of the voting area currently that could then feed into that.

Adam:

All right. So let's talk about the option one and I'm going to throw a lot of numbers at you purposefully, and I'm going to want to get your feedback. So option one, two towers cost approximately \$684 million to fund the hospital updates and new facilities. That would mean about 319 million for phase one and 365 million for phase two. Kaweah Health would work with banks and other institutions to borrow as much as they could to fund the project. Assuming Kaweah Health could borrow about half the money, Kaweah Health would pay for about 160 million and taxpayers would pay for 159 million of phase one.

Adam:

Then a few years later when phase two started, Kaweah Delta would pay for an additional 183 million and taxpayers would pay for the other 182 million. The total of the two bonds would be asking to be approved would be \$342 million.

Adam:

On average, an average property owner would pay a tax of \$35.55 cents a year for every \$100,000 in assessed value. Rates are going to vary over the course of the years over 30 years. So it could be as low as \$17 or so per a \$100,000 or as high as \$67 per a \$100,000. But it's going to be an average of \$35 for 30 years. So for a \$400,000 house, the homeowner would pay approximately \$142 a year for 30 years. Do you think that's reasonable? Would you be willing to support it? Raise your hand if you think that's something you'd be able to support, a \$142 or so for a \$400,000 house. One-



That's on top of what we're already paying still for another bond that isn't done.



Probolsky Research
100 Pine Street Suite 1250
San Francisco CA 94111

San Francisco (415) 870-8150
Newport Beach (949) 855-6400
Washington DC (202) 559-0270

Adam: You're right and we'll get some details on that. But yeah, so raise your hand if you're willing to support that. [REDACTED], who else? [REDACTED], is that your hand? [REDACTED] Anybody else? [REDACTED] why not?

[REDACTED] I'm not saying no, I just feel like I would need more information. I'd want to see more before I committed to one way or the other.

Adam: All right. [REDACTED] how about you?

[REDACTED] Yeah, I'm the same. I mean, I'm kind of on the fence. I might support it, I might not. It just kind of depends on the time. Is it a tax on every property? Is it a tax just on single family residences? I'd be on the fence about it. I tend to support more transportation related stuff, but I understand that the hospital's a necessary service. I'd probably support it.

Adam: [REDACTED] what about you? Why don't you support the option one or just in general those dollars? [REDACTED]

[REDACTED] Ultimately I think only a 100 and something a year is not too bad to invest in our community and the resources that we need to upgrade and give us the improvements we need at our hospital, because basically our life is in their hands, because that's the choice we have to go to. So I guess I would be okay with it.

Adam: Okay. All right. So let's look at option two, all right? The one tower, total approximate cost \$542 million to fund the updates and new facilities. Kaweah Delta would borrow as much as they could to fund the project. Assuming that Kaweah Health could borrow about half the cost, they would pay for \$220 million. Taxpayers would pay for \$220 million, phase one.

Adam: Then in a few years later phase two would start. Kaweah Health would pay for \$51 million, taxpayers for \$50 million. The total of the two bonds for taxpayers would come to approximately \$270 million. An average property owner would pay an additional tax of \$31 or \$32 per year per \$100,000 assessed. Those dollar amounts would vary based upon the year, but be as low as \$25,56 and as high as \$62,15, but overall average about \$32 a year. I'm sorry, per \$100,000. \$400,000 house, you pay approximately a \$127, \$128 per year for option number two.

Adam: Raise your hand if that seems reasonable to you, if that's something you could support. One, two, three, four, five, six, seven. Okay. So [REDACTED] you say no?



Probolsky Research
100 Pine Street Suite 1250
San Francisco CA 94111

San Francisco (415) 870-8150
Newport Beach (949) 855-6400
Washington DC (202) 559-0270

█████ No, I [inaudible 01:27:30].

Adam: Oh, you did. Okay. █████ you're in the same boat?

█████ I think we're going to have to pass a bond either way because of the issue coming up that ends in 2030. So we're going to have to pass something, but I think they're going to need to do a better job showing us what it's going to be and that their numbers are going to be accurate. I think that's where they failed last time.

Adam: So █████ brings up an interesting point. She says, "You're going to have to pass it on, because 2030's coming and you're not going to be able to use that." Is that what you're saying? You're not going to use the hospital? You think-

█████ I know that there were issues with the retrofitting for the earthquake safety issues.

Adam: Do you think the state would shut down the hospital? They'd send in the National Guard and kick everybody out?

█████ I have no idea to tell you the truth. I feel like hopefully this COVID junk's done by then. [inaudible 01:28:17] hard time shutting it down by then, but in all honesty, that's kind of how it came across that they could at least shut down the portion of the hospital that wasn't in compliance. I'm not sure that they would shut everything down, but the older part of that, from what I remember hearing back in 2016, it sounded like that was a potential issue that could come into play if it wasn't done.

Adam: Raise your hand if that fact that we talked about earlier on, this idea that 2030 is kind of looming and it's not compliant with state law for earthquake standards, raise your hand if it's a major part of your consideration for supporting a bond and a new hospital, that idea that 2030 is looming. Raise your hand if that's a major part of your consideration. One, two, three. Okay. █████ why isn't that a major part of your consideration?

█████ I mean, I assume that something's going to have to be done before then. █████ was saying, there's going to have to be something done between now and then, but I don't think it's going to get to the point in 2030 that there's going to be, like you're saying, shut it down. I don't think that's really an option.

Adam: █████ what do you think happens in 2030? You think they turn the lights off and kick everybody out if nothing's done between now and then?



Probolsky Research
100 Pine Street Suite 1250
San Francisco CA 94111

San Francisco (415) 870-8150
Newport Beach (949) 855-6400
Washington DC (202) 559-0270

It's really tough for me to say, because we've seen hospitals shut down all of a sudden quickly for other reasons, right. I just don't know that environment very well, but it's tough for me-

That environment very well, but it's tough for me to say, to be honest with you.

Adam: Raise your hand if that's something that's in the back of your head like, "I'm concerned." If you agree with the statement, "I'm concerned that Kaweah Delta could shut down at some point." Raise your hand if that's something in the back of your mind. one, two, three ...

Partially.

Adam: Partially four. Okay.

Partially.

Adam: Five. Okay, . All right. Let's look at the next slide here and you go ahead and read it and then we can chat about it. (silence).

Adam: Okay, what stands out to you here?

I didn't know they amass that much revenue. I mean, it's almost a billion dollars a year in revenue.

Adam: Okay. what stands out to you?

That the District basically only has reserves totaling the 316, and that would only cover 160 days of operating. That's kind of scary.

Adam: what stands out to you?

I'm kind of stuck on, the District has approximately 60 million in COVID-19 related losses. Can somebody explain what that means?

Adam: Okay, but you're curious about that?

Yeah.

Adam: Okay. what stands out to you?



Probolsky Research
100 Pine Street Suite 1250
San Francisco CA 94111

San Francisco (415) 870-8150
Newport Beach (949) 855-6400
Washington DC (202) 559-0270

Just how, even though they have a lot of revenues, that there's not ... This isn't, [inaudible 01:33:38]. There's a lot of potential losses here and there's ... And being in not the richest part of the state, it's kind of in a precarious financial position, it looks like to me.

Adam: Okay, what stands out to you?

I'm glad I'm not the bank having to make a decision on if I'm going to loan them money or not. I don't ... That would make me even more concerned about passing something, knowing they're relying on us for only half of it, but they're still having to get loans on the rest of that, and they're still, to me, I just feel like there should be more there to work with.

Adam: what stands out to you?

The amount of money that's coming in, but also, the 60 million in COVID-related losses. I thought the government was going to come in and assist all hospitals with that as well. I thought that they were going to be providing funding to all medical facilities who have to deal with all the COVID losses and so forth. But also, that we receive 1.2 million in property taxes. There's so much housing being built around Visalia right now, it's crazy. With Amazon coming in and UPS growing bigger, and they're building so many houses in up off of 99 and more businesses are coming in off on the industrial side, so.

Adam: The District gets a tiny fraction of any property funds from that. [crosstalk 01:35:15], obviously. Clearly not a mutual part of the revenues.

I see that.

Adam: what stands out to you?

I agree with the concern about the \$60 million in COVID-19 related losses. That makes me a little bit more hesitant to gun down, like let's get on this next year. It makes me feel like maybe we need to make back some of those losses before we start thinking about taking out a whole bunch of money to build a new wing.

Adam: what stands out to you?

The 60 million in COVID-related losses. That statement, because what constitutes that? What's the qualifier for that? It's one of the many mysteries of COVID-19.



Probolsky Research
100 Pine Street Suite 1250
San Francisco CA 94111

San Francisco (415) 870-8150
Newport Beach (949) 855-6400
Washington DC (202) 559-0270

Adam: [REDACTED] what stands out to you?

[REDACTED] Nothing really. I was just wondering, so is the total amount of property taxes 4 million? I mean, that's just a ... It was a little shocking to me that the amount of funding generated through property taxes was such a small percentage.

Adam: Okay. How about this? How about, they're looking to raise hundreds of millions of dollars to build a new hospital and they got \$300 million in the bank. Anybody offended at the idea that they want money from you? And they got hundreds of millions of dollars sitting in the bank?

[REDACTED] I don't think so. I think it's important to have off for about six months of operating budget in the bank. That's pretty typical of most businesses.

Adam: Raise your hand if you agree with [REDACTED]. That it's typical, you understand that. [REDACTED], what do you think?

[REDACTED] I kind of wish that they would have more in the bank, actually.

[REDACTED] Yeah, that does like a whole lot of money when you look at it at 176 days of operating capital.

Adam: Okay.

[REDACTED] It's not very many days, really.

[REDACTED] Six months.

Adam: Okay. Think about your neighbors, Think about if, all they heard, they're doing a bond and they got hundreds of millions of dollars in the bank. Do you think anybody might look at that and say "Back off." Right? "Go dip into your little piggy-bank and ..." I don't have half of my salary sitting in the bank, waiting for me to dip into. But they're asking, do you think anybody might look at that and say, "Hell no, use your own money." Or do you think everybody's going to agree with you guys and kind of get the picture that they need cash in the bank to operate?

[REDACTED] I think on the surface, you're probably going to get a lot of that. There's definitely going to have to be some outreach to help people understand the importance of keeping some operating revenue on the book. [inaudible 01:38:11] is their outreach, but it's going to be a problem on the surface that you're going to have to address somehow.



Probolsky Research
100 Pine Street Suite 1250
San Francisco CA 94111

San Francisco (415) 870-8150
Newport Beach (949) 855-6400
Washington DC (202) 559-0270

Adam: Okay, [REDACTED] now it's your job. You got to tell your ... you're done, and you're going to have a beer with a buddy right now in 15 minutes. What are you going to tell them about the need for a new hospital and how it's going to be paid for?

[REDACTED] Man, that's putting me on the spot here. [crosstalk 01:38:36] is really dated, we need it. If, by chance, I assume you wanted him to ask me about the 316 million they have in the bank and why they're not using that money to find the improvements, and I guess, the answer to that would be, well, that would take all of our operating capital, and should there be a lapse in any revenue or any delay, it would force us into the red and then we wouldn't even be able to provide a service at that point. These funds are important so we can continue to provide services in the event of a lapse in cash flow.

Adam: All right, [REDACTED] what are you going to tell a friend or a family member about the need for a new hospital and how we're going to pay for it?

[REDACTED] Well, I think it's going back to helping the community and the hospitals dated. We need upgrades and we want to be a thriving community for the next generation, we need to invest in the future.

Adam: Okay, [REDACTED] what are you going to tell people about the need for a new hospital and how we're going to pay for it?

[REDACTED] A lot of what they've already said, as far as what our need is in the community, the issues with the older part of the Mineral King side of the hospital and the rapid growth that we've had here, I do think it's helpful to see it the way that it's written out here, as far as them specifying. Just putting in there about how much time that is, as far as what they're operating with, with the 316 million, I think that'd also make the point that, the closest hospital to us in Tulare, which is just south of us, recently went through a closure and had the money issues and went through all of that, which impacted Kaweah Delta even further. And, they are reopened now, but because of that, I would hope that they would realize that I'm glad that they have at least that in there. I agreed with somebody else who said, "I wish they had more than the 316 million in there." But I think, if they realize that's only less than just under six months of operating costs there, that makes sense to me that they at least have back up.

Adam: [REDACTED] go ahead and unmute yourself and tell us what you would tell someone about the need for a new hospital and how it's going to be paid for.



Probolsky Research
100 Pine Street Suite 1250
San Francisco CA 94111

San Francisco (415) 870-8150
Newport Beach (949) 855-6400
Washington DC (202) 559-0270

█ I think the same as everybody else. They need to understand that the operating of the hospital needs that budget to be there as a pillow, a blanket, to catch them. If they fall, say, [inaudible 01:41:15], that's millions and millions of dollars and [inaudible 01:41:18], 50,000, 40,000 a year, like when [inaudible 01:41:22], what that money is for and what it could be used for.

Adam: All right. █ what are you going to tell people you encounter talking about a new hospital and how it might be paid for?

█ I think the things that I would highlight, if I was trying to convince my friends, is the pie-shaped room like that, right there. Hands down that immediately sold me, we need something new. And then, if we're going for a bond measure over loans, a bond, if it can pass, is much more secure than going to a loan, because the taxpayers are going to be the ones that are fitting the bill for it, instead of wondering if we're going to get it from a bank. And so, I just feel like, if I was going to tell my friends about it, I would say I would rather pass a bond to get rid of those pie-shaped rooms and to make it so that there's no chance that we're going to have to close down and drive down the road to Sierra View, which I don't want to do. That's how I would pitch it if it was going to be me.

Adam: █ what would you tell friends or family about the need for a new hospital wing and how we paid for it?

█ I would definitely encourage the bond as well, and just kind of piggyback on what everybody else said with regards to the importance of having it here within our community, importance of having the advanced medical facility available with all the latest technology and gadgets to assist all the nurses and doctors to provide the kinds of services that you said. In the very first slide, where you had all the latest things that this hospital is associated with, the Santa Clara University and all the other [inaudible 01:43:15] that it has on it.

█ I think it's really crucial and important in a such a rural community that is considered one of the poorest property of poverty, yet you have this high-stake hospital or could have this high-stakes, high with nicer rooms, nicer facilities, more upstate-of-the-art, et cetera. And, as far as bonds, well it's been known, in every city throughout our nation, that's how we get better facilities, better buildings, better things for our community. We have to kind of gather together to take care of our villages. I think it's important.

Adam: Okay. █ what ... How would you communicate, talk to people about the subject of the need for a new hospital and how it would be paid for?



Probolsky Research
100 Pine Street Suite 1250
San Francisco CA 94111

San Francisco (415) 870-8150
Newport Beach (949) 855-6400
Washington DC (202) 559-0270

██████████ I would just try and create awareness for them around the topic and encourage them to look into this. I mean, quite honestly, I didn't know a lot about this going into this conversation. And oftentimes, as a voter, we just have a lot to rely on, on the write-ups and our little ballot books, so it's not necessarily fair to the hospital or to anyone. Those write-ups are so important, and sometimes that's all that we have to go off of. As a responsible voter, I think it's important for us to understand what's at stake, and I think it's important for the Kaweah Delta to engage the community and educate. It's a two-sided deal here.

Adam: Okay. ██████████, what would you tell someone new ... Topic came up about a new hospital wing and how to pay for it, what would you tell them?

██████████ Most of my friends would probably agree that a new hospital wing is a necessity, but I think just getting information out there, and if we're going to ... If people are going to pay for a bond, well they need to really know what they're paying for and stuff like that. You gave the two options of the two different towers and people saying, "Hey which one do I like more? If I'm going to be paying a bond for this, I need to really know what I'm paying, putting my money towards."

Adam: Okay.

██████████ The information aspect.

Adam: ██████████ what would you tell someone then if the topic subject came up?

██████████ Well, I think I'd probably tell them that the last line in this paragraph, "The District does not however have the resources to build a new hospital, which is needed." I mean, Kaweah Delta, that's what we have. We don't have the money to build a new one, we've got to improve what we've got, and again, refer them to that pie-shaped room that looked like a prison cell and say, "How'd you like to spend a few days here?"

Adam: Okay, so something ... Everybody's kind of talked about, or some people have talked about education. Doing the outreach. That takes money and I'll say it, and maybe not everybody understands it, but Kaweah Delta is a government agency. They cannot, even if they put a bond measure on the ballot, they can't advocate for it. I mean, the individual people can, or the doctors can, or a board member can, but as an agency, they can't spend your tax dollars or rate moneys from the hospital revenues on advocating for the bond. They can just talk about what happens if it gets built or when it doesn't. They can talk about facts.



Probolsky Research
100 Pine Street Suite 1250
San Francisco CA 94111

San Francisco (415) 870-8150
Newport Beach (949) 855-6400
Washington DC (202) 559-0270

Adam: Everybody kind of talked about wanting to have outreach, that might cost a hundred thousand dollars, it might cost a million dollars. To send mail or send other people out into the community and talk to people via radio ad and say, "Hey, there's a bond measure, here's the things that could happen if it passes, here's the things that can happen if it didn't." Is that okay? Should they be spending money to do that kind of outreach, or should they just rely on what [REDACTED] aid, that ballot statement or ballot stuff in the ballot book? How do we ... How does that happen? Should they be spending money on that kind of outreach?

[REDACTED] [crosstalk 01:47:24] cost-effective ways to go about it. I didn't see them utilizing social media at all before. Everything on social media I saw last time, was against the measure.

Adam: Sure, so it's okay with you, [REDACTED] if Delta puts out messages saying, "Hey, there's a need for a new hospital, and if we don't have it, here's the concerns we have. If we do get it, here's the positive things that could happen." That's an appropriate use of their resources?

[REDACTED] To me, if it's informational, I can ... I get your point in saying that they shouldn't advocate, like tell you, this is what, do it. But, if they're putting out information like what we've seen here, these are the plans. These are the numbers. This is what we need. This is why we need it. If they're putting out information, I think that's going to get them in one, social media isn't going to cost them much, doing livestreams on things, the way that you're doing here, that they do. [crosstalk 01:48:14]

Adam: I agree, but, somebody goes in everybody's mailbox is the kind of thing that gets to everybody because not everybody's on Facebook.

[REDACTED] Most people throw it away anyways. If I get stuff in the mail, that's just random stuff like that, most people that I know were throwing it away.

Adam: Right, so maybe--

[REDACTED] [inaudible 01:48:28] have to wait.

Adam: They might have to buy TV commercials, cable TV, or they might have to do other kinds of things, make graphics for social media, is it okay? Raise your hand if you're okay with the District spending money on outreach activities.

[REDACTED] It's ... I think it is.



Probolsky Research
100 Pine Street Suite 1250
San Francisco CA 94111

San Francisco (415) 870-8150
Newport Beach (949) 855-6400
Washington DC (202) 559-0270

Adam: [REDACTED] how do you think they should do it if they can't spend money on it? Or maybe they don't have to, maybe it's not their job.

[REDACTED] Yeah, like you just said it, maybe they don't have to. I know it's pretty much all elections with all the different propositions and measures that get passed. Most of the people don't really do the research on what it is. They just go off the ballot statement, really, so just having an effective ballot statement for whatever measure, is really their last line of defense.

Adam: All right. We've got a few more things we want to talk about, so we talked about a little bit, but, this idea that people who live outside the District, can use the facility. Now, I'll juxtapose that with, if you're in New York and needed to go to the hospital, you go to a hospital in New York, you don't care, who's paying the taxes, and if someone is visiting Visalia and from Houston, they're going to go to the hospital. But, there was some talk earlier about this idea that, "Wait a second, I'm paying the taxes here. I'm going to repay this bond, but those people get to use this hospital." Who's still concerned about that dynamic that people outside the boundaries are getting to use this hospital? Raise your hand if you're still concerned about that situation. One ... Just one? You're paying the taxes.

[REDACTED] A little bit. I think, after seeing the percentage of operating revenue that comes from the actual [inaudible 01:50:18], kind of swayed out a little bit.

Adam: Okay. I mean, that's a good point, so let's ... Yeah, go ahead, [REDACTED]

[REDACTED] Well I think, to [REDACTED] point, she's concerned about the District boundaries, that's her main concern. And, I kind of feel like, if you look at Farmerville and the mean income in Farmerville, it's not sky high. It's not like we're excluding some millionaire that's outside of our boundaries. We're going to be serving people that come in from outside, just like Fresno's serving people that are driving up there, so I don't know that redrawing is going to be the answer.

Adam: Okay, so much of the advanced care available at Kaweah Delta, Kaweah Health, open-heart surgery, neurosurgery, cancer-care would not be available at Kaweah Health if the hospital didn't serve patients from outside the Healthcare District. When people from outside the District seek care at Kaweah Health, the bills they pay, help support additional services at the hospital. Does that kind of reconcile? Does that message kind of jive in your head? That, the fact that people from outside of the boundaries, pay for



Probolsky Research
100 Pine Street Suite 1250
San Francisco CA 94111

San Francisco (415) 870-8150
Newport Beach (949) 855-6400
Washington DC (202) 559-0270

some of the bills and allows the ... All the services in the hospital to be elevated. That make sense to everybody?

[crosstalk 01:51:38] Yeah, but why is anybody paying taxes then? With that argument, why is ... How is their boundary established?

Adam: Okay, somebody else have that same thought?

Mm-hmm (affirmative).

Adam: Okay. All right, so Kaweah Delta has met with the surrounding Healthcare Districts, that do not have hospitals, to discuss merging Healthcare Districts or evaluating options that would allow other Districts to help support Kaweah Health's building of a replacement facility. How do you feel about that? This idea that you'd expand the boundaries to have more people paying, let's say, bond repayment. But also, they were ... Those people would be within the boundaries of the District. Anybody think that's a good idea? Bad idea? Raise your hand if you think that's a good idea.

It's good, yeah.

Adam: Anybody think it's a bad idea? Expanding the boundaries of the District? What's the downside,

Well, I think the downside would be, if we are expanding our umbrella. I mean, I think it probably is a better idea, but if we spin our umbrella, that means that, that's that many more people coming and filling up beds that should expect to be able to use their taxpayer dollars in this hospital instead of going to the hospital that may be closer to them because they're in the same District as that hospital.

Adam: Interesting. Okay. What didn't we talk about tonight? What didn't we ... Oh go ahead.

Yeah, but if I can just speak from experience, I know people that have gone to Stanford that have hospitals in the Bay Area, people would go to hospitals in Southern California.

San-Francisco.

Exactly. I think the other aspect is, when that happens, the economy gets a little boost too. When you have visitors from out of town, helping hotels or local businesses,



Probolsky Research
100 Pine Street Suite 1250
San Francisco CA 94111

San Francisco (415) 870-8150
Newport Beach (949) 855-6400
Washington DC (202) 559-0270

restaurants, and so forth. I think that's another consideration. I'm fine with it. I don't have any issues with it. I just wanted to bring that perspective a little bit outside, but.

Adam: Cool. No, that's great. What didn't we get to tonight? What should we have talked about, that we didn't talk about? Yeah, [REDACTED]

[REDACTED] Really, if we're talking about why 2016 failed, I think maybe we need to talk about what were the negative messages that caused it to fail, because obviously it had enough good stuff going for it that all of us here feel like this is probably something we should do, but it failed because the negative messages of whatever campaign was happening in 2016. Whatever it was that caused everybody to pause and not vote for it, is really the problem here.

Adam: Okay. Anybody else? What didn't we get to tonight? [REDACTED] what didn't we talk about that we should have talked about?

[REDACTED] I think more about the outreach. I think that, I mean, in like 2016, I had just moved here, so I don't remember that [inaudible 01:54:45], but how do you get this information out and dispersed out? Because, I'm ... If I saw that now, I'd vote for it without even thinking twice.

Adam: All right. Anybody else? What didn't we get to?

[REDACTED] I don't know anybody personally here, even with all the people that were against the previous measure, I don't know a single person who would not agree, if they've been to Kaweah once, I don't know anybody that wouldn't agree that we need better. We need more from Kaweah Delta, that we need more space. Nobody disagrees with that part, but I do ... What they said before, they think the messaging failed big time last time.

[REDACTED] That, in all honesty, I think social media has swayed that boat against that previous measure, and I did not see ... I've seen more information on this call tonight than I did during the whole process of what they did [crosstalk 01:55:39] with that previous measure before, and if they're better at putting that information out and explaining it and being transparent about it and getting that feedback and community buy-in, because we're taxpayers who are going to pay for it, they'll need buy-in from us. And, that's where they need to really make improvements. I think, also, they need to work on the level of service because I noticed, in a lot of their statements on here, it talked about world renowned care, but when you look at their numbers, their data, as far as patient satisfaction, is under 50%. And, to me, when that's happening, patients don't



Probolsky Research
100 Pine Street Suite 1250
San Francisco CA 94111

San Francisco (415) 870-8150
Newport Beach (949) 855-6400
Washington DC (202) 559-0270

trust, they don't feel comfortable there and they are leaving the area because of that. They're going to need to work on that too, to get us voters to buy into that again.

Adam:

[REDACTED]



Probolsky Research
100 Pine Street Suite 1250
San Francisco CA 94111

San Francisco (415) 870-8150
Newport Beach (949) 855-6400
Washington DC (202) 559-0270

Group 5

Adam: Good evening. Welcome to our discussion group about healthcare in Tulare County. That's the big reveal on the subject we're talking about. My name is Adam Probolsky. I run a research company here in California. I live in Orange County. That's Orange County airport behind me. And helping me tonight are [Shalom 00:00:19] and Scarlet. If there's any tech issues or anything, they may reach out to you. And I'm going to start to record because we didn't do that.

Speaker 1: Recording in progress.

Adam: Okay. So we're on a first name only basis tonight. Just makes it simpler. So if everybody can just signify they're okay with being recorded because I can't take notes that quick, just thumbs up or say yes or anything like that. All right. So we are ... oh, by the way, you were selected because you live in Tulare County and actually a specific part of it because we'll get into the details of that.

But it's not like you're ... there's no other qualifications for being in this group. Sorry. And our goal is to have a frank and open discussion tonight. Just as great to have negative comments as positive comments. It's really important that only one person speaks at a time and that you direct all comments back towards me, especially in this format because it's really easy to get off-track with multiple people talking. Feel free to share whatever's on your mind. Definitely don't want anybody to dominate the conversation, but I want to hear your full thoughts. If you agree or disagree, say why. And definitely not my role to have an opinion, but I may bring up ideas to see what you think about them. And so with that, let's introduce yourself with your name, the first name, the way you'd like it to be said. And then go ahead and tell me one thing about yourself in six seconds or less. So I'm Adam and I haven't been on a plane in 18 months. [REDACTED] why don't we go with you next?

[REDACTED] I am [REDACTED] and I'm a stay at home ... was mom, empty-nester now with lots of grandkids to watch over due to COVID.

Adam: Beautiful. I mean, not beautiful COVID, but beautiful your family. [REDACTED] why don't we go to you next?

[REDACTED] [REDACTED]



Probolsky Research
100 Pine Street Suite 1250
San Francisco CA 94111

San Francisco (415) 870-8150
Newport Beach (949) 855-6400
Washington DC (202) 559-0270

[REDACTED]

[REDACTED] Yeah. You said it right. You guys can call me [REDACTED]. I go by [REDACTED] too. I love traveling. Like you, Adam, I haven't been on a plane in a long time, but I miss that. A [REDACTED]

Adam: Soon. [REDACTED]

[REDACTED] I'm [REDACTED] I am employed in the agricultural industry and COVID really hasn't affected us. We've been working every day still. And everybody seems to be pretty happy and healthy. So pretty much that's the story there.

Adam: Great. [REDACTED]

[REDACTED] [REDACTED]

Adam: Very nice. [REDACTED]

[REDACTED] Hi. I'm [REDACTED] And I haven't been in the office in 14 months.

Adam: Very nice. I'm back for about a month. It's very nice.

[REDACTED] Not nice.

Adam: Well, yeah. No, no. I'm lucky enough to have been back. [REDACTED] how about you?

[REDACTED] My name is [REDACTED]

Adam: All right. Welcome. [REDACTED]

[REDACTED] Yeah. Hi, I'm [REDACTED]

Adam: Okay. And [REDACTED]



Probolsky Research
100 Pine Street Suite 1250
San Francisco CA 94111

San Francisco (415) 870-8150
Newport Beach (949) 855-6400
Washington DC (202) 559-0270

Hi. My name is [REDACTED]

Adam: Fantastic. All right. And am I saying it right? [REDACTED]

Yes. You pronounced it correctly. So my name is [REDACTED]

Adam: Exciting. Okay. Well, welcome everybody. Thanks for being with us. Let's get right into it. What do you know about Kaweah Delta or Kaweah Health? Why don't we start with you, [REDACTED]

I know that they've done a pretty good job. I [REDACTED] Especially now with COVID, everything kind of changed, but I give them lots of credit for the way they ran their business over there with the hospital. And then I've had a couple of times where I've taken my six year old and nine year old to the hospital. And I think they've done pretty good. [REDACTED] When we moved out here and we started going to doctors over here, I haven't really had any kind of bad interaction with them.

Adam: Good. [REDACTED] how about you? What do you know about Kaweah Delta, Kaweah Health?

Well, unfortunately I know quite a bit. I've been a patient there many times. In fact, the last time, I had a kidney function [REDACTED] and was told that I would more than likely be expiring that night. So I was lucky enough to make it out. [REDACTED]

Adam: Well, we're glad to have you with us.

Kaweah Delta is, for me, an awesome organization.

Adam: That's awesome. [REDACTED] what do you know about Kaweah Delta, now known as Kaweah Health?

I have made comments about it. There are times where the staff is really on top of it. There are times where the staff is really lacking. [REDACTED]



Probolsky Research
100 Pine Street Suite 1250
San Francisco CA 94111

San Francisco (415) 870-8150
Newport Beach (949) 855-6400
Washington DC (202) 559-0270

Medically speaking, he should not have had to wait in the emergency room with exposed bone for over seven hours. So there's things they need work on, there's things that are okay. But there's just a lot of negative compared positive for my family. Some people have good experiences. We unfortunately have a lot of bad experiences.

Adam: All right. what do you know about Kaweah Delta, Kaweah Health?

Like I've had personal experiences there, in particular with the cardio unit. Having to have gone in as an emergency patient with cardiac failure, I have nothing but 1,000% confidence in their ability. Of course, they're also connected with Cleveland Clinic. And while I was there at the cardiac unit, I got the feeling and the impression that I was at a university hospital. They were very, very much right on the patient care.

. So I've got nothing but great things to say about them. And I also use their doctors as far as the clinics are concerned for my general GP and other areas as well. So I very much, like I hear a lot of bad things about Kaweah Delta. But my experiences has been just 100%.

Adam: All right. what do you know about Kaweah Delta, Kaweah Health?

I've experienced a lot there. Gave birth to three of my children there. I know employees and I know patients. And the more I know ... right now, the first word that comes to mind is monopoly. You don't have another option in Visalia. In Tulare County, maybe you do. But they're pretty much taking over and they are what they are. And if you want somebody else, you better go out of county. I've had good and bad. The MRSA situation didn't surprise me. I had a friend in there. And upon the visit, the cleanliness of her room was greatly in question.

Yeah.

But I also had a wonderful experience in the cardiac unit where it couldn't have been better. And it was very, very professional, very well cared for. So good and bad.

Adam: how about you?

Until last year, I was on one of the community advisory committees for Kaweah Delta for two years. My own



Probolsky Research
100 Pine Street Suite 1250
San Francisco CA 94111

San Francisco (415) 870-8150
Newport Beach (949) 855-6400
Washington DC (202) 559-0270

personal experience, I only had one experience in the emergency room and they were fabulous. They were completely overloaded. And I had to be treated in the hallway because they just simply didn't have capacity. But they did a great job. And I was in and out in no time. Friends and coworkers that have had experiences there, I've never heard a single negative comment from any of them. And that's everything from cancer treatment to kidney, to cardiac, a couple of helicopter rides, those types of things. So that's what I know.

Adam: [REDACTED] how about you? What do you know about Kaweah Delta, Kaweah health?

[REDACTED] I've been in Visalia for [inaudible 00:12:37] years and I've always at least as I've been here, I've always understood it to be probably one of the most important institutions in our community there is. I've had to use the services there, not a lot. And every time it's been, as you would expect from a hospital, people trying to help you. And that's been my experience. And my daughter was [inaudible 00:13:17] there. And it's been good, in my opinion.

Adam: Okay. [REDACTED] what do you know about Kaweah Delta, now called Kaweah Health?

[REDACTED] Well, I haven't been in the hospital myself. The only bad experience that I had was with my wife. I took her for ... she had high blood pressure. And we have to spend the night in the hospital. And the only thing I that we never got admitted to any rooms. And the following month I got a bill for [REDACTED] just for being seen outside. It's good to hear that people had good experiences because I haven't been in the hospital yet. But you know, it's nice to know that they do have those services.

Adam: Okay. [REDACTED]

[REDACTED] Got it. It's difficult when you say your experience with [inaudible 00:14:25] because super broad. Yeah, so I have a good friend that's on the board. I have a couple of friends that are doctors. I have some friends that are nurses. Had a couple bad experiences there myself. But you know, is that the institution or is that the doctors that practice there? Those could be separate issues. When I was diagnosed with [REDACTED] my local doctor decided that I should not have the surgery that I needed there and sent me to [REDACTED]

Adam: Okay. All right. [REDACTED] what do you know about Kaweah Delta and Kaweah Health?



Probolsky Research
100 Pine Street Suite 1250
San Francisco CA 94111

San Francisco (415) 870-8150
Newport Beach (949) 855-6400
Washington DC (202) 559-0270

█ I know Kaweah Delta is a level three trauma center. One thing that surprises me is that Kaweah Delta serves the entire Tulare County and that's a lot for such a small hospital. Definitely need a trauma level two or one. That's what we're severely lacking for the county. Another thing is that Kaweah doesn't really offer much clinical trials. █
█. And that's something that I think Kaweah Delta and Tulare County would benefit from. Just because with industry sponsor trials, it gives the community an opportunity to get medical care paid for 100%. Usually if they do a clinical trial, that's something the hospital will benefit from as well as the community. So I think that's something that created Kaweah Delta lacks. I don't know much about Kaweah. Of course I've been there many times because I grew up there. The last time I was there, I took a family member to the ER. And I had a great experience. But it is kind of small. I know they're going through a renovation right now, well, the last time I went. And then there wasn't really a waiting room. Hopefully that would open up soon. So I would like to see maybe an expansion or a satellite site because definitely Tulare County has outgrown the hospital.

Adam: Okay. We're going to take a look at a slide, and I'll have you guys read it, and then we'll talk about it. So there we go. Take a look and let's chat in a second. Yeah. Okay. █ anything surprising, super interesting that you read just there?

█ Not really. I mean, basically this paragraph is filled with information that I was already aware of. █
█ And so I'm very well acquainted with medicine and the medical industry. So there's nothing here that surprises me.

Adam: All right. █ anything surprising here or super interesting to you?

█ I would say just the number of employees. I didn't realize there was that many employees there. 5,100, it's a pretty good amount of employees.

Adam: Sure. █ how about you? Anything stand out to you?

█ It just provided an awful lot of information. I didn't realize how large and how extensive the hospital was. And so this does provide a lot of insight as far as the number of employees, also the services that are offered, and the fact that it has over 600 beds. I wasn't aware of that. And also the medical staff as being 600, that surprised me.

Adam: All right. █ how about you?



Probolsky Research
100 Pine Street Suite 1250
San Francisco CA 94111

San Francisco (415) 870-8150
Newport Beach (949) 855-6400
Washington DC (202) 559-0270

█ The percentage. Just the percentage of beds to the population of Tulare County. And that's one bed for every thousand people in Tulare County. Now you're not going to need that. But I don't know what the percentage of people that are experiencing emergencies or medical conditions that need beds. And that seems like it could definitely be increased.

Adam: Okay. █ anything interesting that stands out to you?

█ I'm pretty familiar with all of that already.

Adam: All right. █ how about you?

█ Nothing surprising in particular. It's just the statistics. I figured it employed about that many people.

Adam: Okay. █ anything interesting there to you? You're muted █

█ Can you hear me now?

Adam: Now we can. Yeah.

█ Somebody talked about how many beds they have on the site. I think that's something really amazing because now with COVID, before it was packed, probably they need to extend those a little bit more.

Adam: Okay. █ anything surprising here to you?

█ Not really. It's pretty straightforward.

Adam: All right. █ how about you?

█ I'm quite confused by the fact that they say neurosurgery. Like when someone goes into the ER and they're complaining of back pain or anything, they don't even bring in any kind of doctor. These are all residents that are learning or a nurse practitioner that are learning the trade or the, whatever you want to say, that area, specialty. I can't even imagine that they even have enough doctors to take care of 613 beds, let alone the emergency room. So it seems like this paragraph is a little misleading to me. That's just how I feel about it, misleading.

█ I have a question.



Probolsky Research
100 Pine Street Suite 1250
San Francisco CA 94111

San Francisco (415) 870-8150
Newport Beach (949) 855-6400
Washington DC (202) 559-0270

Adam: [REDACTED] go ahead.

[REDACTED] Out of the 5,100 employees, it would be interesting to see that figure broken down into trained staff versus housekeeping versus whatever.

Adam: All right.

Janet: Yeah. I agree.

Adam: [REDACTED] what stands out to you?

[REDACTED] I think these are something that's commonly published. I think one thing is probably neurosurgery and cancer treatment because a lot of people I know who need surgery or the cancer treatment usually gets referred out of Visalia. And then usually it's kind of inconvenient for them to get cancer treatment because sometimes it's every other week or it's kind of frequent. And they had to be referred out because they were told that they don't offer that here in Visalia. So I don't know whether the cancer treatment center is small here or they just was out of scope, but I just was surprised that was listed.

Adam: Okay. So [REDACTED] How many of you knew that Kaweah Delta was a healthcare district, was a public agency that you basically control as voters? Raise your hand, keep them up. [REDACTED]

[REDACTED] I didn't know.

Adam: You did or you didn't, [REDACTED]

[REDACTED] I didn't know.

[REDACTED]

[REDACTED]

Adam: Didn't. Okay. All right. Okay. Very good. We're going to take a look at a map here. This map is of the boundaries of the healthcare district. So the people that live inside this boundary are the ones that vote for the [inaudible 00:24:06] board members. The people that live inside this boundary also would pay any taxes specifically to the health care district. If there are any taxes ever levied, they would be just to the people within



Probolsky Research
100 Pine Street Suite 1250
San Francisco CA 94111

San Francisco (415) 870-8150
Newport Beach (949) 855-6400
Washington DC (202) 559-0270

that boundary. Right now, there's a very small bond, a very small amount that property owners might pay. But right now it's very limited. Anything surprising about this map to people or interesting?

■ Isn't Farmersville in Tulare County?

Adam: Yeah. So this is the boundaries of the district, not the county. So the district doesn't contain the entire county. It's just a portion of it.

■ So this is the people that live within this boundary, their taxes are supporting the hospital. But people that live in Farmersville or [crosstalk 00:25:11] or Tulare, maybe not?

Adam: Let's be clear. There is no tax that is being paid by residents in the boundary. There's no particular tax that's being paid. But if, let's say there were to be a tax or there were to be ... there's a bond, there's a very small bond from years ago that property owners are still paying. So really it's a matter of this is the voting district is what this is. So if you live outside the boundary, you don't vote for the board members. But you can certainly of course go to the hospital. So yeah. Anything else surprising to people?

■ And Adam, it's my understanding that if you live in the district, then any bond or any tax that would be levied would be voted on by the residents of the district, is that correct?

Adam: That's correct. Exactly. Yep.

■ Adam, would the tax be applied obviously to people outside the district into the neighboring towns?

Adam: So no. Let's say there was to be a tax placed by the healthcare district, then no. People only within the boundaries would pay that tax or-

■ I hold objection to that obviously because it's a very, very small district, but yet it serves a much greater community. So I would like to see it included and expanded to a much greater degree.

Adam: Okay. Interesting. All right. So let's talk a bit about the Kaweah Delta, or now known as Kaweah Health. And by the way, raise your hand if you had heard that they changed their name to Kaweah Health. Keep your hands up. One, two, three, four, five, six, seven. Okay. So in general, do you trust Kaweah Delta? Do you trust Korea Health to provide care, leadership to tell you the truth, to always consider the community's best



Probolsky Research
100 Pine Street Suite 1250
San Francisco CA 94111

San Francisco (415) 870-8150
Newport Beach (949) 855-6400
Washington DC (202) 559-0270

interest at heart? In general, do you trust Kaweah Health? Raise your hand if you do. One, two, three, four, five, six. Okay. [REDACTED] why don't you trust health?

[REDACTED] I don't know. I think it's just personal experience from the past. It depends. I mean, if I'm going there for a minor injury, yes, I'll trust them. But if I need some specialty care, like I would say neurosurgery or cancer treatment, I'll definitely seek one of the bigger universities like UCSF or UCLA, because they just have more professional ...

[REDACTED] Because they just have more professional specialties in that field.

Adam: [REDACTED] why don't you trust Kaweah Health, in general, to provide care, to tell you the truth to serve the community's interests? Why don't you trust them?

[REDACTED] Was that me?

Adam: Yeah. Why don't you trust them?

[REDACTED] Well, like I said before, I had a bad experience when I took my wife. Myself, I've never been in the hospital, so I can't really say anything for my own, but that's the only reason.

Adam: Okay.

[REDACTED] Adam, I feel like you're talking about... Trust is really broad. Do I trust them to be transparent-

Adam: That's what I'm looking for. I'm looking for that big, broad, general, "do you trust them" concept idea.

[REDACTED] Yeah. And I could say administratively, sure. I trust them. I trust them to be transparent. Would I trust them with my medical care? No.

Adam: Okay. All right. And then raise your hand if you trust the leadership to tell you the truth, to always be honest with you and tell you the truth of what's happening in the world or what's happening at the hospital, things like that. Raise your hand if you think you trust them to tell you the truth. One, two, three, four. All right. Okay.

Who do you trust most to talk to you about the future of the hospital? Do you trust the CEO? Do you trust a board member? Do you trust a doctor, a nurse, the media? In general, who's the one person you would trust to hear about the future of the hospital? About the future of what's happening at Kaweah Health? [REDACTED] when you think of the



Probolsky Research
100 Pine Street Suite 1250
San Francisco CA 94111

San Francisco (415) 870-8150
Newport Beach (949) 855-6400
Washington DC (202) 559-0270

person you trust the most about the future, who would that be to tell you about the future of the hospital?

Well, much like [REDACTED] I know some of the current board members, I've had relatives who have served on the board in the past and I know them to be honest, decent, good people. So I think if I were to have a conversation with one of the board members, especially one that I was familiar with... I think you have to use your brain and I think there are some things I would go to Kaweah Delta for and there are some things-

Adam: [crosstalk 00:30:51] about who you trust-

I understand, but I'm saying is, if I was going to listen to anyone, it would more than likely someone I was familiar with on the board.

Adam: All right. So a board member. [REDACTED] who would you trust to tell you about the future of the hospital? They can work there, they could work outside of it, but who would you trust to tell you about the future of the hospital?

Well, I'd say employees, I've had a couple of run-ins with some of the employees at my previous job and whatever questions I've had for them, they've answered them. I try and follow them on social media too. I mean, if you're not going to the hospital, but you still get updates with some of the social media platforms, the news media too, whatever they say too about it. But I would say that the employees that I spoke with that I still keep in contact with would be my main source.

Adam: Okay. [REDACTED] who do you trust about telling you about the future of the hospital? It could be board members, CEO, doctor, reporter. Who would you trust to tell you about the future?

Well, being that I don't personally know anyone in any of those capacities, I would think it would be a board member, I would think. Or the board of directors or possibly the administrator. That's where I think I would seek my information from. Oftentimes, when you're talking to employees, oftentimes employees don't really have a full understanding or the full scope of knowledge of the true direction the hospital is headed, so I think I would want to reach up a little higher than that and that's pretty much where I would go to. It's unfortunate I don't have any personal relationship with any of the directors or anyone on the administrative staff, but that's the direction I would go.



Probolsky Research
100 Pine Street Suite 1250
San Francisco CA 94111

San Francisco (415) 870-8150
Newport Beach (949) 855-6400
Washington DC (202) 559-0270

Adam: [REDACTED] who would you trust to tell you about the future of the hospital?

[REDACTED] It's too general a question.

Adam: You got to pick one person they got to be wearing a-

[REDACTED] I would not.

Adam: [REDACTED] who would you trust to tell you about the future of the hospital?

[REDACTED] A board member.

Adam: All right. [REDACTED] who do you trust to tell you about the future of the hospital?

[REDACTED] I would trust the board. [inaudible 00:33:14] board member. I know I looked at some minutes in the past that might've been associated with the hospital and some of their business in the board. That was a long time ago. But yeah, that's where I would go.

Adam: Okay. [REDACTED], who would you trust to tell you about the future of the hospital?

[REDACTED] I would say the board members.

Adam: Okay. [REDACTED] how about you?

[REDACTED] Board, CEO. The people whose job it is.

Adam: [REDACTED]

[REDACTED] I would say an employee that's a board member, so they're kind of working in the hospital and know what's going on and what's needed and they also serve the board so they can voice their opinion.

Adam: Board members are elected officials and employees are employees. Who would you trust?

[REDACTED] See, because the employee can only see a certain level and then the board members see overall, so I would say a board member.

Adam: All right. And [REDACTED] how about you? Who do you trust to tell you about the future of the hospital?



Probolsky Research
100 Pine Street Suite 1250
San Francisco CA 94111

San Francisco (415) 870-8150
Newport Beach (949) 855-6400
Washington DC (202) 559-0270

█ I would say the board members because we elected them in and we can take them out. If they're not going to be honest and give us the truth, then, see you later, you're not worthy of our vote and you're not worthy of the position.

Adam: █ brings up a good point. You elect the board members on one hand. But it's 2021, we kind of like beating up on elected officials. They're just politicians to a lot of people. They raise money, they spend money to get elected. Is anybody concerned about that? A lot of people said board members. I'm not anti-board member, but I want to just get a sense, just making sure everybody knows they're elected officials. Does anybody have any concern over that? Raise your hand if you still think that the board is a trusted source for you. You're going with Janet's idea that you put them into office, so they're kind of accountable to you.

█ I'm not really going with that idea. I think that on a national level, yes, I probably don't trust any politician, frankly. But these are local people. These are people that I live next to, these are people I know. It's a different ball game, Adam.

Adam: Okay. █ you're smiling. What's your thought on what I was just saying?

█ I was just thinking of [inaudible 00:35:52] Hospital. I don't want to go there.

Adam: Okay. All right.

█ I see the hospital board as a political entity that you become a part of if you have real political aspirations. It is more service minded folks that tend to take those roles.

Adam: Do you think your neighbors would agree? These are people that are committed to the community?

█ Right?

Adam: Okay.

█ These are people that we go to church with or we go to the Lion Club with, that we meet in the grocery store or walking along the pathway in the park. So these are ordinary everyday people.

Adam: That's great. All right. Put yourself into one of the two different camps here. I'm going to give you two statements and you guys get to choose. Do you think Kaweah Health is just a small town hospital you go to because it's close or is Kaweah Health the hospital you



Probolsky Research
100 Pine Street Suite 1250
San Francisco CA 94111

San Francisco (415) 870-8150
Newport Beach (949) 855-6400
Washington DC (202) 559-0270

choose for complex care because you want to go there. Raise your hand if it's just a small town hospital, if you think that's the way you look at it. One, two, three, four, five, six, seven, eight, nine. Oh boy. All right. Anybody want to change the idea, that it's a place you choose to go to for complex care? Okay.

Like I said, Adam, I am totally pleased, satisfied over 100% with the cardiac treatment at the cardiac center. I wouldn't be here if they weren't adept at what they were doing, so I'm definitely sold on that. But as far as orthopedics, I go to Fresno for orthopedics. I don't go local for orthopedics. So it depends upon the type of service I'm looking for and whether or not I feel confident in the services that are being offered to correct or address a medical problem that I might have.

Adam: All right.

I think, Adam, it's a matter of people have medical needs that have to be met now. You don't have time to go to Stanford or San Francisco or somewhere where you can get a higher level of medical care. And there are some very fine physicians, as just said, at Kaweah Delta. But if I was going to choose, I may go to a hospital that has just a bit of a higher pedigree, I think is the best way-

Adam: let me have you pull your camera down just a little bit so we can get the full perfection of your face.

Whatever.

Adam: All right. As mentioned earlier, someone mentioned, I think it was who mentioned it, Kaweah Delta is affiliated with the Cleveland Clinic for cardiac care. Before this call, raise your hand if you knew that Cleveland Clinic and cornea health were affiliated with each other. One, two... you were familiar, right?

Yes.

Adam: Okay. One, two, three, four, five, six. Okay. Does that make a difference to you? Is that meaningful to you? Does that mean something to you?

I believe it does.

No.

Adam: Who said no?



Probolsky Research
100 Pine Street Suite 1250
San Francisco CA 94111

San Francisco (415) 870-8150
Newport Beach (949) 855-6400
Washington DC (202) 559-0270

██████

Me.

Adam:

Okay. That doesn't matter? All right. Anybody else feel like that's a pretty strong thing or doesn't really matter or any other thoughts on that?

██████

It could matter to me if I knew more about Cleveland Clinic's credentials, what do they bring to the table as a partner?

Adam:

Okay. Very good. All right. I want to get a sense of why you think it's important that Kaweah Health has the financial and medical resources to provide great quality care. The statement is, "Kaweah Delta having financial and medical resources to provide great quality care is important part to me because..." Why don't we start with you, ██████ Why is it important for you that they have the financial and medical resources to provide great care?

██████

I mean, nobody close to me has ever had any major care at Kaweah Delta, but it's also good to know that they do have the proper equipment, proper staff, at all times to get that help in case something would ever happen. I would say it is important to me to know at least that it's there. I don't have to go all the way to Fresno if I have to or down to LA. I think it's always good to know that our hospital nearby is up to par with most of the hospitals around the area in case, God forbid, I have to go for surgery or for something big like that. I think it's good to know, for all the people that live in the community that use the hospital for those purposes, to know that the hospital is up to par and it's [inaudible 00:41:03] to be out on that level compared to other hospitals around the area.

Adam:

All right. ██████ why is it important to you that Kaweah Delta has financial and medical resources to provide great quality care?

██████

Medical technology is advancing rapidly and with that advancement, the machinery, the support mechanisms that doctors and the hospital needs and can use, and as you grow forward, that expense just continues to grow as well. Especially when I found out that they had a da Vinci machine at the hospital, that impressed me.

I think, as a general rule, most hospitals do not have enough money to work with. I really think that Kaweah Delta is under-financed. I would like to see a much, much larger budget and sustained budget and one that can be supported because they are our primary source.



Probolsky Research
100 Pine Street Suite 1250
San Francisco CA 94111

San Francisco (415) 870-8150
Newport Beach (949) 855-6400
Washington DC (202) 559-0270

And as [REDACTED] had said, when you have something that needs to be done right away, you need medical help right away, so you want to have confidence in your local hospital. And you also want to have confidence in the fact that whatever it is that they're capable of handling will handle it. And if not, then they will be able to transfer you to a medical facility that can. And if you need to have that medical facility at hand quickly, it's nice to know that they've got the helicopter service as well.

Adam: Okay. [REDACTED] why is it important to you that Kaweah Delta has the financial and medical resources to provide great quality care?

[REDACTED] Because it's what we have here and [REDACTED] just said it again, when I have a medical need now, I want to know that I can have confidence in where I'm going, because frankly, I don't really have a choice. I don't think there's anywhere in Fresno that's any better than Kaweah Delta. I sometimes am reluctant to go to Stanford. It's a teaching hospital and you just never know if you're going to get someone that's not an intern or a resident, frankly. I want someone with a little experience with my medical care. I want to know that they've got the resources to help me when I need their help.

Adam: Okay. [REDACTED] why is it important to you that Kaweah Delta has the financial and medical resources to provide great quality care?

[REDACTED] I'm just going to piggy back on what the others have said. They spoke what I was thinking.

Adam: Okay. [REDACTED] why is it important to you that Kaweah Delta has the financial and medical resources to provide great quality care?

[REDACTED] We need it to be stable, sustainable, as, I think it was [REDACTED] who mentioned, keeping up on the latest technology. It also means that we have to have those fiscal resources if we want to attract high quality personnel. The best equipment in the world doesn't do any good if the people running it are terrible. And then expansion, it's got to expand. It needs to expand.

Adam: Raise your hand if you agree with [REDACTED] who said you need to have financial resources in order to attract good quality personnel. Okay. All right, [REDACTED] why is it important to you that Kaweah Delta has financial and medical resources to provide great quality care?



Probolsky Research
100 Pine Street Suite 1250
San Francisco CA 94111

San Francisco (415) 870-8150
Newport Beach (949) 855-6400
Washington DC (202) 559-0270

█ I have family here. I have kids that are going to grow up in this town and we really like it here and this is where my life is and I know that we'll be here for some time, so it'd be good to know that that's there in case of something.

Adam: Okay. █ why you think it's important for Kaweah Delta to have financial and medical resources to provide great quality care?

█ Well, like █ says, this is the only hospital we have in Visalia and with the resources and financial, they can have better equipment. We are living in a technology, they can have everything updated and it'd be something helpful for everybody in Visalia.

Adam: Okay. █ how about you? Why is it important for Kaweah Delta to have financial and medical resources?

█ Well, they're a sector of our life that directly influences the quality of our lives. Of course, I want the best for my family. I want the best available. I want it to be sustainable and I want it to be the best quality.

Adam: Okay. █ how about you? Why does Kaweah Delta need to have financial and medical resources?

█ Because as getting older █ I am appreciative of the fact that during COVID, I had my own wing to myself where nobody have COVID, but it's the fact that what was stated before, in order to get the good, high-quality, well-trained physicians into Kaweah Delta, we really need to have the new equipment, the new technology. And so, pretty much what everybody else has said goes across the board as far as I'm concerned.

Adam: Right. █ why is it important to have financial and medical resources for great quality care?

█ First, I completely agree with █ I think number one, financial resource, having it available, you can attract the best doctors out there, the best specialty. And then having resources, it reduces the number of infection at the hospital and then increases recovery rates. So if those numbers improve and it's highly publicized, people can see, "Oh, this is something that we can trust Kaweah Delta because they have the best recovery rate and the best specialty doctor ranking number one in the nation for nephrologist," or something.



Probolsky Research
100 Pine Street Suite 1250
San Francisco CA 94111

San Francisco (415) 870-8150
Newport Beach (949) 855-6400
Washington DC (202) 559-0270

Adam: Great. All right. Any facility upgrades that you know of, physical upgrades that Kaweah Delta needs to make? Let me know what you think. Anything physical that needs to happen.

█ They have the whole seismic retrofit that the bone... We had the failure of the bone a few years ago. So I presume that still needs to be done.

Adam: Okay. Anybody else?

█ Okay. My husband just went to the emergency room the beginning of May. They requested a CT scan. The machine that they put him in, he felt like was from the 1970s, the [inaudible 00:48:25] shield was broken. There were old stickers all over it, so it didn't give him any confidence when the doctors said, "Oh, you're fine." Well, are we sure? Because machine looked like it came out from the '70s, why couldn't I be placed in the new machine? There's a lot of upgrades that need to take place in the hospital. There's a lot of deep cleaning that needs to be done because the place is filthy. You walk out of there, you got to go take a shower and you don't know what you're bringing home.

Adam: Anybody else? Any physical upgrades? Okay. How about parking? Everybody think parking is perfect? You're laughing, █ Is that an upgrade that has to be made?

█ Well, they do have the structure across the street, which... I think it's kind of dangerous, actually. I think somebody has actually been run over on Court Street, crossing over to the hospital from the parking structure.

█ Yeah. [inaudible 00:49:33] dart down the street.

█ Yeah.

Adam: Okay, anybody else-

█ Parking's a disaster.

Adam: Okay, so then what kind of physical upgrades do they need to make? Give me an example.

█ Parking is a red hot mess. It's ridiculous.



Probolsky Research
100 Pine Street Suite 1250
San Francisco CA 94111

San Francisco (415) 870-8150
Newport Beach (949) 855-6400
Washington DC (202) 559-0270

█ I don't know how they're going to remedy it, because they're in a little enclosure where there's so much other infrastructure around them.

Adam: Okay. All right. Let's talk about the hospital physically. The Mineral King Wing of Kaweah Delta was built over 50 years ago, before there were personal computers, mobile phones, and before we landed on the moon. It was built in 1969. It has not been significantly updated since. The wing contains 206 of the 435 beds Kaweah Delta has in the downtown campus. There is a need for a more modern facility to better serve patients and the Mineral King Wing does not comply with state earthquake standards beyond 2030 and will need to be replaced. Kaweah Delta is in the planning stages to build a new modern hospital wing. In general, do you support or oppose a new hospital wing being built? Raise your hand if you support a new hospital wing being built.

█ I think they'd be better off with a new hospital.

Adam: Okay. So a new hospital, a new building, right?

█ Outside of where they are right now.

Adam: I see. So █ says no, █ says no. Anybody else say no? █ you say no?

█ No, I agree. We definitely a brand new facility. We're just outgrowing it.

Adam: █ why no, you don't support a new [inaudible 00:51:23] wing?

█ I'm not sure. That's just not enough data for me to say that I support something or don't support it.

Adam: Let's say, let's say you were to build it and it was free. Would you generally support a new hospital wing?

█ Oh, of course.

Adam: Okay. All right. █ how about you? Do you generally support-

█ There is no such thing as free.

Adam: I get it. I want to understand whether... █ you don't support it there at all. You think it should be moved somewhere else.



Probolsky Research
100 Pine Street Suite 1250
San Francisco CA 94111

San Francisco (415) 870-8150
Newport Beach (949) 855-6400
Washington DC (202) 559-0270

█ I think it needs a new location.

Adam: Okay. All right. It would cause a bunch of money, so let's first go to modernization. What does modernization mean to you when it comes to a hospital? Give me a couple of words █, what does modernization mean to you? What does it mean to modernize the hospital?

█ Updated, trustworthy. I'm really looking for facilities that can take care of all my medical needs.

Adam: All right. █ what does "modernize" mean to you when it comes to a hospital?

█ Well, several people mentioned technology and the latest in... The medical field is changing so fast. Having people that are aware of the changes, having the personnel and the professionals that are on the cutting edge would be very helpful along with the update of the facilities.

Adam: █ what does "modernize" mean to you when you think about a hospital?

█ Leveraging efficiency and effectiveness, so recreating the space so it's more efficient for the demands upon it now, as opposed to when it was built 60 years ago. The demands are different.

Adam: █ what does "modernize" mean to you when you think about a hospital?

█ I would definitely say we need updated technology. We need cutting edge physicians and earthquake proof. That's like a big thing with me right now. If anything happens, that's our hospital to go to if we have a major earthquake. And I know for a fact it is not earthquake ready. Stable. Anything. It's not. Half of it is, but the other half, it could flatten like pancakes.

Adam: Sure. █ what's modernization mean to you when you think about a hospital?

█ Definitely updated equipment, cutting edge technology. Interior, people walk in and they see dated stuff, they just automatically assume it's a terrible hospital, but that's not the case most of the time. It's just underfunding. But if they see this brand new facility, in their mind, they're going to say, "Oh, this hospital has money. I can trust them because they have money to take care of me."

Adam: Okay. █ what does "modernize" mean to you when it comes to a hospital?



Probolsky Research
100 Pine Street Suite 1250
San Francisco CA 94111

San Francisco (415) 870-8150
Newport Beach (949) 855-6400
Washington DC (202) 559-0270

Updated, upgraded. Updated, meaning technology and upgrading the infrastructure.

Adam: Okay. [REDACTED] what does "modernization" mean to you when it comes to a hospital?

[REDACTED] Yeah. Technology, mainly. Having more equipment, whatever is new that our hospital has the resources to acquire that. That's what modernization would be to me.

Adam: Okay. [REDACTED] "modernize", what does it mean to you?

[REDACTED] The latest medical technology.

Adam: Okay. And [REDACTED]

[REDACTED] I think everyone's pretty much covered those areas. I do know this. I've heard, maybe a couple of years ago, that the old facility, they have that earmarked for clerical and administration, which I think is fine. Which then therefore, it's necessary to have the second addition, the second tower built. So I would say the infrastructure certainly is important and then follow it up with the right technology, the latest technology, and also the staff and the professionalism that will be able to keep up and-

[REDACTED] ... and the professionalism that we'll be able to keep up and maintain and direct the technology that is being introduced.

Adam: All right.

And [REDACTED] how about you? What does modernize mean to you when you think about a hospital?

[REDACTED] Yeah, pretty much what [REDACTED] was saying, technology and having the right people that know how to use technology, and giving out the best service. Along with cleaner, updated rooms, sanitized rooms, making it feel like you're going to enjoy your stay there somewhat. Instead of knowing that you might die if they don't have the proper technology. I think technology is just the main key to it.

Adam: Raise your hand if Measure H sounds familiar to you, a ballot measure named Measure H. One, two, three. Anybody else? Measure H on the ballot, locally? All right.

So I'm going to put up on the screen a slide about Measure H and have you read it and then we'll chat in a minute. So it was a 2016 ballot measure. It was rejected by voters.



Probolsky Research
100 Pine Street Suite 1250
San Francisco CA 94111

San Francisco (415) 870-8150
Newport Beach (949) 855-6400
Washington DC (202) 559-0270

The top part is what you would have seen on the ballot. And I put this information here at the bottom.

Okay. Anybody have a sense of why Measure H failed? Anybody remember any messages against Measure H? Or just, in general, why you think it might've failed based on what you just read?

█ They were going to raise property taxes again.

Adam: Okay. Anybody else have a sense of why it failed or any messages you might've remembered against Measure H?

█

█

Adam: Okay. Anybody else recall anything on Measure H? Or just, based on this, have a sense of why it failed?

█ I think it had a lot to do with property taxes.

Adam: Okay.

█ I agree with that. Although I do remember this measure now, and I voted in favor of this measure. But I think people see \$48.70 per \$100,000 of assessed value on property, and I think they think that equates to huge property tax increases. Which really, it didn't, in my opinion.

Adam: Okay.

So Measure H, or any future bond for that matter, would only raise some of the money necessary to fund the costs of major hospital modernization and new construction. Kaweah Delta would raise other funds. So bond measure would raise some funds, but other funds would be raised through our hospital revenues, loans, grants.

Does that make sense, that if you're building a new hospital wing and modernizing, that you'd get some monies from the voters, from the property owners, but other monies from grants and loans and pay some of it from revenues from the hospital? Does that sound like a rational concept, or is there some problem with that, you think?



Probolsky Research
100 Pine Street Suite 1250
San Francisco CA 94111

San Francisco (415) 870-8150
Newport Beach (949) 855-6400
Washington DC (202) 559-0270

■■■■ says, yes. ■■■■ says, yes. ■■■■ says, maybe.

Anybody feels like they've done a bad job? Or are you just don't really know?

■■■■ I don't know.

Adam: Okay.

■■■■ I don't know.

■■■■ I feel like they did a good job with transparency with COVID, with hospital issues related to COVID. And that they really came out as transparent and connected.

Adam: Okay.

■■■■ I served in some of those roles that you're talking about. They were disingenuous. So they proposed some of these community groups as advisory groups, and presented them as looking for input. But then they never permitted any of that input to be provided. They paraded a bunch of professionals in front of the committees and talked through a lot of the information ... like you provided here ... but then refused to acknowledge even an opportunity to provide any input back from those groups.

So those groups then were left wanting, with why did you call it an advisory group, and why did you propose this as an advisory group, when you have no interest of actually hearing our input? It was a huge [crosstalk 01:03:37]-

■■■■ And that's a huge mistake. I'm in HR. You don't ask for feedback unless you're willing to act, or at least consider that feedback.

■■■■ So lots of times those are grant requirements, there are federal funding requirements that you have advisory boards. And they go through the motions and they get the sign in sheets and ...

Adam: Okay. All right, let's take a look at some information about the hospital and the new wing. I'll have you read this then we'll chat about it in a minute.

Okay. Who has something here that surprises them, interests them, they disagree with?

■■■■ I'm curious.



Probolsky Research
100 Pine Street Suite 1250
San Francisco CA 94111

San Francisco (415) 870-8150
Newport Beach (949) 855-6400
Washington DC (202) 559-0270

Adam: Okay. What makes you the most curious?

What makes me the most curious is the architect they hired and they were given more than one dozen options. And then it has the word replacing the Mineral King wing. When before that, you have, "They were selected for their track record of building lower cost hospitals that are highly efficient." So I think, to my mind, there's a difference between renovating and building.

Adam: Okay. So that's interesting. So this isn't a renovation. This is build. This is a replacement, right? So building a brand new-

Okay, replacement

Adam: Yeah. A brand new-

So does that mean tearing down what's there, or finding the property to build new?

Adam: Interesting. Okay. So that's the way you think of it in your mind. That's helpful. That's very helpful.

Anybody else? Anything that stands out to them here?

The amount of money. The outrageous amount of money that they spent to have these plans drawn up.

Adam: Now, where did you read about that or learn about that?

Okay. If they're in communication, they hired this architect, that means they have paid this architect to design the next new wing or whatever.

Adam: Yeah.

So that right there tells me money, a lot of money going out. Because we know that designing and drawing costs a lot of money, just for a simple house.

Adam: And you're uncomfortable with the idea of spending money to build the new hospital, or the new wing?

There's got to be a checks and balance system here. We can't-



Probolsky Research
100 Pine Street Suite 1250
San Francisco CA 94111

San Francisco (415) 870-8150
Newport Beach (949) 855-6400
Washington DC (202) 559-0270

Adam: What do you think has to be in place?

█ Pardon me?

Adam: What kind of check and balance do you think are necessary?

█ They can't afford to clean the hospital because a lot of it is really super dirty, but we can afford to hire someone to design a hospital for us.

Adam: Okay.

█ I'm going to have to disagree there, Adam. It costs a lot of money for an architect. We need to spend the money. I've been all over that hospital. █ has mentioned the dirtiness of that hospital several times. I'm sorry, I'm not seeing that.

█ You-

█ And I have eyes as well. So I'm not sure where that's coming from, but I completely and totally disagree with both of those statements.

Adam: Okay.

█ Also too, that's in a whole different level. That's a maintenance problem. I want to say it's at a different level, not a lower level. But when you're designing plans and trying to determine what it is that's going to meet the future needs of the community, with regards to medical and the changing medical technology that's occurring constantly, you've got to have good plans. You've got to spend money on architecture, on making sure that the structures are going to be correct, that the structures are going to be able to satisfy the needs of the community in the next 50 years.

So that just all goes part of the plan, part of the expense of putting together a new hospital, or a new wing, or an expansion of this type. So it's like, whatever it takes, you're going to have to spend it.

Adam: █, I saw you agreeing. Tell me what you're thinking.

█ Well, it's true. For any project like this, you have to employ people that come up with your options. So this architectural group, from what I gathered from this, came up with a dozen options. And who are on the committee to decide what's the best option and to crunch the numbers?



Probolsky Research
100 Pine Street Suite 1250
San Francisco CA 94111

San Francisco (415) 870-8150
Newport Beach (949) 855-6400
Washington DC (202) 559-0270

Adam: Okay, great question.

Another thing to add. Another thing too, and you think about this. I know a lot of thought and effort and planning went into the current existing expansion wing. But when you look at the heliport, that heliport was not designed to be there. Who made that mistake? Was it that it wasn't properly planned right? I just don't understand. When you see that heliport, the heliport is supposed to be on the top of the building, on the top of the new building. And to put that heliport where it's at, that's not efficient. And to me, I look at the general plans and I just see somebody made a huge mistake.

Adam: Okay.

And I'm wondering if the structural integrity of the original wing would not support that heliport?

Adam: Right.

Then I think they should have considered that in the architectural plans.

Adam: All right.

I agree.

Adam: I saw you are agreeing with the idea of needing to spend dollars on planning. Any thoughts on that?

You have to. You can't forecast the future, you can't think about the different directions to go until you have an idea of some of the different factors involved. And cost is a factor. You can't decide we're going to do this, you need to see what your options are. And what those options cost are relevant. That's all there is-

Adam: All right. Let's look at some hospital rooms here.

So what you're looking at here is the current patient room in the Mineral King wing, is a pie shaped, 118 square feet, lacks the space for visitors and modern healthcare equipment. Beds are placed up against the wall, which limits access to patient for patient care and limits the number of staff that can help a patient.

Here you have the Acequia wing. Acequia wing is a bit larger with 149 square feet, has limited space for visiting family and medical equipment.



Probolsky Research
100 Pine Street Suite 1250
San Francisco CA 94111

San Francisco (415) 870-8150
Newport Beach (949) 855-6400
Washington DC (202) 559-0270

And then here's the ideal patient room, kind of best practices, that would be in a new wing. Consistent with best practices for hospitals design. Includes larger room, about 170 square feet, has a proper bathroom facilities experience, room for medical equipment, safer overall, and allows families to stay overnight with loved ones.

Any thoughts on these different scenarios, these rooms? So this is Mineral King, Acequia, and then the new one that would be proposed.

█ Yeah. I like all the space on the new one. I think a lot of times we want our family to come visit us and they don't fit. And I'm all for it, the new layout on the new one. I think the one, our Mineral King, is just outdated. I mean, it's just too small.

Adam: Anybody else have a thought on these rooms?

█ Well, Adam, excuse me. I do believe that in 1969, the Mineral King wing was satisfactory. And it did, it served the needs. It was an unusual design and it was a little avant-garde, I believe, at the time. Definitely have outgrown it.

As I've mentioned, I do believe that they're going to convert that from medical to administrative staff or clerical, which is fine. The Acequia wing, when it was built, I think was adequate. It did make for some considerable improvements.

But as we move forward now, as our area gets big, the surface area is much, much larger population wise, I think it's really important to step it up and go for the ideal patient room now. So this is where we need to be. We do, as a community, need to be in that phase. And that's where we need to be thinking.

Adam: Anybody else have a thought on these rooms?

█ Is the-

Adam: Go ahead, █

█ ... Acequia wing, where the cardiac wing is?

█ Yes.

█ It is? Okay. Because the room for the Acequia, it's big, it's really, really big. So unfortunately, I couldn't have family visit because it was COVID, but it is a really, really big room. So that is definitely adequate.



Probolsky Research
100 Pine Street Suite 1250
San Francisco CA 94111

San Francisco (415) 870-8150
Newport Beach (949) 855-6400
Washington DC (202) 559-0270

And see, I think if something like this gets published on Facebook and Instagram to show, this is where your tax dollars going, this is what we're trying to achieve, and this is where your tax dollars going. Then I think you'll get more support from the community. Because, as a taxpayer, I like to see my tax dollar going to use. And I want this, I want this ideal room. If I see, "Okay, my tax dollars being good to use," then I'm fine with it. I don't know if that speaks for everyone, but that's how I see it.

Well, Adam, in a project this size, you need to spend some money on PR. Number one, you've got to have a plan, and-

Adam: So let's stop right there for a second, [redacted] just said we need to spend money on PR. The hospital district cannot advocate for anything ... and we'll talk about things like central bond measures in a minute ... but the hospital can't advocate for things that might show up on your ballot. They can certainly talk about what happens if a bond passes and what happens if a bond fails. But they can't spend money to advocate. They can certainly talk about education and outreach.

In a big project, like maybe a new hospital wing, is it okay for them to spend money on outreach? It may be six figures, right? They may spend hundreds of thousands of dollars to make sure that the message gets through to people like you and your neighbors. Is that okay, [redacted]

Well, here's my thought on this. I am seeing this proposal basically for the first time. I've never seen a comparisons of these rooms. But we all know that the need to expand the hospital is definitely there. But just to come out and say, "Okay, we need to raise your property taxes a certain amount of money to earn a certain amount of dollars."

Okay, we really don't know that this was the part of the plan. We need to see the direction that the hospital needs to take this, and then also propose that we need to have a bond, we're going to be doing some sourcing of grant money and whatever monies that are out there. And it's going to be for building-

Adam: All right. So [redacted] let me explain. We all look at different media, right? Some of us are on Facebook. Some of us watch TV. Some of us read the mail. Some of us read the newspaper. The way you communicate with a broad public is to reach out to them in the way that they're most comfortable, in the medium that they're used to using. That costs money.



Probolsky Research
100 Pine Street Suite 1250
San Francisco CA 94111

San Francisco (415) 870-8150
Newport Beach (949) 855-6400
Washington DC (202) 559-0270

Raise your hand if you're comfortable with the hospital district spending resources to do that outreach, to explain where we are today and where they would like to go if there were support for it? Raise your hand if you're supportive of that.

█ Let me ask you this-

Adam: No, no, just hold on, █. Just raise your hand if you're supportive of that kind of outreach at first?

█ It depends how much is being spent or budgeted for the outreach.

Adam: Okay. One, two, three, four, five, six, seven.

Okay. All right. So hold on, we got to move on because we've got a bunch of things to cover here-

█ Can we go back through for just a second, Adam, to this whole patient room thing?

Adam: What do you need? Yeah.

█: Because I don't completely agree. We're looking at this ideal patient room, but are we talking about ... what about the other things, like an increased number of MRI suites, labor and delivery being ... Granted, this is a nice aesthetic, and it's great if everybody can have as many people. But it's also really crappy if you have to wait three months for an MRI because there's just not enough facilities.

Adam: Okay.

█ So I want to know how this room is going to balance into the overall effectiveness?

Adam: That's great, █

█ The hotel ... I mean ... sorry. Well, that's what I feel like I'm getting pitched here, is a hotel.

Adam: Okay. [crosstalk 01:18:15].

█ There's so many new medical equipment that needs to fit in the room. Now we have all these medical equipment that are big, but then you don't need to transport the patient in to getting a CT scan because you can bring it to the patient.



Probolsky Research
100 Pine Street Suite 1250
San Francisco CA 94111

San Francisco (415) 870-8150
Newport Beach (949) 855-6400
Washington DC (202) 559-0270

Adam: Right.

█ Oh.

█ [crosstalk 01:18:29].

█: We don't have the space.

Adam: All right.

█ Yeah, not so much.

Adam: All right. So we're going to now talk about a couple options of how a expansion might look. So option 1, we're going to look at option 1 and option 2. And option 1 has two phases and option 2 has two phases.

So option 1 would be phase 1, this tower here. Down the bottom floor, there's a lobby and some other things. And you have a parking structure. And then the second phase, sometime later, you would have another four stories built and more parking. And this is the configuration of how it would be. Here's your costs for it. And that's one option. And I'll show it to you on the visualization. So you'd see here, option 1. Where phase 1 would be five floors and then four floors later. You'd have the parking structures over here. That's the way the plan would work. That's option 1.

Option 2 is just one tall tower, nine stories. They would build the first five floors, and then they would build the other four floors, but they would shell them. It wouldn't be built out. They'd be empty. Until the second phase where they would build out and outfit the other floors as needed, maybe provide a little more flexibility as to when they would outfit those floors. And here's the way that would look. Parking structures and one tower.

So looking back, here's option 1 where you've got the first phase and then second phase. And here's how that would look. First phase, second phase and parking.

And then option 2 would be, first five floors, we'd build the whole thing, and then outfit the second set of floors. And here's the way that would look.

Who says option 1, that you prefer the two different towers building? Raise your hand, if you say option 1 is your preference.



Probolsky Research
100 Pine Street Suite 1250
San Francisco CA 94111

San Francisco (415) 870-8150
Newport Beach (949) 855-6400
Washington DC (202) 559-0270

Okay. Raise your hand if you like option 2, the one tower option. One, two, three, four, five, six, seven. Okay.

So [REDACTED] you didn't choose one.

[REDACTED] Okay. I was thinking. I would prefer 1. Because if we do 2, then that means we have to have more ladder trucks, which means we have to expand our fire department and their equipment. Yeah.

Adam: Okay.

And [REDACTED] what's your thought? You didn't choose one.

[REDACTED] I'm stuck. I don't know which would be better. And I'm still stuck with what it's going to do to the whole area downtown.

Adam: What's your concern about what it would do to downtown?

[REDACTED] Around the hospital, it's already very difficult traffic-wise and parking-wise and mobility. Everything. And I'm just concerned that, adding to it ... a whole new hospital would be a whole lot more expensive.

But I'm just picturing what this would entail for our future, with building going on. I guess I would probably opt for the second one, if push came to shove. But I don't like either one.

Adam: Okay. So folks, the people that did intentionally choose option 2 without me forcing them, what's attractive about option 2, the single tower, to you, [REDACTED]

[REDACTED] [crosstalk 01:22:52]-

[REDACTED] Well, I think, [REDACTED] economies of scale, for one. It's a whole lot easier to build one building than two buildings. And as the Acequia tower was built, there were shelves in that tower as well. Of course, I understand and they were filling it up now. But it's a lot easier just to build the infrastructure, put the floors that you do need to actuate immediately. That's fine. And get that funded. And then fill out the rest of the building.

Adam: Thad, what's your thoughts? Why option 2? Why one tower?



Probolsky Research
100 Pine Street Suite 1250
San Francisco CA 94111

San Francisco (415) 870-8150
Newport Beach (949) 855-6400
Washington DC (202) 559-0270

Because if you do one tower, it leaves the ground space open for the second tower later on when we need to expand even more.

Adam: Okay.

what's your thoughts on why you like one tower?

Yeah, I think it's always better, and easier, like you were saying, to have that one tower. And you look at the timeframe of it, to make two it's going to take a lot more time. I would go with one.

Adam: Okay.

All right. So paying for all this needed new updating in the hospital facilities would cost half a billion dollars, \$500 million or more. Kaweah Delta ...

Adam: Half a billion dollars, \$500 million or more. Kaweah Delta does not have the money to pay for all of this and we need to raise a portion of the funds through a bond measure. As a public hospital, Kaweah Delta treats all patients regardless of their insurance and their ability to pay for services. [Tulare 01:24:19] County is among the poorest counties in California and has the highest percentage of patients covered by Medi-Cal which pays the hospital's lowest rate. As a result Kaweah Delta is paid much less than most hospitals in the state. Overall, based on what you've seen here, do you support the idea of a bond to pay for the updates needed? The new facility, a new tower too and in general, raise your hand if you support the idea of a bond to help pay for a new tower. Okay. All right. So you say no?

No, I say yes.

Adam: So what did you say Okay. All right. All right. So...

You know what Adam, I'd like to also just add sort of... I'd like to see our County figure out a way to get some financial skin in that game to, to make some contributions at a county-wide level, whether that's a tax or something. Folks aren't paying their fair share either. There's a lot of folks that are really capable of... Communities that have resources to contribute and they should be.

Adam: We'll talk about that in a minute. So the first option, option two... Actually I'm just going to go to option number two, which is the tower, because there's some difference in numbers here, but follow along with me. Option two, the single tower would cost



Probolsky Research
100 Pine Street Suite 1250
San Francisco CA 94111

San Francisco (415) 870-8150
Newport Beach (949) 855-6400
Washington DC (202) 559-0270

approximately \$542 million to fund, the hospital updates, the new facility, the new tower. Kaweah Delta would borrow as much as it could to fund the project. Assuming again, that Kaweah Delta would borrow about half the cost of the project or raise those monies through revenues, through bond, through loans, through grants, the project would cost Kaweah Delta about 220 million, and the taxpayers would pay about 220 million for phase one.

A few years later, phase two would start and Kaweah Delta would cover the costs about 51 million. And then the taxpayers through a bond would cover the costs of about 50 million. The total bond for the two bonds for taxpayers would be asked to repay, would be about \$270 million. Average property owner would pay tax of approximately \$31.93 per year for every hundred thousand dollar assessed value. And that rate would go as low as \$25.56 a year and as high as \$62.15 per year, depending on the payback, the timing. But average would be \$31.93 per hundred thousand. So let's take a house that's worth \$400,000. The homeowner would pay approximately \$127.72 cents per year.

So do you think that's reasonable and is that something that you could support? Raise your hand if that's something you could support. Keep your hand up if you're okay with that. Okay. So [REDACTED] you're not on board with that?

[REDACTED] The reason I'm not is it seems like the homeowner gets hit with everything. You're talking about... That's not a lot of money, no, but when you consider everything else that's tagged on to the homeowner as far as property taxes are concerned, it becomes a big issue. And not only that, but California's really been attacking Proposition 13. There California is wanting more of our property tax money. They're wanting to raise our property tax. So I'm in fear of that. And that's the only reason. As far as the money, the hundred and some odd dollars, that's all great. But in the aggregate of it all, I have concerns.

Adam: Do you have any idea of an alternative way of paying for a new facility?

[REDACTED] I really don't without doing some study and some investigating on it, but I'm sure there's got to be other ways. I do like the fact that [REDACTED] suggest that we need to expand the district. We definitely do, because we've got to incorporate communities that really the hospital affects. And those are the people that do need to step up and start contributing and paying, like [REDACTED] would say, their fair share.

Adam: Okay. [REDACTED] you don't support the idea of bond. Do you have a thought on how else to fund a new facility and the needed upgrades?



Probolsky Research
100 Pine Street Suite 1250
San Francisco CA 94111

San Francisco (415) 870-8150
Newport Beach (949) 855-6400
Washington DC (202) 559-0270

It boils down to, you said the bottom line would be 31 something, but it could go as much as 60 something-

Adam: No. It would fluctuate, but the average over the course of 30 years would be the \$31.

My experience is it never lands on the lowest amount. It always goes for the highest amount. And then-

Adam: No, no. I'm telling you it would be as low as 25 and as high as 61 over the course of that 30 year period. But the average will be 30 to \$32.

Yeah. So I just have a hard time believing... Okay. They want to build a hospital or a new facility, whatever, why spend the money doing a name change? That didn't need to happen. They should've just, "Hey. Let's save this. This is ridiculous to change a name that's going to cost a lot of money." So there's frivolous spending that's going on within the system that should be saved and we can figure out ways to do this without taxing others. And as someone else said, we need to get the whole area, the whole County involved in this, not just the city of Visalia.

Adam: All right. [redacted] talked about, they spent money on changing their name. Does that concern you? Do you think that was an expense... I know they have reprint signs and business cards or something. Do you think that's a concern to you?

Adam | do you know how much money was actually spent?

I didn't know that.

Adam: I don't, but [redacted] old on one second. [redacted] does that concern you at all?

I didn't know that they had spent money on that. But I think that property taxes, it's hard because I think as a homeowner, you don't want to keep paying taxes on a lot of things that come out. But I think in this case, I'm sure there's other ways to get funded for the new wing, but I think I would be on board with it. I think it's one of those things where if we're using it I think we should probably pay our fair share of it as well.

Adam: Okay. Let's take a look at some information about Kaweah Delta's finances. I want you guys to see that and we'll talk about it after we read through it.

Speaker 2: [inaudible 01:32:20].



Probolsky Research
100 Pine Street Suite 1250
San Francisco CA 94111

San Francisco (415) 870-8150
Newport Beach (949) 855-6400
Washington DC (202) 559-0270

Adam: (Silence).

Okay. Anybody surprised by this information, anything in here that was surprising to you? Anybody upset by any of this information? How about the fact that they got \$316 million sitting in the bank and they're talking about taxing your house, anybody upset about that?

█ Look at the parentheses.

Adam: What's that?

█ It's only 176 days of operating capital.

Adam: So it's important to you that they've got cash on hand reserves?

█ Absolutely.

Adam: Anybody else thinking to themselves, "I sit at my kitchen table and I sure as hell don't have 176 days worth of reserves sitting around. Why the hell should they have it?" Nobody thinks that?

█ You're a family and they're a hospital. They're serving a community. You're in charge of one family.

█ That \$316 million could save your life one day.

Adam: Okay.

█ They're also waiting anywhere from 30 to 300 days to get reimbursed for insurance.

Adam: Okay.

█ So they have to have reserves to get them through all of the delays that they have and actually getting paid.

Adam: Okay.

█ Not having reserves just isn't an option. It isn't an option.



Probolsky Research
100 Pine Street Suite 1250
San Francisco CA 94111

San Francisco (415) 870-8150
Newport Beach (949) 855-6400
Washington DC (202) 559-0270

Adam: So let's talk about, it's a couple months from now, there's an article in the newspaper about hospital expansion. You're sitting at a barbecue with some friends. And what are you going to tell people about the hospital expansion? [REDACTED] what would you say to someone about this? You don't have to sell the idea to them. Just what, in general, you're going to say about the future of the hospital to somebody.

[REDACTED] Well, I think that's a good question. Honestly, I'm not sure what I would say, but I think I would focus on the fact that that is money well spent that's going to benefit every single person in the district. And I believe as several other people have said, they need to expand the district. I'm not sure that the Kaweah Delta campus, as it stands right now is going to be viable in another 10 years. I think they're going to need to think bigger, expand the district and build a new hospital.

Adam: Okay. [REDACTED] what are you going to tell someone if the subject comes up about the future of the hospital?

[REDACTED] I think it goes back to expanding the district. I didn't realize how small it was compared to how many other counties then [inaudible 01:35:59] actually use the hospital here in town. I think they definitely need to expand that. And I think it's exciting to know that they're really thinking about it and are going to put in a new wing in there, are going to expand it. I think most people, especially with COVID hitting, they actually start thinking more about their health now and what happens if they do need to use the hospital. And I think it's a great idea that they're going to expand it, or thinking about expanding it.

Adam: [REDACTED] what would you tell somebody if the subject came up?

[REDACTED] I'd like to regress just for a moment. It's nice to know and to feel that the hospital does have reserves and the fact that it is not operating at a deficit, that I think is very comforting. And that also it's good fiduciary practice by the hospital, the board and the committees that actually do spend the money on the expenses of the hospital. It is pretty obvious that... Well, I'm going to say this, up until this meeting I really didn't know too much more about the hospital. A lot of the information you provided is a lot of insight to me. And I'm going to say the majority of the community also is not aware of this as well.

And that's why I'm saying there needs to be some kind of a campaign. And I know it costs money to get the word out and however you've got to do it to make it effective and efficient and cost effective as well. But like myself, I am totally impressed by the



Probolsky Research
100 Pine Street Suite 1250
San Francisco CA 94111

San Francisco (415) 870-8150
Newport Beach (949) 855-6400
Washington DC (202) 559-0270

numbers that I see and the information that I've learned here that I have not as an average citizen, have been totally unaware of.

Adam: Okay. [REDACTED] what would you be telling people when the subject comes up?

[REDACTED] There again, my curiosity kicks in and I'm not sure I'd be telling them anything other than how much access do we have? Is it public? Could anybody, let's say from the Times Delta or any other paper, come in and ask to see the spreadsheet to see where the breakdown-

[REDACTED] Of the profit and loss.

[REDACTED] ... of the expenses? Yeah.

Adam: Okay.

[REDACTED] Well, not the property [inaudible 01:38:27]. The expenses of the hospital itself, showing how advantageous it is for us to support this entity for our own good and for the good of community on a dollars and cents wise. Not just, I mean, you get the emotional side of it, but I would like to see a CPA look at it.

Adam: Okay.

[REDACTED] Myself.

[REDACTED] That's all public information. They're a public hospital district. You can request that any time you want and they're required by law to provide it.

Adam: So [REDACTED] tell me, when the subject comes up month from now, you're at a barbecue. What's the, 30 seconds you would tell people about the expansion of the hospital?

[REDACTED] Vote for it. We need it. We need to expand. It needs to stay in the current location. You build a new hospital someplace else, you got the downtown and all of those jobs and the tax revenue for all of those businesses downtown. The hospital is what keeps that downtown going. We don't want to move it. It needs to stay where it's at. The other issue with expanding the healthcare district is our surrounding areas within the County have their own healthcare districts. And by California law, they're not allowed to overlap.

Adam: I'll come back to you, [REDACTED]



Probolsky Research
100 Pine Street Suite 1250
San Francisco CA 94111

San Francisco (415) 870-8150
Newport Beach (949) 855-6400
Washington DC (202) 559-0270

█ So we can't expand the healthcare district, unless those other entities are willing to give up their healthcare districts.

█ You don't have to expand the healthcare district to impose some sort of County level tax that contributes to the hospital.

Adam: Sue, I'll come back to you. I promise. █ what would you tell people about the future of the hospital?

█ I'll tell them that this is the place where we live. Here's where we're raising our kids and whatever needs to be done to help our hospital, we have to do it.

Adam: Okay █ what would you tell somebody about the future of the hospital?

█ I am not an architect. I honestly don't know what the technological needs are. I think there are very few people in this community that do, but I would appeal to them about the need that everybody needs the best possible access to healthcare period. It's the bottom line equity thing.

Adam: █ what would you tell people about the future of the hospital based on what you know now?

█ That we need to upgrade the building. We need to upgrade technology, staff, we need it. They really need it.

Adam: █ what would you tell people about the future of the hospital?

█ Yeah, it something that we all need it in the community, and we all have to contribute our part. And I think I have conversations with my friends and the biggest pushback is the property tax. Because again, it's always the homeowner forking up and there was a conversation brought up. Why can't it be incorporated in sales tax? It's just that it reaches more people and the entire community will be contributing. I don't know how that works. That's why I can't really give my opinions. I'm not going to try to give your opinion, but think sales tax would be easier to give rather than property tax, because we're already paying portion of it.

Adam: Sure. So if you were in some other place... One, two, three, four, five, six, seven, eight, nine... Did we lose someone?

█ You lost the guy that was in the van.



Probolsky Research
100 Pine Street Suite 1250
San Francisco CA 94111

San Francisco (415) 870-8150
Newport Beach (949) 855-6400
Washington DC (202) 559-0270

Adam: Yeah, there you go. So if you were in LA and you have to go to the hospital, you go to the hospital and you get a bill and you pay for it. Right? And if someone from New York is in Visalia and they got to go to the hospital, they go to the hospital and they get a bill and they pay for it. What's the difference between someone who lives just outside the boundaries of the district and comes to Kaweah Health and get services and pays for it. Right? What's the difference there? Why is it such a big deal to have these boundaries and think that people outside the boundaries aren't paying their fair share? Everybody think that's really a big deal.

Well, to me, they're just paying for the service. They're not paying for the sustainability of the buildings and the doctors and everything that goes with supporting that hospital.

Adam: Well, just to be clear. Right now, the taxpayers within that boundary are repaying a bond from 2003. And the sum total of those monies that you're paying is a few million dollars, right? I mean, there's a basic property tax of 1.2 million and a bond payback of 3.1 million, right? Less than \$5 million is coming from internally. Let's look at a different way. Much of the advanced care available at Kaweah Delta, Kaweah Health, open-heart surgery, neurosurgery, cancer care, would not be available at Kaweah Delta if the hospital didn't serve patients from outside the healthcare district.

So when people come from outside the district and seek care, they help support those services. And I've heard a lot of, "Hey, we've got to have share the burden outside the district." Is that like... Go ahead,

Yeah. So that's something like it's misunderstood and my friends would see it, is that there's this small town that they're pretty underserved on the poor end, probably uninsured. And they're the one that... That's why we're arguing during a barbecue, or we talk about it. They say they'll come to the hospital, uninsured. And then we, our tax dollars, the property owners will fork up the tax to pay for the bill. And that's how they see it, is that these small town people, uninsured will come in and use the hospital and we're the one who are paying for that because they're uninsured.

Adam: Okay. So Kaweah Delta has met with surrounding healthcare districts that don't have a hospital to discuss emerging healthcare districts, which would be necessary in order to, as you were talking about, have a property tax in other parts of the County and help support the building of a new facility. How do you feel about expanding the boundaries of the healthcare district in order to include those people in paying for the property tax, to pay for the new building? Who would support the idea of expanding the boundaries? Raise your hand. Okay.



Probolsky Research
100 Pine Street Suite 1250
San Francisco CA 94111

San Francisco (415) 870-8150
Newport Beach (949) 855-6400
Washington DC (202) 559-0270

█ I think absolutely. I think that's why it measure [inaudible 01:45:57] in the first place, because that was the biggest arguments against it was that the boundaries didn't serve the entire population that uses a hospital. And I think that's why it failed.

Adam: So let's say these are elected bodies. They have their own boards, they have their own ideas of what the future should look like. What if that couldn't happen? What if there was no agreement and the other surrounding healthcare districts that don't have hospitals said, "No, we're not participating. We're not going to consolidate or however it would work." So the bond would be solely the burden of the people within the district. And of course whether you're from some other city in town in Tulare County or you're from New York, or I come from Irvine, anybody could still use the hospital. Would that be a deal breaker? Would you say, "Hey, we need this thing, but the people outside those boundaries are not paying the property tax. So I'm not going to vote for it." Who would say it's a deal breaker if the boundaries aren't expanded?

So you're still on board with it, but you'd be a little bit annoyed? Is that what I'm hearing? Okay. Nobody says it's a deal breaker? Like you can't figure out how to get the boundaries, we're still going to support this thing. █

█ I don't think it can be a deal breaker. I think there's always going to be a certain portion of the population because of socioeconomic status that just doesn't have the resources to chip in. And what are you going to do? Say, "Well, you people don't get medical care." We can't do that. That's inhumane.

Adam: All right. So I'm grateful for everybody's time. Tell me what didn't we talk about tonight? What didn't we get to that we should have talked about on this subject?

█ I want to get back to what █aid, and I'm very thankful that he did. You mentioned downtown and the harm that it would be if that hospital was abandoned, I wasn't talking about abandoning it. I was talking about having like a satellite, new facility that would still be functional.

Adam: Okay. Anybody else? Something we didn't get to tonight? Anything else you want to share?

█ As an adjunct, one of the things we have to understand too, we're not an end destination point for the medical professionals. We're just not an attractive area to attract the better, higher quality providers. And that is something unfortunately, there's nothing we can do about it. And there's no way that we can attract people and keep



Probolsky Research
100 Pine Street Suite 1250
San Francisco CA 94111

San Francisco (415) 870-8150
Newport Beach (949) 855-6400
Washington DC (202) 559-0270

them here, especially when they advance in their careers and they move on. That's something I think that whether it's money, whether it's... I don't really know how to address that, but I do really feel that there's a huge, huge deficit in the professionalism in the area. We've got great doctors, no question about it, but it's really difficult to attract the new professionals into the area. This is not a magnet.

Adam: Okay.

█ Well, and also retain the young people that leave our Valley, go get educated elsewhere, but never come back. The Valley brain drain and that's something that we've been looking at across fields for a long time. And I don't know what the answer is.

Adam: █
█
█
█

█: Thanks for the opportunity, Adam.

Adam: Yeah. Thank you. Have a good night. [crosstalk 01:50:11].



Probolsky Research
100 Pine Street Suite 1250
San Francisco CA 94111

San Francisco (415) 870-8150
Newport Beach (949) 855-6400
Washington DC (202) 559-0270

Research Objectives

- Gauge employee thoughts on a possible expansion.

Study Design

Background

- NRC Health conducted an online survey of Kaweah Health employees
- Invitations sent to recipients meeting these criteria based on list provided by Kaweah Health
- Fielded July 15 – 30, 2021
- All recipients were given the option to opt out of the study

Methodology

- 906 recipients completed the survey
- Standard error range $\pm 3.3\%$ at 95% confidence level

Email Lists	n-size	Error Range
Employee List	798	$\pm 3.5\%$
Practitioner List	51*	$\pm 13.7\%$
Advisors and Ambassadors List	57*	$\pm 13.0\%$

*please note smaller n-sizes throughout presentation

Executive Summary

- 61% of respondents are bothered that people living outside of the district do not pay taxes for the hospital that is primarily used by their community.
- After reading the presented information regarding revenue gained from those outside of the Kaweah Health care district using Kaweah Health and its help in supporting additional hospital services, 59% did not change the way they felt about non-district residents being able to access care at Kaweah Health.
- After reading the presented information about Measure H, 79% of respondents think that it failed in 2016 because people did not want to pay more taxes.
- Just over half of respondents feel like Kaweah Health has done a good job expanding their outreach and building trust in the community.
- 96% of respondents support the new hospital wing being built and 60% support a bond measure to pay for the needed updates.
- Of the two presented facility plan options, 65% prefer option two (with one tower) most.

District Expansion Awareness

78% of respondents were aware of the presented Kaweah Delta Health Care District information.

District Expansion

Kaweah Health was founded in 1961 as a type of local government agency called a hospital district. Now it is the largest hospital in Tulare County and a certified level III Trauma Center. More than 5,100 employees work for Kaweah Health plus 600 medical staff are affiliated with the hospital. With eight campuses, the hospital has over 613 beds and is the only local hospital in Visalia. Kaweah Health offers comprehensive health services including cardiac surgery, general surgery, neurosurgery, cancer treatment, mental health services, orthopedic surgery, a renowned NICU and pediatric center, and other treatments. The formal name for the government agency that governs the hospital is Kaweah Delta Health Care District and it is overseen by a five-member board of directors that is elected by the voters that live in the health care district.

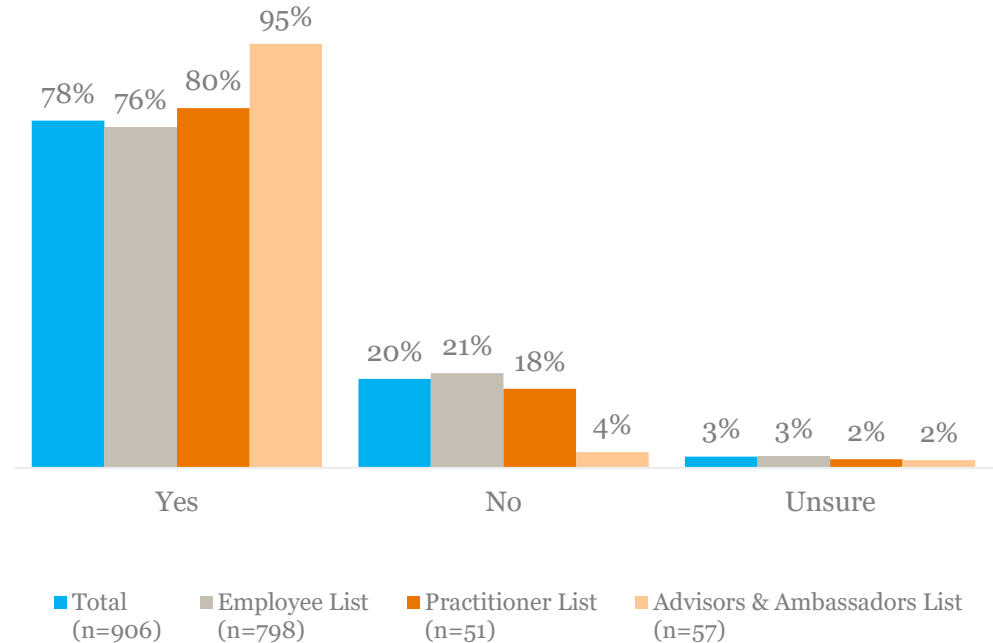

Board Member Selection Awareness

71% of respondents were aware that board members of Kaweah Health are selected by the health care district voters.

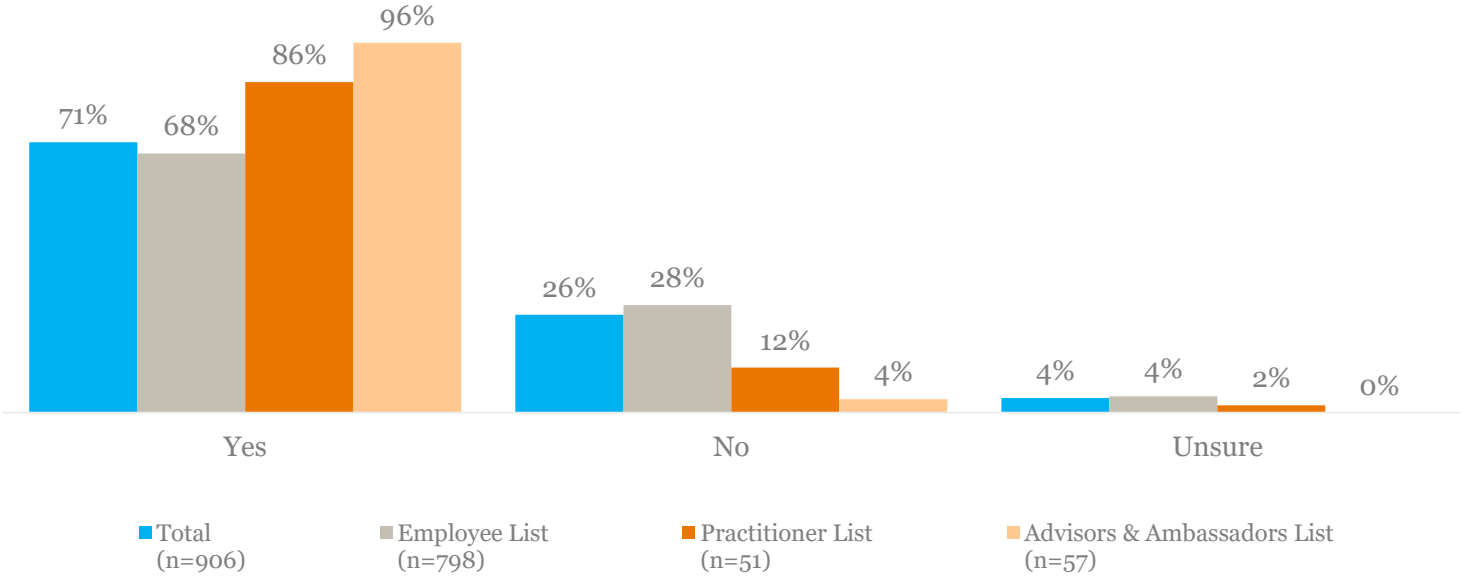

District Boundary Representation of Patient Base

53% of respondents do not think the district boundaries are a good representation of Kaweah Health’s patient base.

Voters who live within the boundaries of this map elect the Kaweah Delta Health Care District board members and pay taxes to the health care district, but anyone can be a patient at the hospital regardless of where they live.

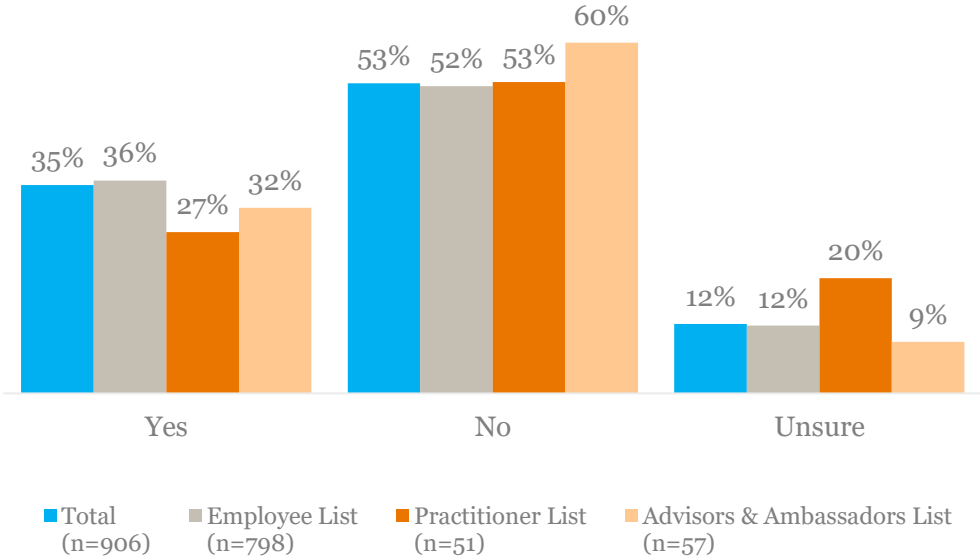
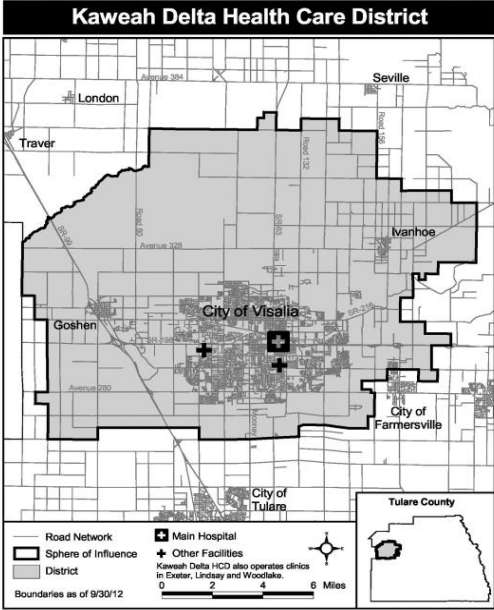

Non-District Hospital Utilization & Taxes

61% of respondents are bothered that people living outside of the district do not pay taxes for the hospital that is primarily used by their community.

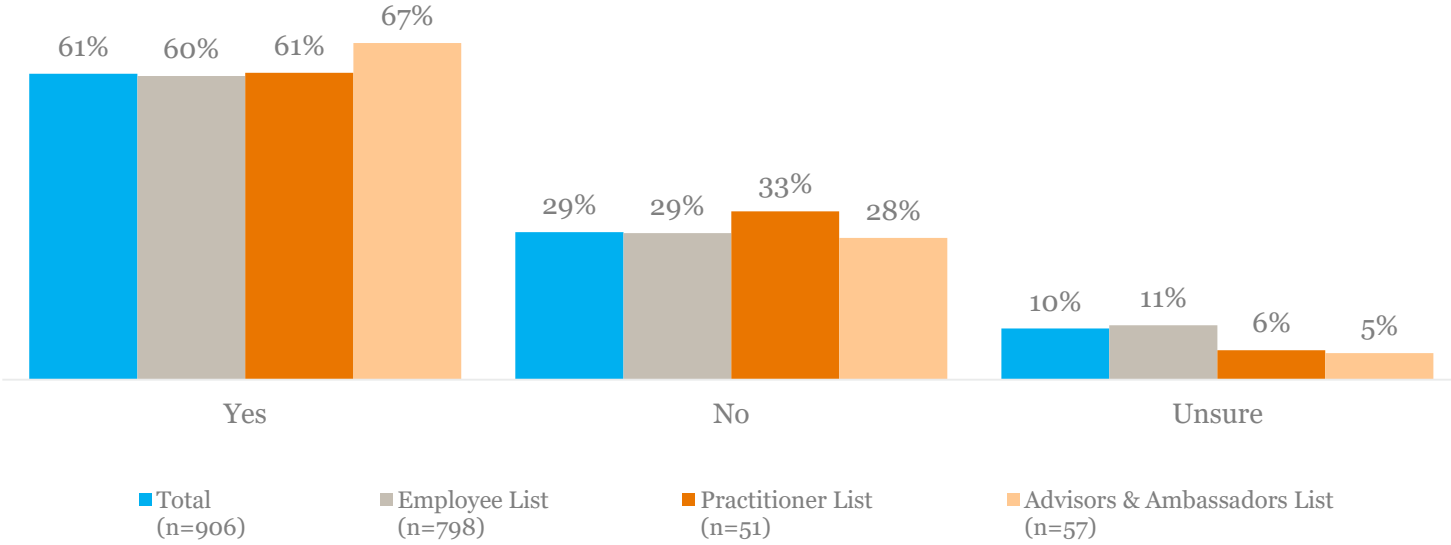

Change Towards Non-District Hospital Access

After reading the presented information regarding revenue gained from those outside of the Kaweah Health care district using Kaweah Health and its help in supporting additional hospital services, 59% did not change the way they felt about non-district residents being able to access care at Kaweah Health.

Much of the advanced care available at Kaweah Health (open heart surgery, neurosurgery, cancer care, etc.) would not be available at Kaweah Health if the hospital didn't serve patients from outside the health care district. When people from outside the district seek care at Kaweah Health, the bills they pay help to support additional services at the hospital. Kaweah Health also has five rural health clinics in surrounding cities outside of the healthcare district that help lessen non-emergent visits to the Kaweah Health Emergency Department by providing health care services to community members that do not have primary care physicians. The rural clinics produce annual revenues of \$3.1 million.

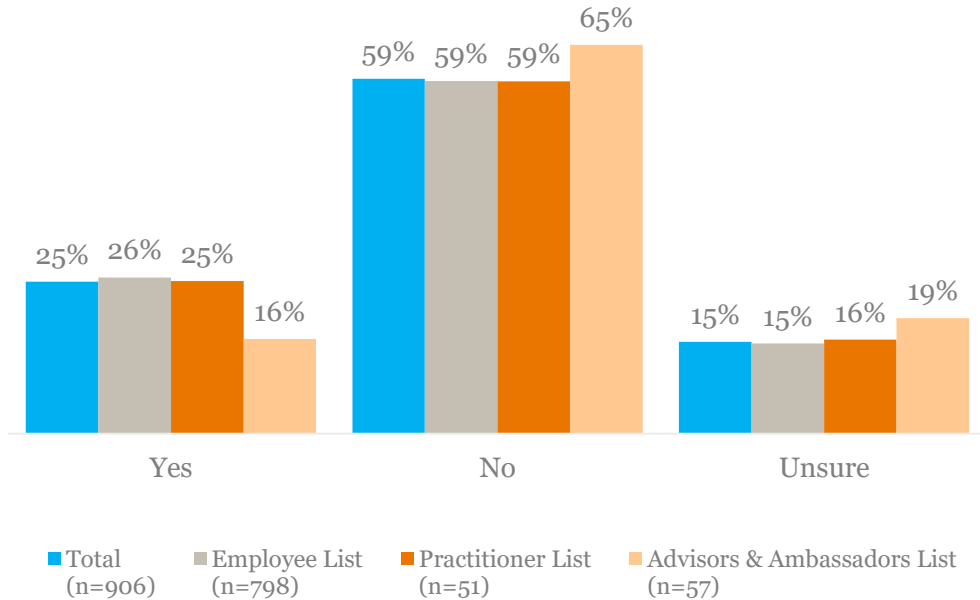

Failure Of Measure H In 2016

79% of respondents think that Measure H failed in 2016 because people did not want to pay more taxes and 54% because the voters did not like that only Kaweah Delta Health Care Districts residents paid for it.

In 2016, Measure H, a general obligation bond measure, went to the voters of Kaweah Delta Health Care District. A new facility was going to cost \$550M and, if it would have passed, the bond was going to cover \$327M and the hospital was going to pay the additional \$223M. To fund the repayment of these bonds, Measure H would have authorized an average parcel tax of \$48.70 per year per \$100,000 assessed valuation on property. In 2016 Voters rejected Measure H.

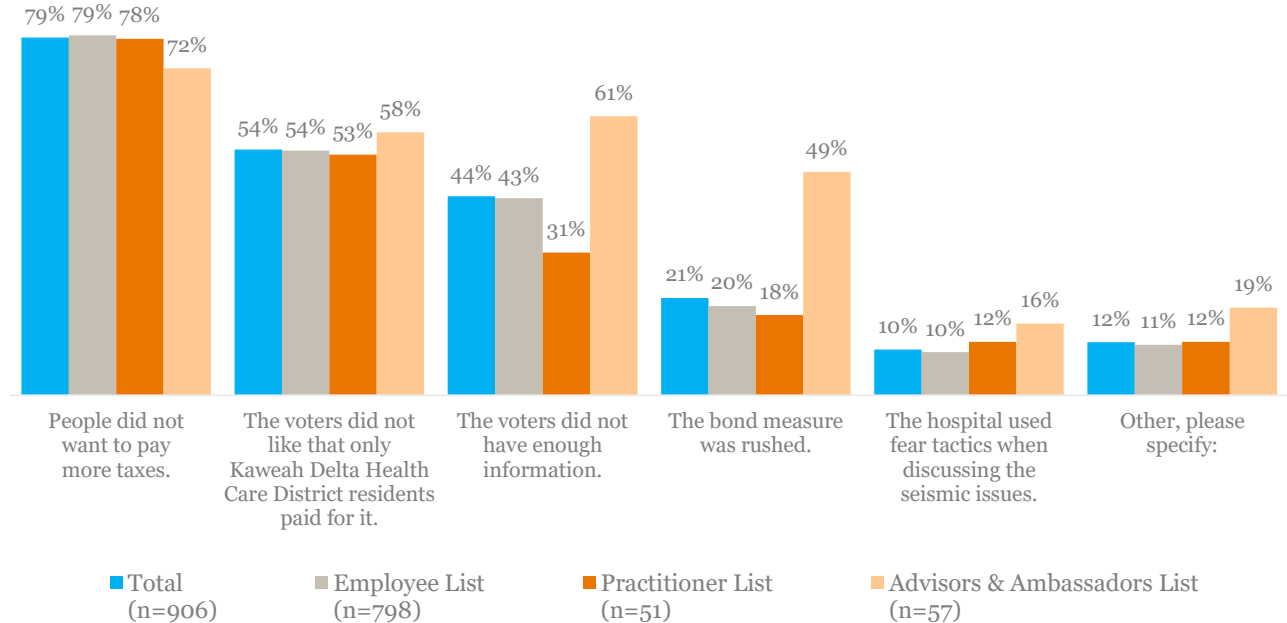

Outreach Expansion & Building Trust

53% of respondents feel like Kaweah Health has done a good job expanding their outreach and building trust in the community.

After the failure of Measure H, Kaweah Health committed to transparency and education and formed the Community Engagement Initiative.

This initiative included ambassador groups, advisory groups, and public forums such as town halls and webinars. The initial goal was to involve community members in the planning of future facilities, to listen to feedback and concerns from the community, and to involve others in important measures to help build trust. More than 200 community members and employees have participated in these community engagement groups.

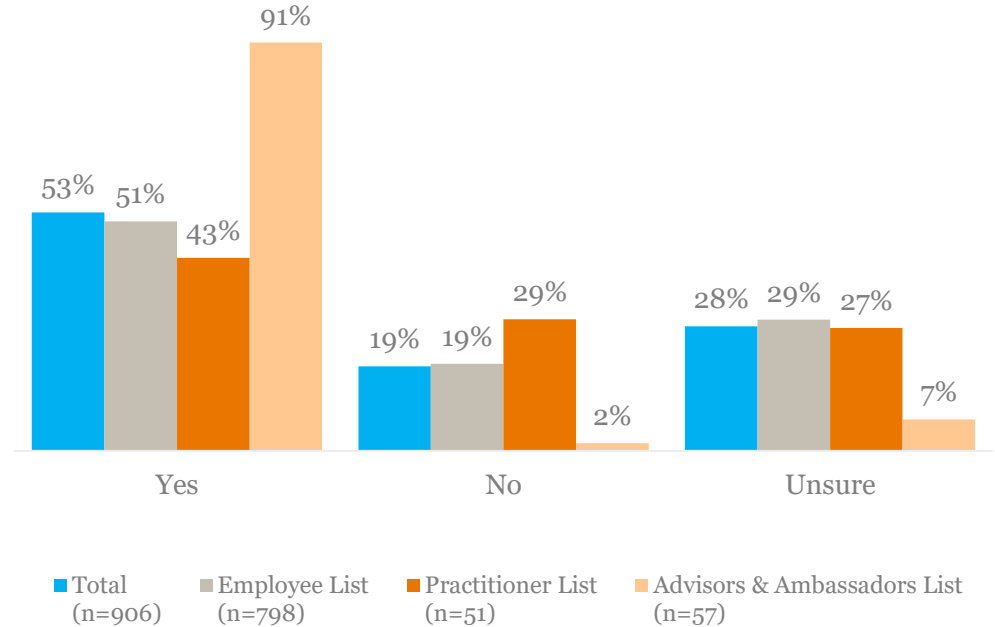

Building Of New Hospital Wing

The majority of respondents support the new hospital wing being built. Only 4% do not.

The Mineral King Wing of Kaweah Health was built over 50 years ago, before there were PCs, mobile phones, and before we landed on the moon, in 1969, and has not been significantly updated since. This wing contains 206 of the 435 beds Kaweah Health has on the downtown campus. There is a need for a more modern facility to better serve patients, and the Mineral King Wing does not comply with state earthquake standards (SB 1953) beyond 2030, meaning that we would no longer be allowed to use it for patient care, and it will need to be replaced.

To avoid having to replace the Mineral King Wing, we evaluated options to modify it to comply with State regulations. It would cost approximately \$300 million to retrofit the Mineral King Wing with large support structures on the outside of the building for earthquake safety but they would lose rooms in the process and would have to close the hospital during the potentially multi-year construction process... it really is not feasible.

If the Mineral King Wing is replaced, it could be repurposed for use as offices or perhaps a skilled nursing facility; whatever the highest and best used allowed by law.

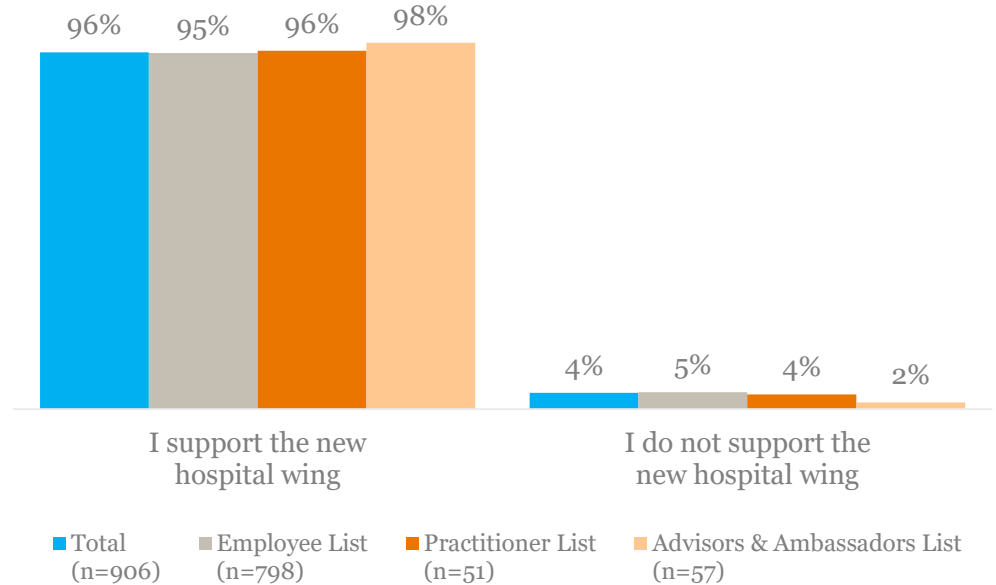

Please look over each option for the additional hospital wing described previously.

Kaweah Health has revenues of \$734M a year and the health care district receives \$1.2 million in property taxes, which is .163% of the hospital's annual revenue, and \$3.1 million to pay back Measure M bonds (passed in 2003) from property owners. By example, it costs \$2.2 million a day to operate Kaweah Health. And the District had approximately \$24.1 million in COVID-19 related losses. The district has reserves totaling approximately \$363 million (about 155 days of operating capital), which Kaweah Health must maintain to keep its strong credit rating. The District has resources to provide world-class patient care and maintain and make modest improvements to facilities. The District does not however have the resources to build a new hospital, which is needed, that would cost hundreds of millions of dollars.

Option One

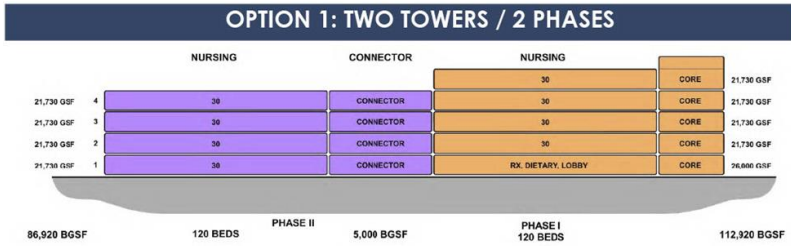

- Phase 1** : 5-Storeys, 120 beds, Pharmacy, Dietary, Lobby, 452-car Parking Structure
 : Construction Start mid 2026 - Completion by January 2030
 : \$318.5 Million (\$231 M 2020 cost + 4.5% yearly escalation to 2027 mid-point of construction+ EIR)
- Phase 2** : 4-storeys, 120 beds, 348-car Parking Structure
 : Construction Start 2036 - Completion by January 2040
 : \$365 Million (\$170 M 2020 cost + 4.5% yearly escalation to 2037 mid-point of construction + EIR)



In option one with two towers, it will cost approximately \$684 million dollars to fund hospital updates and new facilities. This would be \$319 million for Phase I and \$365 million for Phase II. Kaweah Health would work with banks and other institutions to borrow as much money as it can to fund this project. Assuming that Kaweah Health could borrow half of the money, Kaweah Health would pay for \$160 million, and taxpayers would be asked to pay for \$159 million for Phase I. Then, a few years later when Phase II is started, Kaweah Health would pay for an additional \$183 million, and taxpayers would pay for the other \$182 million. The total of the two bonds that taxpayers would be asked to repay would be approximately \$342 million. An average property owner would pay an additional tax of \$35.55 per year for every \$100,000 of assessed value (rates vary per year with the first year being \$17.30 per \$100,000 and the highest year being \$67.70 per \$100,000). So, for a \$400,000 house, the homeowner would pay approximately \$142.20 per year. (This number is based on the average amount of \$35.55)

Option Two

OPTION 2: ONE TOWER / 2 PHASES

21,730 GSF	9	SHELL	CORE	30
21,730 GSF	8	SHELL	CORE	30
21,730 GSF	7	SHELL	CORE	30
21,730 GSF	6	SHELL	CORE	30
21,730 GSF	5	BED	CORE	30
21,730 GSF	4	BED	CORE	30
21,730 GSF	3	BED	CORE	30
21,730 GSF	2	BED	CORE	30
26,000 GSF	1	RA, DIETARY, LOBBY	CORE	
199,840 BGSF				
		PHASE I	PHASE II	
		120 BEDS	120 BEDS	
			FILLED SHELL	

Phase 1 : 9-Storeys (4 shelled), 120 beds, Pharmacy, Dietary, Lobby, 500-car Parking Structure

: Construction Start mid 2026 - Completion by January 2030

: \$440 Million (\$319 M 2020 cost + 4.5% yearly escalation to 2027 mid-point of construction + EIR)

Phase 2 : Infill 4-storeys, 120 beds

: Construction Start 2036 (tentative) - Completion January 2040

: \$101.5 Million (\$48 M 2020 cost + 4.5% yearly escalation to 2037 mid-point of construction)

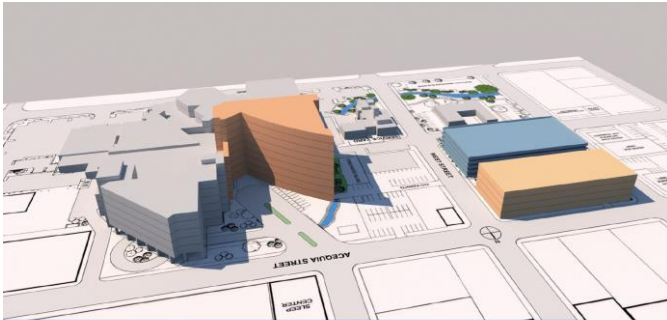

OPTION 2 - SITE VIEW

In option 2 with one tower, it would cost approximately \$542 million to fund hospital updates and new facilities. Kaweah Health would, like in Option I, would borrow as much as it can to fund this project. Assuming, again, that Kaweah Delta would borrow half of the project cost, Kaweah Health would pay for \$220 million, and taxpayers would be asked to pay for \$220 million for Phase I. Then, a few years later when Phase II is started, Kaweah Health would pay for an additional \$51 million, and taxpayers would pay for the other \$50 million. The total of the two bonds that taxpayers could be asked to repay would be approximately \$270 million. An average property owner would pay an additional tax of approximately \$31.93 per year for every \$100,000 of assessed value. (rates vary per year with the first year being \$25.56 per \$100,000 and the highest year being \$62.15 per \$100,000) So, for a \$400,000 house, the homeowner would pay approximately \$127.72 per year. (This number is based on the average amount of \$31.93 per \$100,000 assessed value)

Preferred Hospital Wing Option

Of the presented facility plans, 65% prefer option two (with one tower) most.

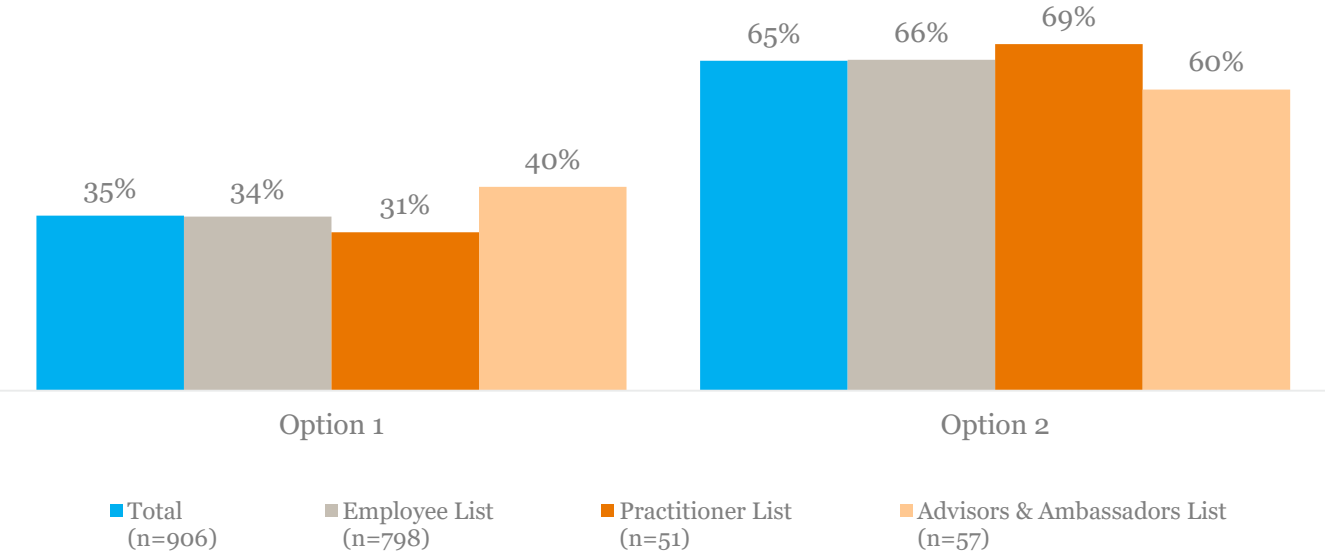

Reasons For Preferred Hospital Wing Option

Option One

More Parking, Two Towers

- ✓ “fills the bed needs and parking needs of the hospital”
- ✓ “The cost at this day in time could change with in years difference if you do not have it locked in might even be higher than the quote.”
- ✓ “From a tax payer standpoint, it's not that much more per year. We should be build and expand as much as possible as quickly as possible.”
- ✓ “Buildings are united and have various benefits solely from having connecting buildings. If going with option 2, the other building should be dividing out Mother Baby/2E/Peds/NICU instead of having adult patients there.”
- ✓ “more room, more parking , etc”
- ✓ “I like the layout... but the additional parking in option 1 is crucial to patients and employee's.”
- ✓ “more feasible evacuation if necessary, less disruption in the event of electrical or mechanical failures, less dependence on elevators”
- ✓ “The two towers makes more sense for our downtown. Also having one fully completed by 2030 gives the best patient usage”
- ✓ “I like the two towers rather than the one tower. The extra costs per year is minimal related to property taxes. As more detailed information is presented than feedback may vary. I may vary feedback but feedback is a quick look into the question.”
- ✓ “Kaweah already has poor parking capacity, and needs more.”
- ✓ “It would allow for the continued growth and medical services needed for our expanding community and its needs. The difference is negligible to the homeowner/taxpayer. If understood, and while no one likes an increase in taxes, this would be for tangible services that most use at some point in they or their families lives.”
- ✓ “Keeps the structure height more in line with the existing hospital. Provides more future parking for patients, visitors, and employees.”
- ✓ “More parking, one tower might seem too high? Probably better to have two towers in the long run”

Option Two

One Building, Less Cost

- ✓ “Less cost to the taxpayers who will be voting on this. Especially in these Covid times we have already had several financial burdens”
- ✓ “Smaller footprint. Lower cost.”
- ✓ “Less buildings which bodes to the Kaweah is taking over everything. Also cheaper up front.
- ✓ “Would prefer a smaller footprint in the already crowded downtown area.”
- ✓ “Does not take away parking that was just built”
- ✓ “I believe it is easier to transfer patients in one building instead of two. In addition, it takes less ground space and if more space is needed than it can be rebuild in the future.”
- ✓ “Less cost, so easier to get funding.”
- ✓ “I like the idea building once and filling in as needed and the money is available. Building costs will only go up.”
- ✓ “logistically, one taller tower makes more sense. it also costs less overall.”
- ✓ “It's cheaper but still fulfills the hospital / community needs.”
- ✓ “Less cost overall, seems the more fiscally responsible option”
- ✓ “As a health care worker, going up/down in the same building is much easier than going from building to building, especially if there aren't easy pass-throughs in between. This is especially important for people who respond to codes.”
- ✓ “To me makes sense to take up less land and build higher and leave room for growth after 2040. Also net impact to the tax payers is less.”
- ✓ “Less cost and utilizes less land for the 240 bed renovation.”
- ✓ “Seems more ergonomically sound and efficient rather than having 2 separate buildings”
- ✓ “Cheaper, smaller foot print which preserves more land around the facility for green spaces, etc. Also becomes a dominant physical feature in the skyline people will clearly see driving by on HWY 198. This last point I think brings intangible value. Throughout human history the height of buildings inspires societies and has always been a sign of greatness.”

Support Or Opposition To A Bond Measure For Updates

60% of respondents support a bond measure to pay for the needed updates.

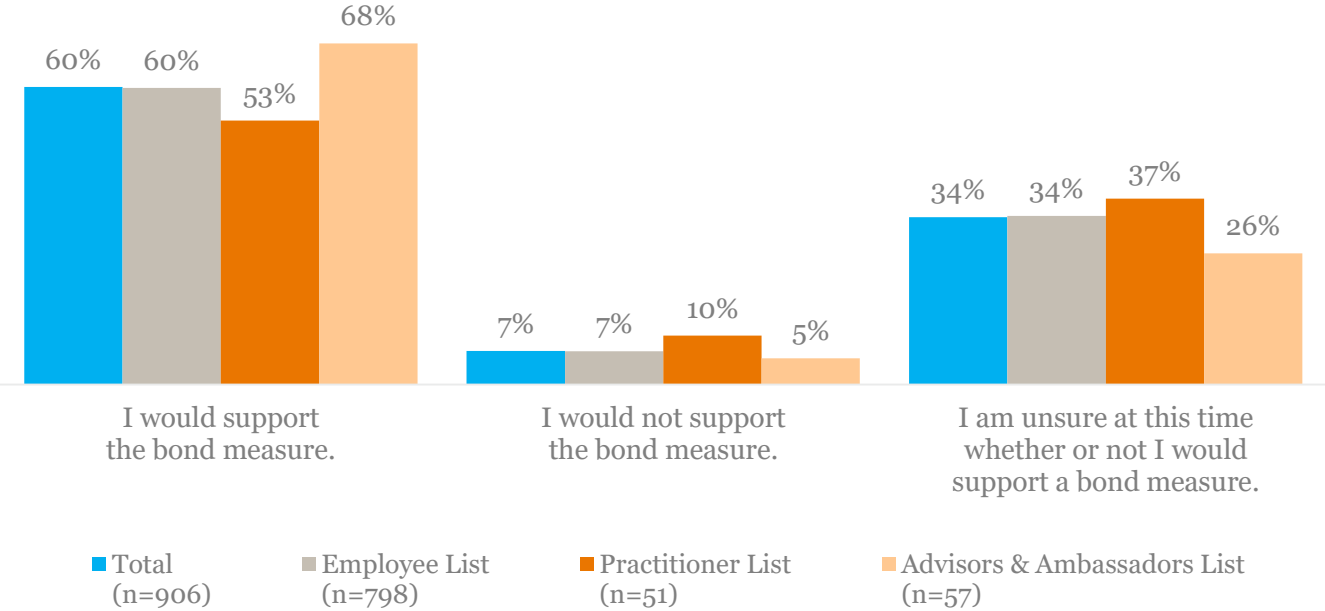

Key Takeaways

1

61% of respondents are bothered that people living outside of the district do not pay taxes for the hospital that is primarily used by their community and learning about revenue gained from those outside of the district using Kaweah Health (from their paid bills being used to support additional hospital services) did not change how 59% of respondents felt about non-district residents being able to access care at Kaweah Health.

2

96% of respondents support the new hospital wing being built. Those who are supportive (unaided) of Kaweah Health paying for a large portion of the new hospital wing from revenues and other sources primarily feel that the addition is long overdue and will benefit the hospital in the long run. Those who are not supportive feel (unaided) that the employee jobs/pay will take a hit if Kaweah needs to use expenses for the new wing and that all communities who use the hospital should contribute.

3

Of the presented facility plans, 65% prefer option two (with one tower) most, primarily because they feel keeping everything in one building is easier for patients and staff and that one building will cost less for Kaweah Health and for community taxpayers.

Demographics

Gender

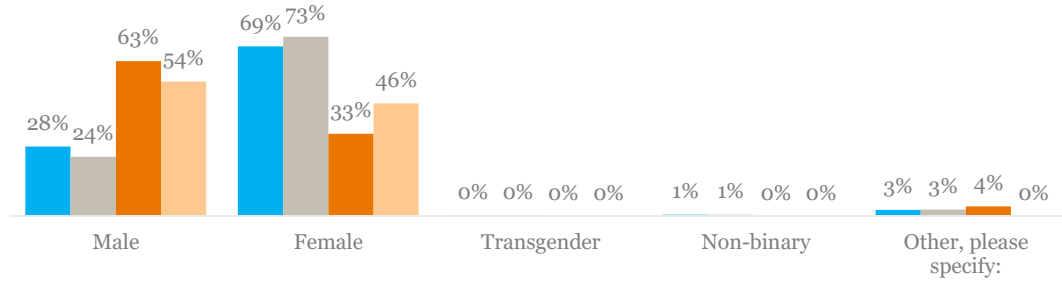

Age

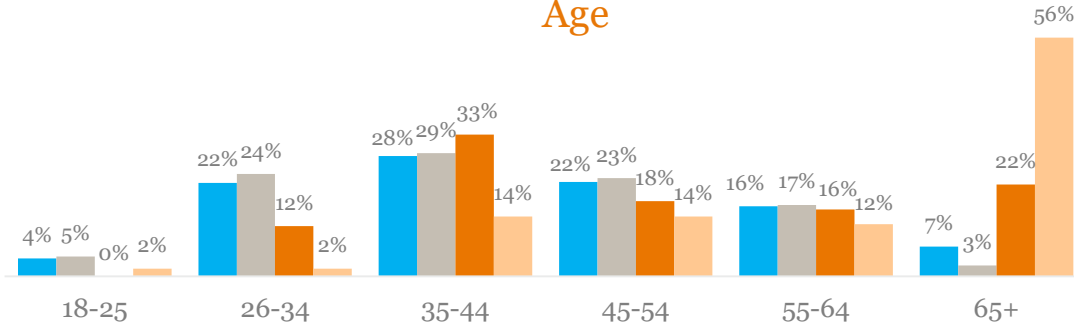

Geography

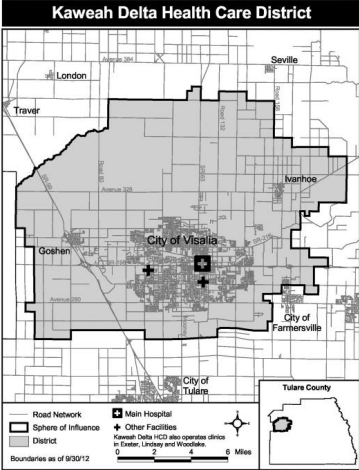

Do you live within the Kaweah Delta Health Care District outlined above?

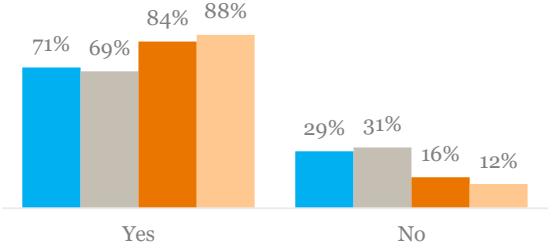

Community Engagement Plan for Master Facility Plan/GO Bond

June/July
2021

- Probolsky Online Focus Groups (5)
- Employee Survey
- Physician Survey
- Community Engagement Participant Survey

August / September
2021

- Present Results of survey/focus groups to Board of Directors.
- Review, brainstorm, and develop communication strategy based on Board direction.
- Hold in-person focus groups with community groups. (Realtors, farmers, young professionals, physicians, etc.)
- Create web content on the Community Engagement page and open community survey. Page will include elevation plan photos with information for each option. (Can RBB make these 3D?) Include Community Engagement timeline, since 2017, with drop-downs that show accomplishments of each group.

October 2021

- Board of Directors to decide on plan and whether or not to move forward with a General Obligation Bond (GO Bond).
- Build GO Bond Community Advisory Committee. (advisory group through 2022)
- Take 2020 Economic Impact Report and use the information for messaging KH's support of the city & downtown.
- Hold Community Engagement Gathering and invite Gary Hicks to educate our groups on why we need a GO Bond and the legalities around it. *(If COVID allows - might have to be virtual)* Add Latino Community Ambassador Group.

November 2021

- Put article in VTD and The Sun Gazette that shows plans and details of the work that has taken place over the last couple of years. (Hospital of the Future)
- Form GO Bond Employee/Physician Committee. (advisory group through 2022)
- Hold Community Town Hall and present plan.
- Prepare presentation for community organizations and schedule speaking engagements.

December 2021-
February 2022

- Hire GO Bond consulting firm.
- Form an employee committee to give design feedback.
- Get representative on speaking circuit for all service organizations, City Council, Board of Sup., VUSD, VEDC, etc.
- Begin social media campaign.
- Hold Town Hall.
- Raise funds for GO Bond effort. *(revive Friends of Kaweah fund)*

March - November
2022

- GO Bond Campaign (determined with assistance of GO Bond consultant).
- Increase community engagement efforts. (service clubs, town halls, polling, surveys, etc.)
- Coordinate with other neighboring health care districts.
- Ballot application deadline is 7/1-8/15. (County will post actual date on website around Feb. or March of 2022)